

# BLACK/DISTRESSED WAXED PINE SANTOS DROP LEAF COFFEE TABLE ASSEMBLY INSTRUCTIONS

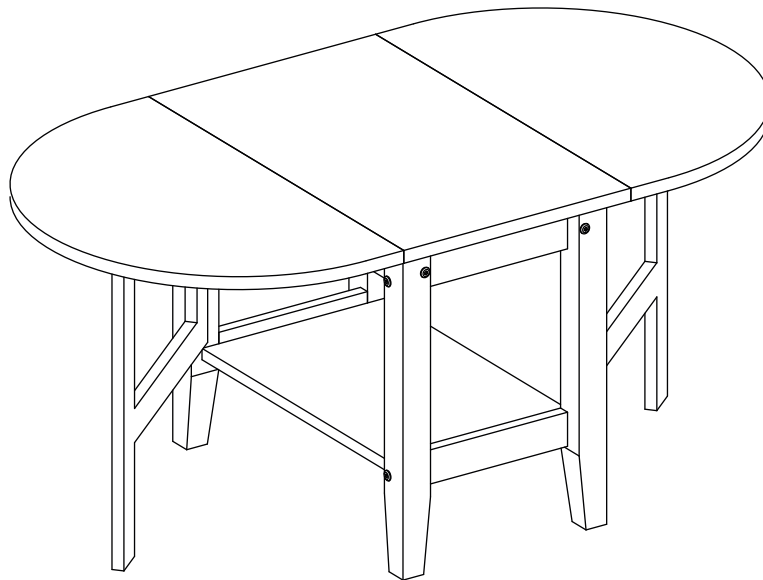

## **IMPORTANT FOR DOMESTIC USE ONLY**

**PLEASE READ BEFORE YOU CONTINUE FURTHER**

## **CARE AND MAINTENANCE**

- After unpacking this product please keep the original packaging incase it needs to be returned for any reason.
- Please ensure all fittings and parts are present before commencing with assembly.
- We recommend that you lay a blanket or sheet on the floor to avoid damage to both your floor and the product.
- We strongly recommend that you keep children away from your work area.
- Assemble this product as close to its final position as possible.
- Never drag or push products as this could cause damage to the joints making it inferior.
- Do not drag or push items across your furniture as this may cause the surface to scratch.
- Do not place this product next to a radiator or in direct sunlight.
- Wood is a natural product and may expand if subjected to damp and may shrink or crack if subjected to heat. Therefore it is recommended that room temperature is maintained, with no sudden temperature fluctuations.
- Make sure any spillage is wiped off immediately.
- Do not place hot or chilled items directly onto the surface, use a place mat or marking will occur.
- For general cleaning use a soft cotton or microfibre cloth, and do not use detergents of any kind.
- Do not place on a wet or damp floor as staining may occur to your floor.
- From time to time it maybe necessary to tighten fittings, regular inspections should be carried out.

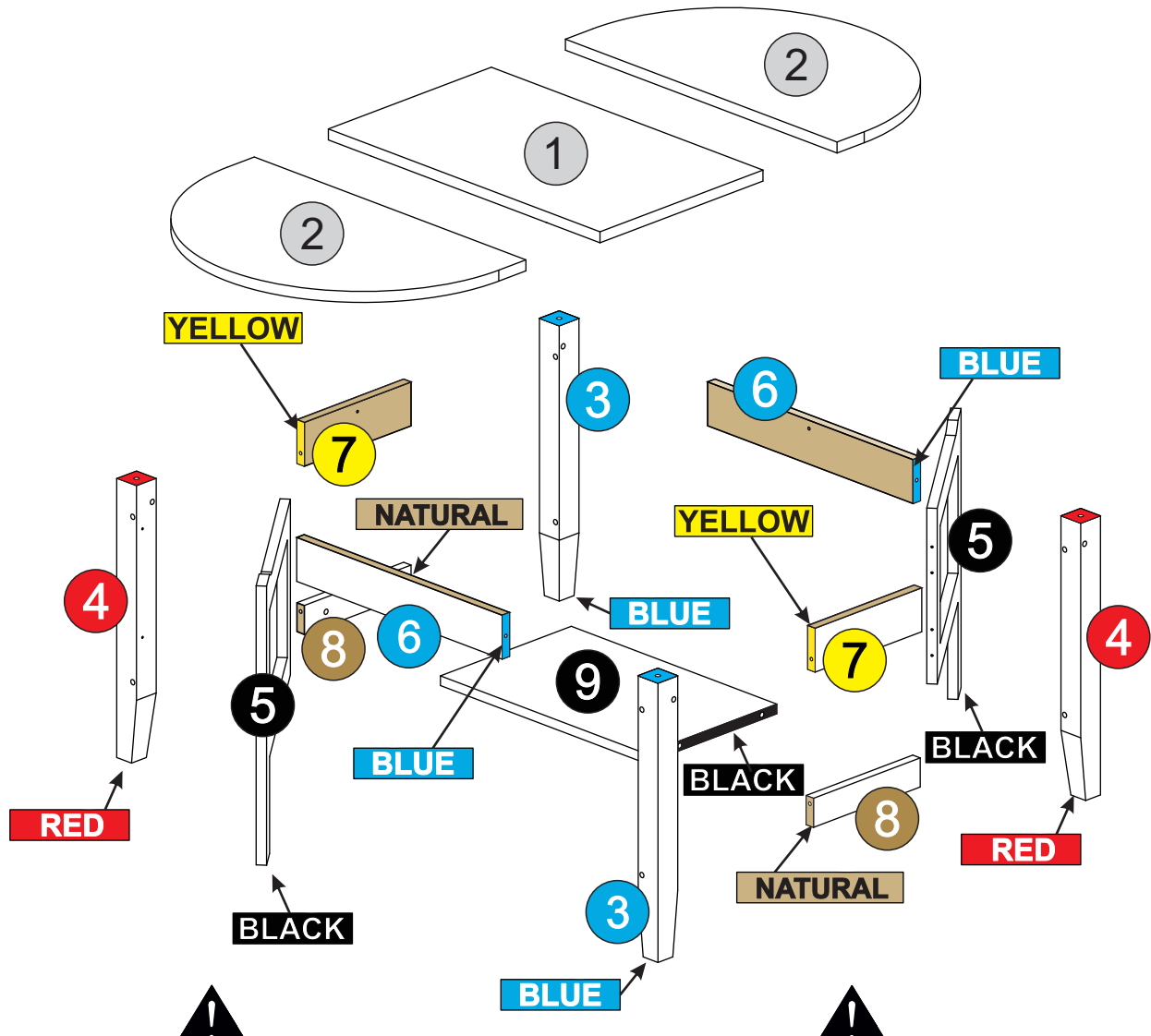

**!**  
 \* Use of power tools to assemble this product will invalidate any claim and damage this product making it unsafe !!!  
 \* Please assemble on a clean soft surface to avoid damage.







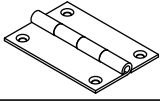
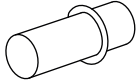

**!**  
 \* Please check contents and read the instructions before commencing assembly.  
 \* Assemble this product following the enclosed instructions carefully.  
 \* Please take care to avoid damaging panels during assembly.

### PARTS LIST

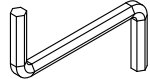
**Please Note:**  
 The highlighted parts below have been stamped with the part number to help identify them during assembly

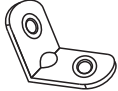
Part Number	Part Code	Part Description	Quantity	Carton
1	S300-301-079-KK1-01	Centre Top (NUMBER)	1	1/1
2	S300-301-079-KK1-02	Side Top (NUMBER)	2	1/1
3	S300-301-079-KK1-03	Post (BLUE)	2	1/1
4	S300-301-079-KK1-04	Post With Pre-Holes (RED)	2	1/1
5	S300-301-079-KK1-05	Table Top Support Leg (BLACK)	2	1/1
6	S300-301-079-KK1-06	Side Crossbar (BLUE)	2	1/1
7	S300-301-079-KK1-07	Front/Rear Lower Crossbar (YELLOW)	2	1/1
8	S300-301-079-KK1-08	Front/Rear Lower Crossbar (NATURAL)	2	1/1
9	S300-301-079-KK1-09	Shelf (BLACK)	1	1/1

## FITTINGS

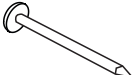
<b>A</b>		<b>08</b>	<b>F</b>		<b>02</b>
<b>B</b>	 <b>Ø3,5 x 14mm</b>	<b>50</b>	<b>G</b>		<b>01</b>
<b>C</b>	 <b>Ø8 x 30mm</b>	<b>10</b>	<b>H</b>		<b>08</b>
<b>D</b>	 <b>Ø7 x 70mm</b>	<b>12</b>	<b>I</b>		<b>01</b>
<b>E</b>		<b>02</b>	<b>J</b>	 <b>Ø10 x 10</b>	<b>02</b>

## TOOLS REQUIRED

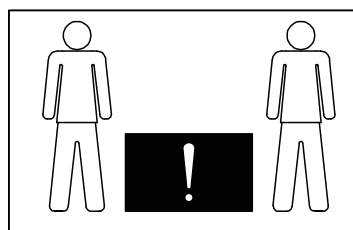
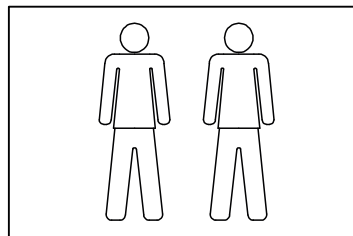
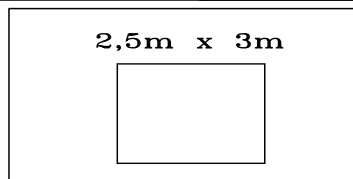
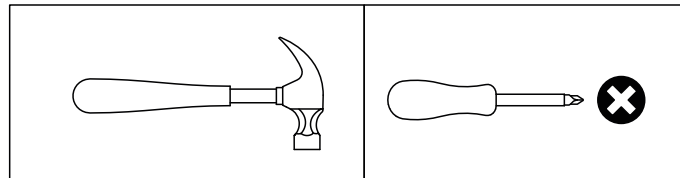





# STEP 1

## PARTS REQUIRED

6 - SIDE CROSSBAR (BLUE)	x2
7 - FRONT/REAR UPPER CROSSBAR (YELLOW)x2	
9 - SHELF (BLACK)	x1

## HARDWARE REQUIRED

B	 Ø3,5 x 14mm	08
C	 Ø8 x 30mm	04
I		01
H		08

## TOOLS REQUIRED

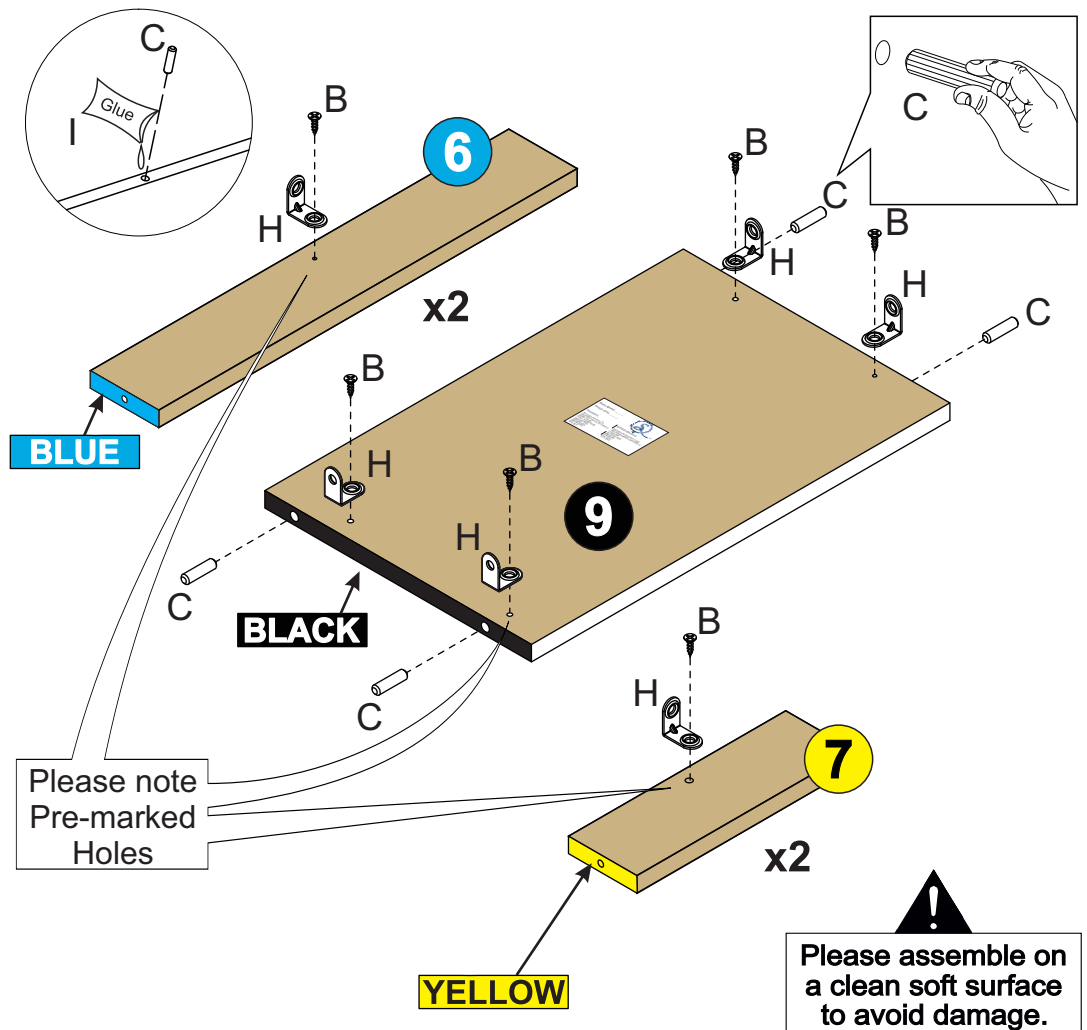
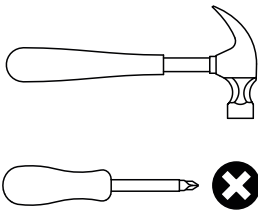



# STEP 2

## PARTS REQUIRED

3 - POST (BLUE)	x2
4 - POST WITH PRE-HOLES (RED)	x2
7 - FRONT/REAR UPPER CROSSBAR (YELLOW)x2	
8 - FRONT/REAR LOWER CROSSBAR (NATURAL)x2	

## HARDWARE REQUIRED

C	 Ø8 x 30mm	04
D	 Ø7 x 70mm	08

## TOOLS REQUIRED

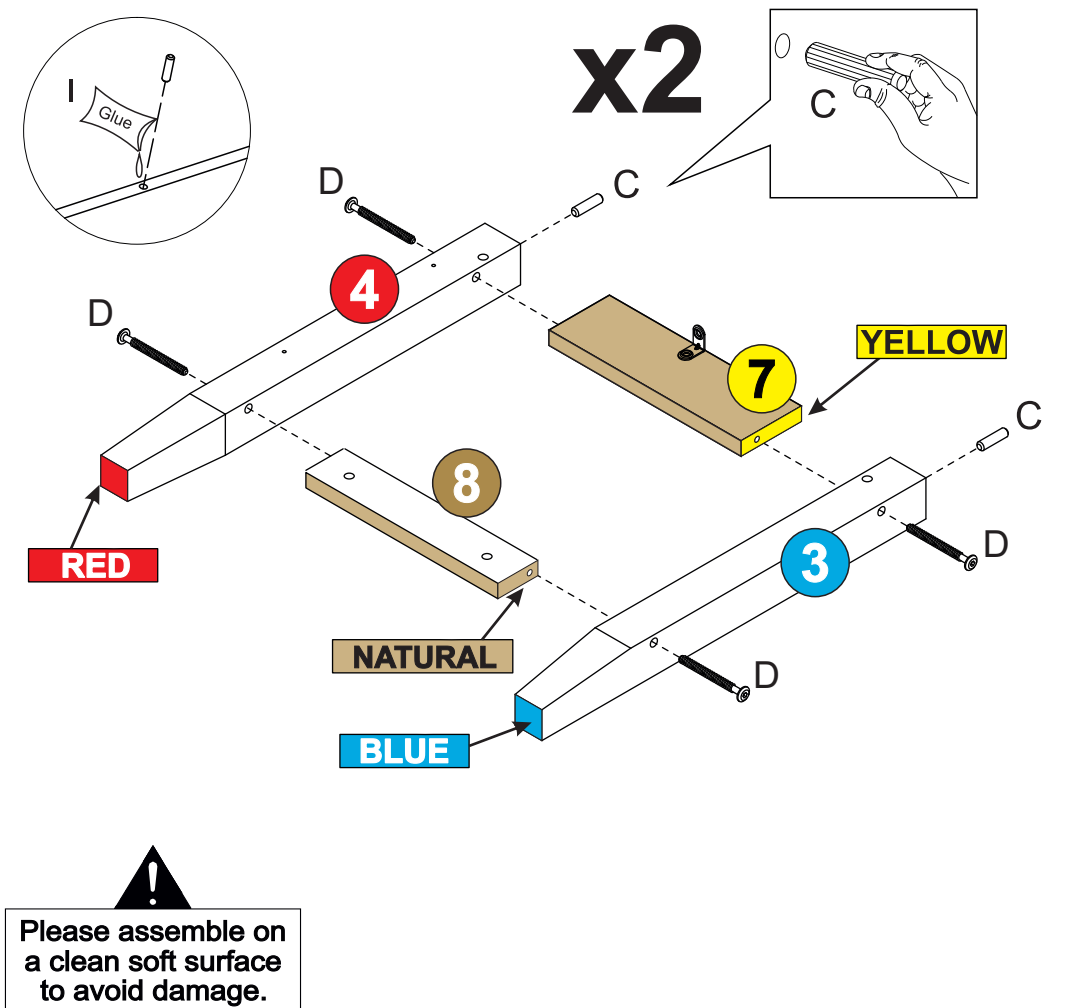
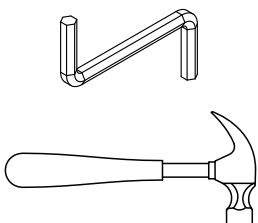

# STEP 3

## PARTS REQUIRED

6 - SIDE CROSSBAR (BLUE) x2

9 - SHELF (BLACK) x1

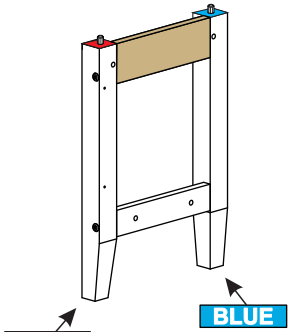

## HARDWARE REQUIRED

B  02  
Ø3.5 x 14mm

D  02  
Ø7 x 70mm

## TOOLS REQUIRED

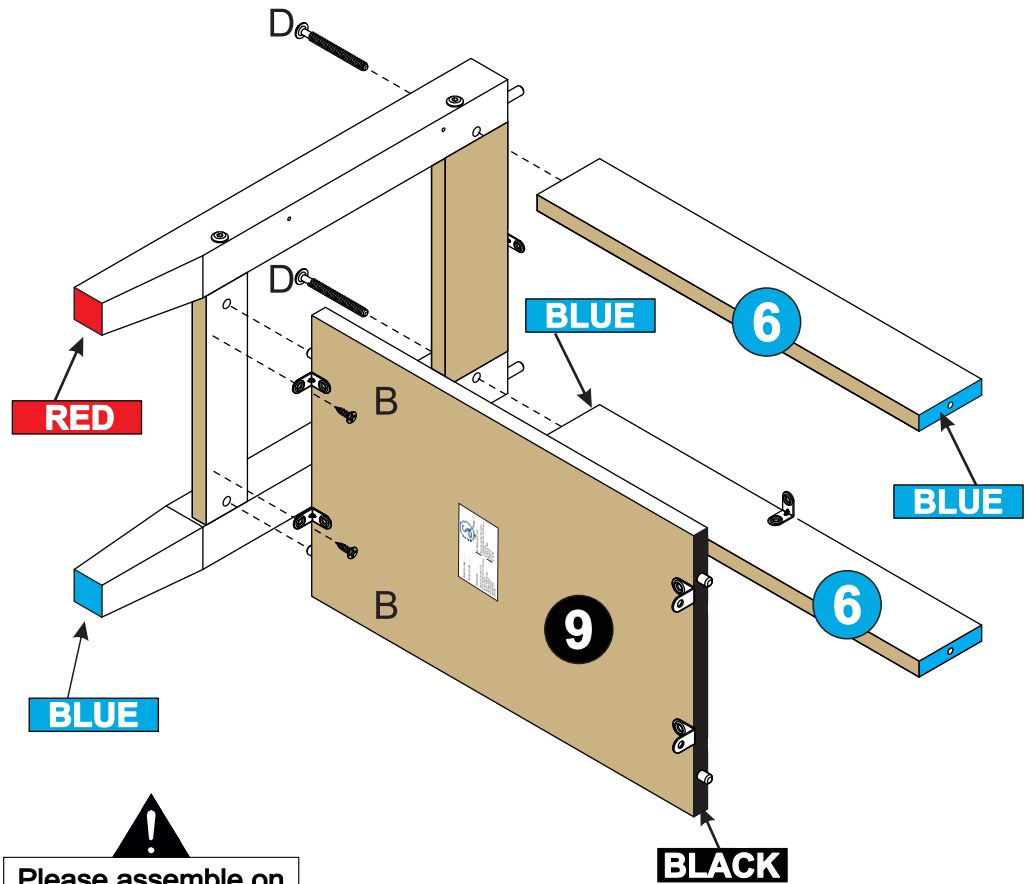
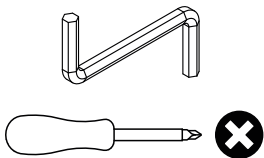

 Please assemble on a clean soft surface to avoid damage.

# STEP 4

## PARTS REQUIRED

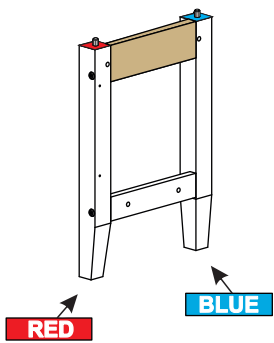

## HARDWARE REQUIRED

B  02  
Ø3.5 x 14mm

D  02  
Ø7 x 70mm

## TOOLS REQUIRED

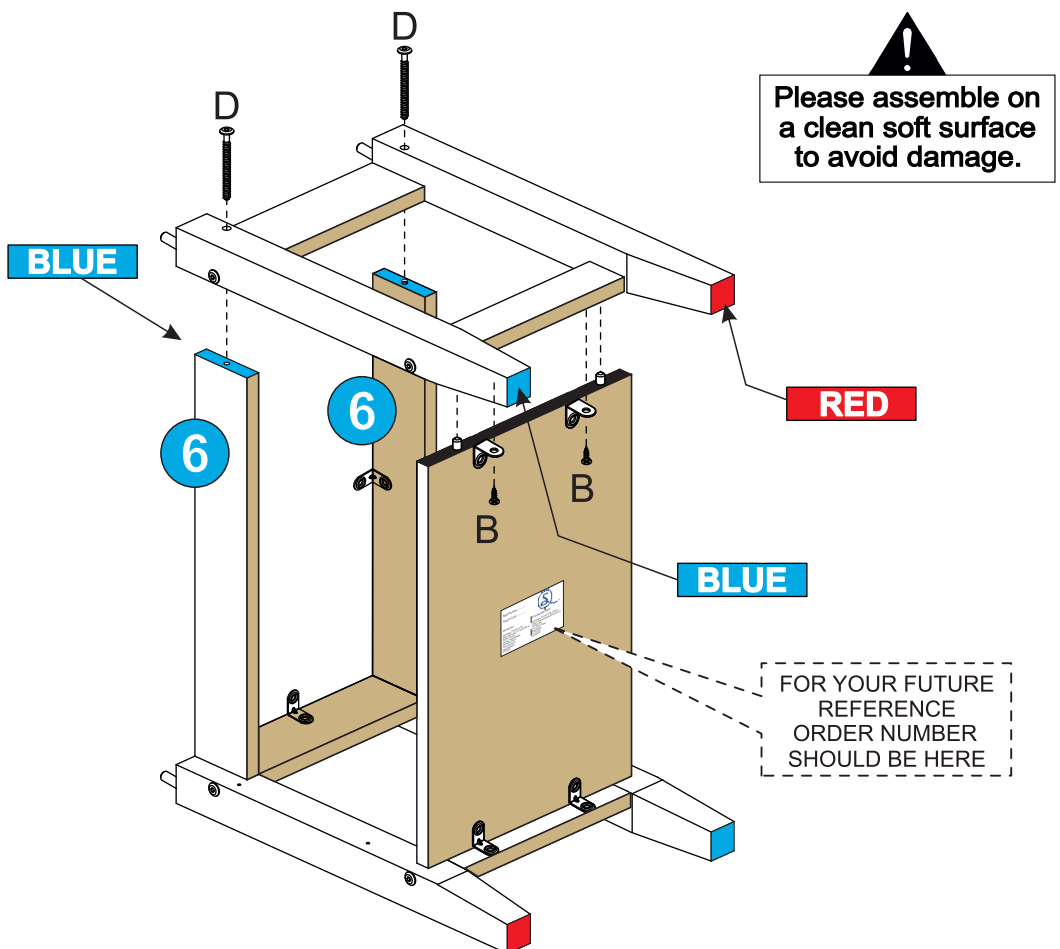
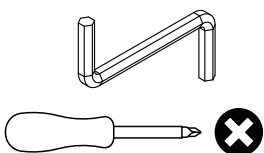

 Please assemble on a clean soft surface to avoid damage.

FOR YOUR FUTURE REFERENCE ORDER NUMBER SHOULD BE HERE

# STEP 5

PARTS REQUIRED

1 - CENTRE TOP x1

HARDWARE REQUIRED

A  04

B  08  
Ø3,5 x 14mm

TOOLS REQUIRED

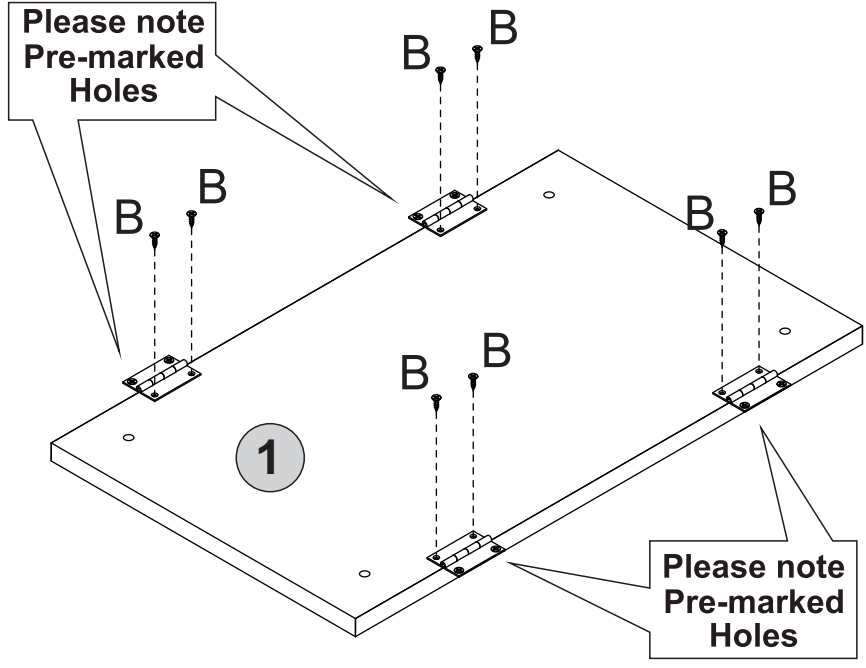
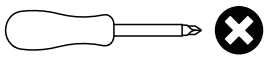

 Please assemble on a clean soft surface to avoid damage.

# STEP 6

PARTS REQUIRED

1 - CENTRE TOP x1

2 - SIDE TOP x2

HARDWARE REQUIRED

B  08  
Ø3,5 x 14mm

F  02

TOOLS REQUIRED

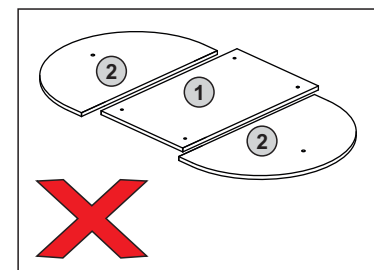
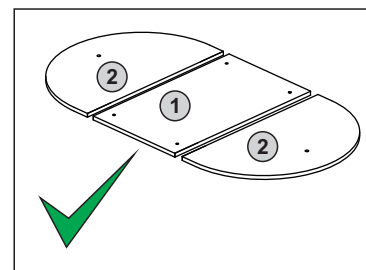
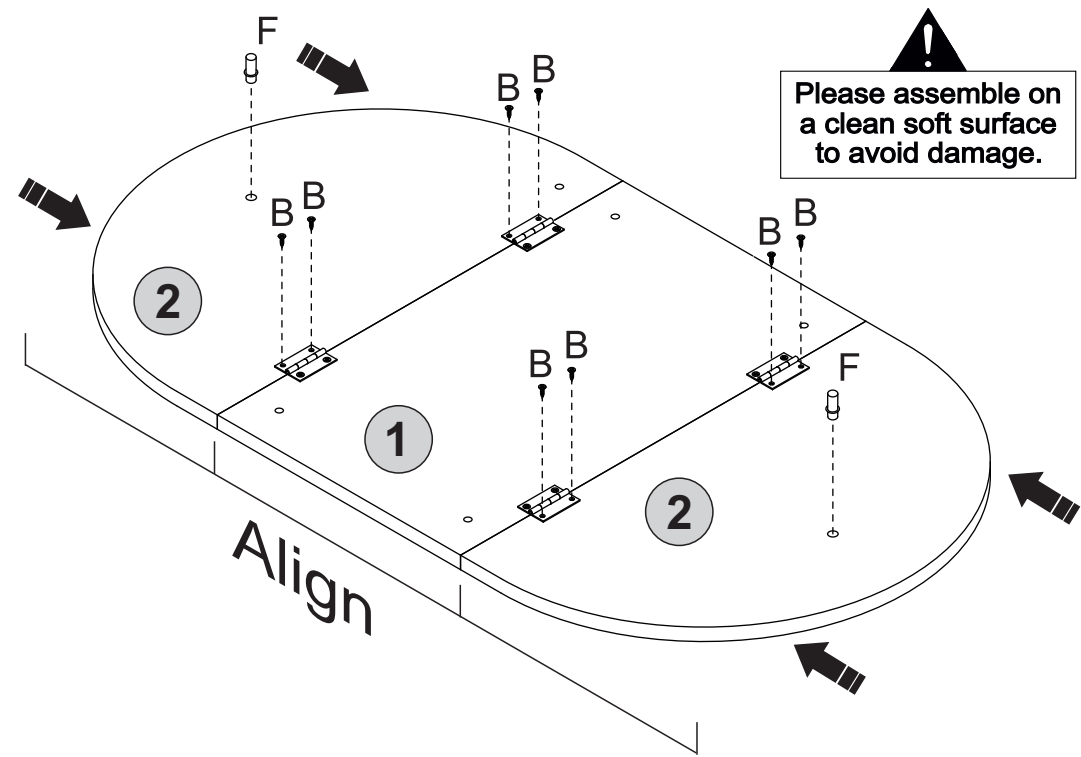
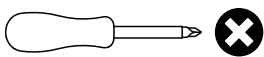

# STEP 7

## PARTS REQUIRED

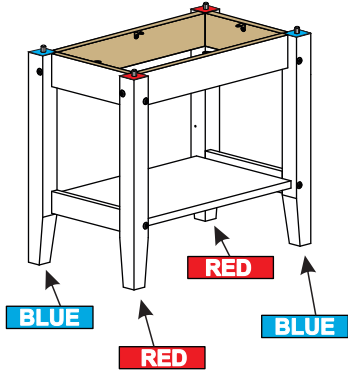
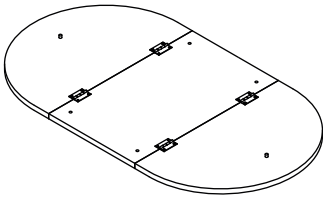

## HARDWARE REQUIRED

B	 Ø3,5 x 14mm	04
---	---	----

## TOOLS REQUIRED

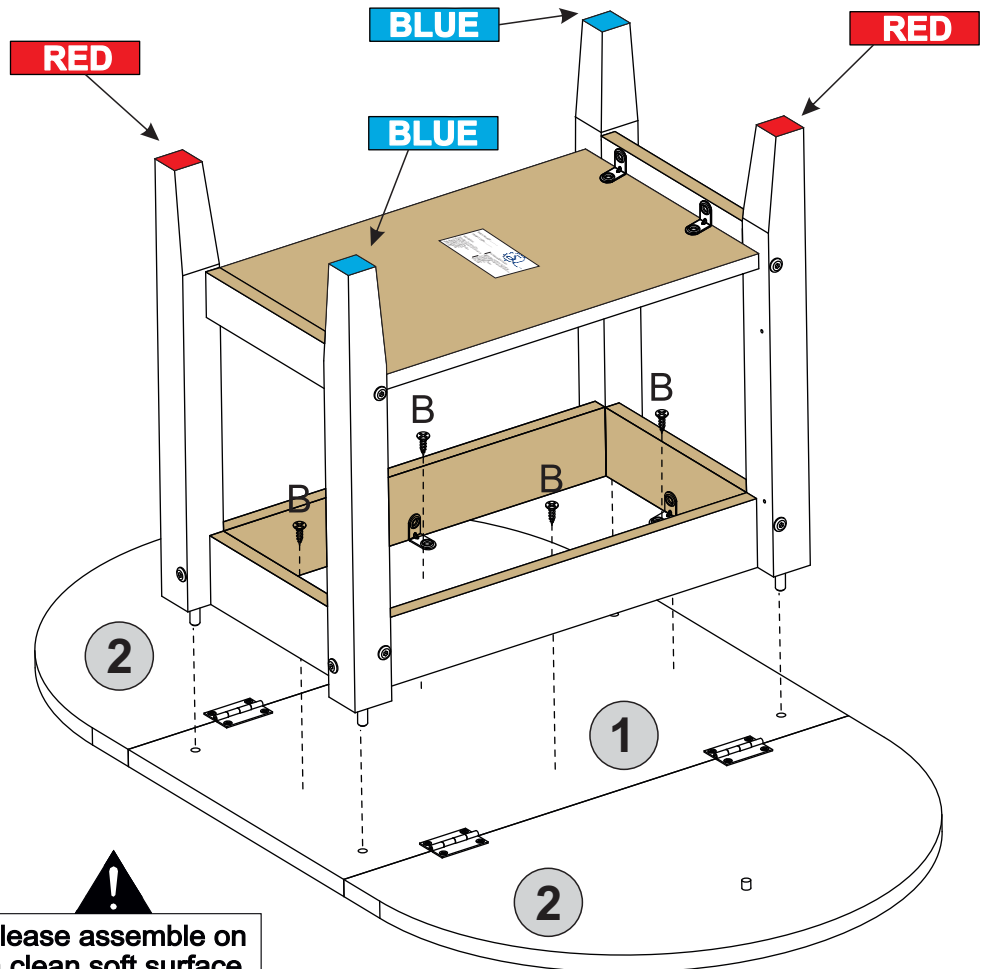
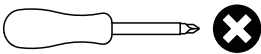

**!**  
Please assemble on a clean soft surface to avoid damage.

# STEP 8

## PARTS REQUIRED

5	TABLE TOP SUPPORT LEG (BLACK) x2	
---	----------------------------------	--

## HARDWARE REQUIRED

A		04
---	---	----

B	 Ø3,5 x 14mm	08
---	---	----

E		02
---	---	----

J	 Ø10 x 10	02
---	--	----

## TOOLS REQUIRED

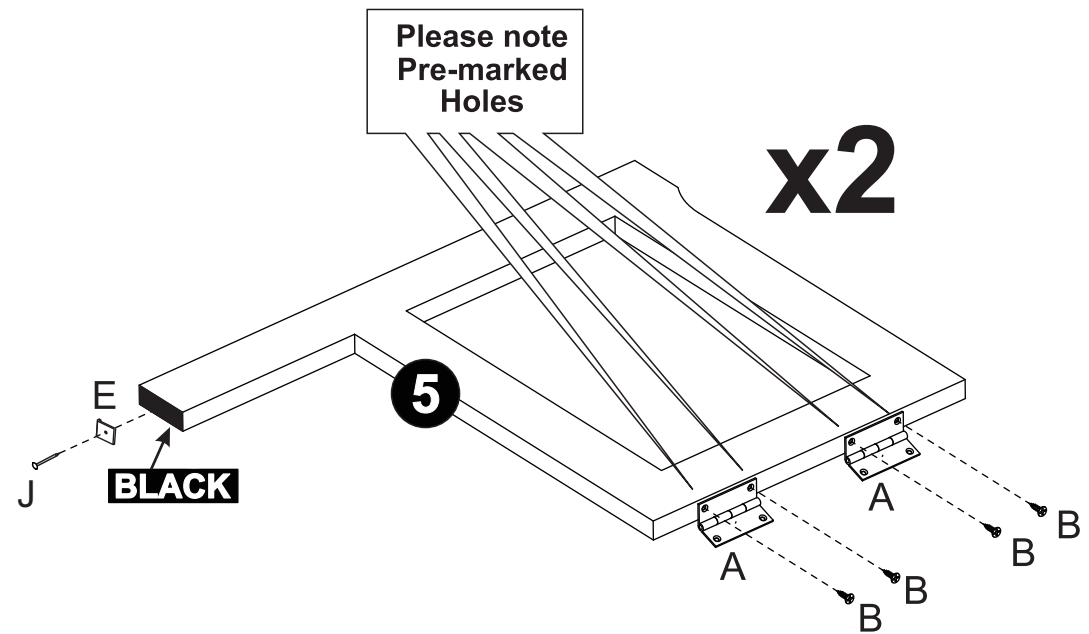
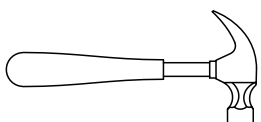
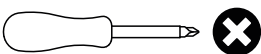

**!**  
Please assemble on a clean soft surface to avoid damage.

# STEP 9

## PARTS REQUIRED

5 - TABLE TOP SUPPORT LEG (BLACK) x1

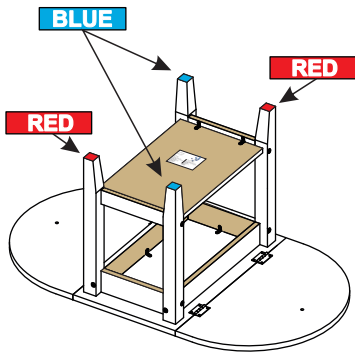

## HARDWARE REQUIRED

B  04  
Ø3,5 x 14mm

## TOOLS REQUIRED

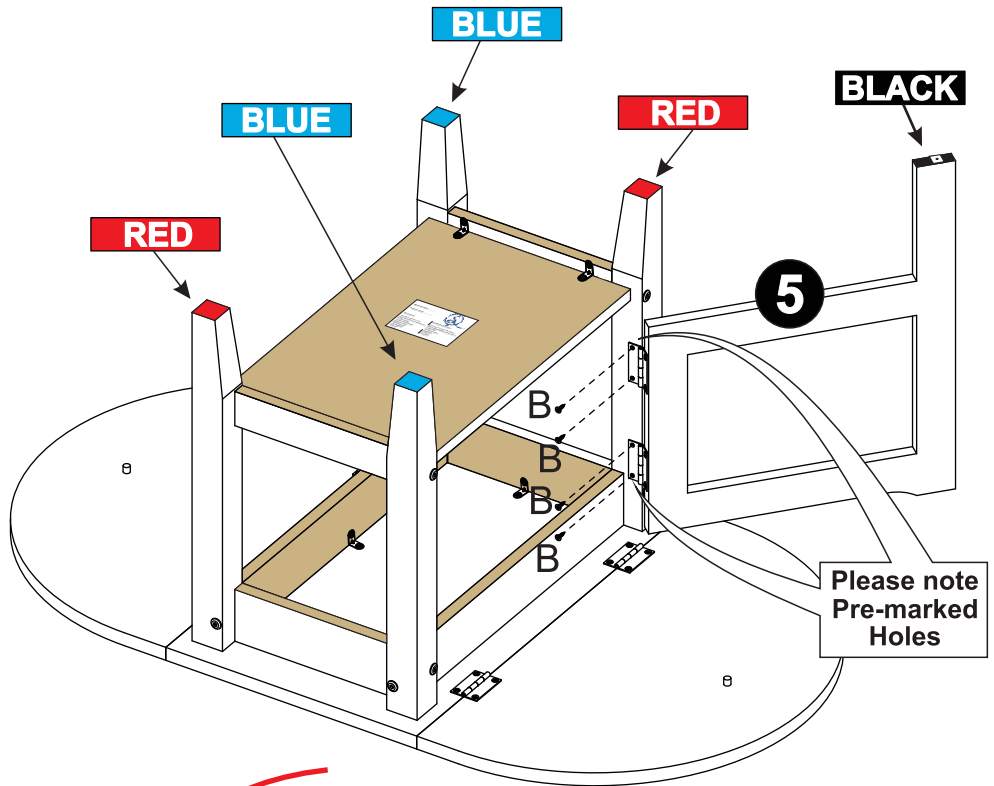
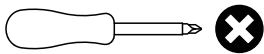

# STEP 10

## PARTS REQUIRED

5 - TABLE TOP SUPPORT LEG (BLACK) x1

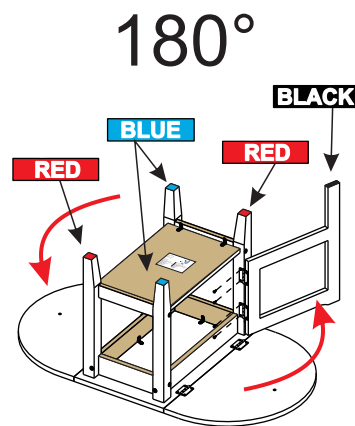

## HARDWARE REQUIRED

B  04  
Ø3,5 x 14mm

## TOOLS REQUIRED

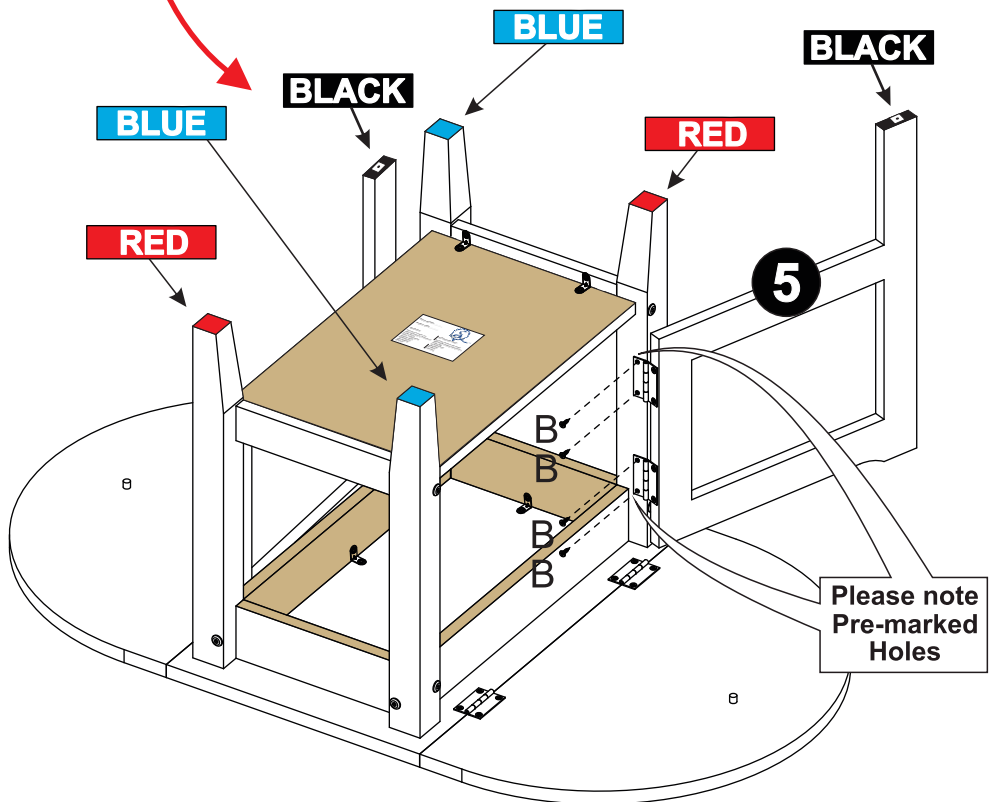
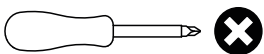



# STEP 11

PARTS REQUIRED

HARDWARE REQUIRED

TOOLS REQUIRED

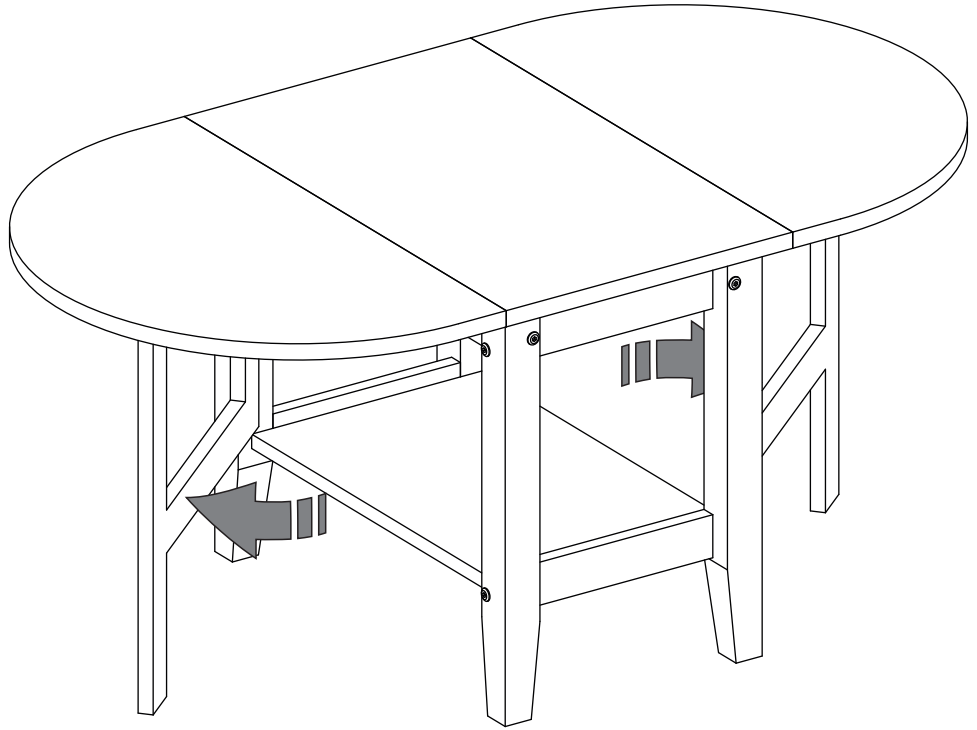

# STEP 12

PARTS REQUIRED

HARDWARE REQUIRED

TOOLS REQUIRED

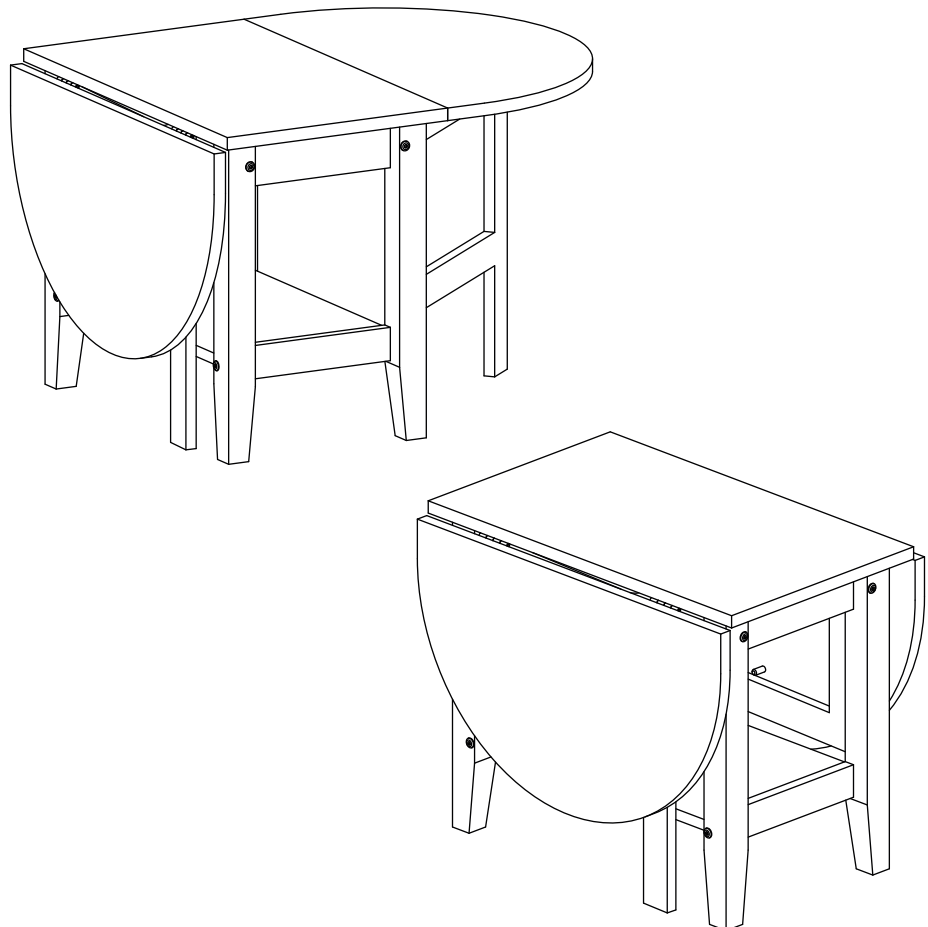

INFORMATIONS IMPORTANTES (FRENCH)	INFORMACIÓN IMPORTANTE (SPANISH)
<p style="text-align: center;"><b>IMPORTANTE POUR USAGE DOMESTIQUE UNIQUEMENT VEUILLEZ LIRE AVANT DE CONTINUER</b></p> <p>Après avoir déballé ce produit, veuillez conserver l'emballage d'origine au cas où il devrait être retourné pour une raison quelconque. Veuillez vous assurer que tous les accessoires et pièces sont présents avant de commencer l'assemblage. Nous vous recommandons de poser une couverture ou un drap sur le sol pour éviter d'endommager à la fois votre sol et les produits. Nous vous recommandons fortement de tenir les enfants éloignés de votre zone de travail. Assemblez ce produit aussi près que possible de sa position finale. Ne traînez ni ne poussez jamais les produits car cela pourrait endommager les joints et les rendre de qualité inférieure. Ne placez pas ce produit à côté d'un radiateur ou à la lumière directe du soleil. Le bois est un produit naturel et peut se dilater s'il est soumis à l'humidité et peut rétrécir ou se fissurer s'il est soumis à la chaleur. Il est donc recommandé de maintenir la température ambiante sans fluctuations brusques de température. Assurez-vous que tout déversement est immédiatement essuyé. Ne placez pas d'objets chauds ou froids directement sur la surface, utilisez un set de table sinon des marques apparaîtront. Pour le nettoyage général, utilisez un plumeau et n'utilisez aucun détergent de quelque nature que ce soit. Cependant, la surface devra être traitée de temps en temps. Cela peut être fait en utilisant de la cire en bloc (non parfumée) et en la frottant sur l'ensemble de l'objet. De temps en temps, il peut être nécessaire de resserrer les raccords, des inspections régulières doivent être effectuées.</p> <p style="text-align: center;"><b>ADVERTENCIA (ANTI-BASCULEMENT)</b></p> <p>Des blessures graves, voire mortelles, peuvent survenir en cas de basculement d'un meuble. Pour éviter que le meuble ne bascule, nous recommandons de le fixer de manière permanente au mur.</p> <p>Les fixations murales ne sont pas fournies avec ce produit, car les différents matériaux de mur nécessitent différents types de dispositifs de fixation. Veuillez vous assurer d'utiliser des fixations adaptées aux murs de votre maison. Veuillez vous référer à la dernière page.</p>	<p style="text-align: center;"><b>IMPORTANTE SOLO PARA USO DOMÉSTICO LEER ANTES DE CONTINUAR</b></p> <p>Después de desembalar este producto, conserve el embalaje original por si necesita devolverlo por cualquier motivo. Asegúrese de que todos los accesorios y piezas estén presentes antes de comenzar con el montaje. Le recomendamos que coloque una manta o sábana en el suelo para evitar dañar tanto el suelo como los productos. Le recomendamos encarecidamente que mantenga a los niños alejados de su área de trabajo. Monte este producto lo más cerca posible de su posición final. Nunca arrastre ni empuje los productos, ya que esto podría dañar las juntas y hacerlos de peor calidad. No coloque este producto junto a un radiador o bajo la luz solar directa. La madera es un producto natural y puede expandirse si se expone a la humedad y puede encogerse o agrietarse si se expone al calor. Por lo tanto, se recomienda mantener la temperatura ambiente sin fluctuaciones repentinas de temperatura. Asegúrese de limpiar cualquier derrame de inmediato. No coloque elementos calientes o fríos directamente sobre la superficie, utilice un mantel individual o se marcarán. Para la limpieza general, utilice un plumero y no utilice detergentes de ningún tipo. Sin embargo, será necesario volver a limpiar la superficie de vez en cuando. Esto se puede hacer usando cera en bloque (sin perfume) y frotándola sobre todo el artículo. De vez en cuando puede ser necesario ajustar los accesorios, se deben realizar inspecciones periódicas.</p> <p style="text-align: center;"><b>ADVERTENCIA (ANTI-VUELCO)</b></p> <p>El vuelco de los muebles puede provocar lesiones graves fatales. Para evitar que los muebles se vuelquen, recomendamos fijarlos permanentemente a la pared.</p> <p>Este producto no incluye fijaciones de pared, ya que los distintos materiales de pared requieren distintos tipos de dispositivos de fijación. Asegúrese de utilizar fijaciones adecuadas para las paredes de su hogar. Veuillez vous référer à la dernière page.</p>
<p style="text-align: center;"><b>WICHTIGE INFORMATIONEN (GERMAN)</b></p>	<p style="text-align: center;"><b>INFORMAZIONI IMPORTANTI (ITALIAN)</b></p>
<p style="text-align: center;"><b>WICHTIGUR FÜR DEN HAUSHALTSGEBRAUCH BITTE LESEN SIE, BEVOR SIE FORTFAHREN</b></p> <p>Bewahren Sie nach dem Auspacken dieses Produkts die Originalverpackung auf, falls es aus irgendeinem Grund zurückgegeben werden muss. Bitte stellen Sie sicher, dass alle Beschläge und Teile vorhanden sind, bevor Sie mit der Montage beginnen. Wir empfehlen, eine Decke oder ein Laken auf den Boden zu legen, um Schäden an Ihrem Boden und den Produkten zu vermeiden. Wir empfehlen dringend, Kinder von Ihrem Arbeitsbereich fernzuhalten. Montieren Sie dieses Produkt so nah wie möglich an seiner endgültigen Position. Ziehen oder schieben Sie Produkte niemals, da dies die Verbindungen beschädigen und sie minderwertig machen könnte. Stellen Sie dieses Produkt nicht neben einen Heizkörper oder in direktes Sonnenlicht. Holz ist ein Naturprodukt und kann sich bei Feuchtigkeit ausdehnen und bei Hitze schrumpfen oder reißen. Daher wird empfohlen, die Raumtemperatur ohne plötzliche Temperaturschwankungen aufrechtzuerhalten. Stellen Sie sicher, dass verschüttete Flüssigkeiten sofort abgewischt werden. Stellen Sie keine heißen oder gekühlten Gegenstände direkt auf die Oberfläche, verwenden Sie ein Platzdeckchen, da sonst Flecken entstehen. Verwenden Sie zur allgemeinen Reinigung einen Staubwedel und keine Reinigungsmittel jeglicher Art. Die Oberfläche muss jedoch von Zeit zu Zeit erneut behandelt werden. Dies kann durch die Verwendung von Blockwachs (unparfümiert) erreicht werden, das über den gesamten Gegenstand gerieben wird. Von Zeit zu Zeit kann es notwendig sein, Beschläge nachzuziehen, regelmäßige Kontrollen sollten durchgeführt werden.</p> <p style="text-align: center;"><b>WARNUNG (KIPPSCHUTZ)</b></p> <p>Durch das Umkippen von Möbeln können schwere oder tödliche Verletzungen entstehen. Um ein Umkippen der Möbel zu verhindern, empfehlen wir, diese dauerhaft an der Wand zu befestigen. Wandbefestigungen werden nicht mit diesem Produkt mitgeliefert, da unterschiedliche Wandmaterialien unterschiedliche Arten von Befestigungsvorrichtungen erfordern. Bitte stellen Sie sicher, dass Sie Befestigungsvorrichtungen verwenden, die für die Wände in Ihrem Zuhause geeignet sind. Bitte beachten Sie die letzte Seite.</p>	<p style="text-align: center;"><b>IMPORTANTE, SOLO PER USO DOMESTICO SI PREGA DI LEGGERE PRIMA DI CONTINUARE OLTRE</b></p> <p>Dopo aver disimballato questo prodotto, conservare l'imballaggio originale nel caso in cui sia necessario restituirlo per qualsiasi motivo. Assicurarsi che tutti i raccordi e le parti siano presenti prima di iniziare il montaggio. Si consiglia di stendere una coperta o un lenzuolo sul pavimento per evitare danni sia al pavimento che ai prodotti. Si consiglia vivamente di tenere i bambini lontani dall'area di lavoro. Montare questo prodotto il più vicino possibile alla sua posizione finale. Non trascinare o spingere mai i prodotti poiché ciò potrebbe danneggiare i giunti rendendoli di qualità inferiore. Non posizionare questo prodotto accanto a un radiatore o alla luce diretta del sole. Il legno è un prodotto naturale e può espandersi se esposto all'umidità e può restringersi o rompersi se esposto al calore. Pertanto, si consiglia di mantenere la temperatura ambiente senza improvvise fluttuazioni di temperatura. Assicurarsi che eventuali fuoriuscite vengano immediatamente pulite. Non posizionare oggetti caldi o freddi direttamente sulla superficie, utilizzare un sottopiatto o una marcatura. Per la pulizia generale, utilizzare uno spolverino e non utilizzare detergenti di alcun tipo. Tuttavia, la superficie dovrà essere ritrattata di tanto in tanto. Questo può essere fatto usando cera per blocchi (non profumata) e strofinandola su tutto l'articolo. Di tanto in tanto potrebbe essere necessario stringere i raccordi, è necessario effettuare ispezioni regolari.</p> <p style="text-align: center;"><b>AVVERTIMENTO (ANTIRIBALTAMENTO)</b></p> <p>Il ribaltamento dei mobili può provocare lesioni gravi e mortali. A evitare che i mobili si ribaltino, si consiglia di farlo fissato permanentemente al muro.</p> <p>I fissaggi a parete non sono forniti con questo prodotto in quanto parete diversa i materiali richiedono diversi tipi di dispositivi di fissaggio. Per favore, fallo assicurati di utilizzare fissaggi adatti alle pareti della tua casa. Si prega di fare riferimento all'ultima pagina.</p>