

PARIS 6 DRAWER CHEST ASSEMBLY INSTRUCTIONS

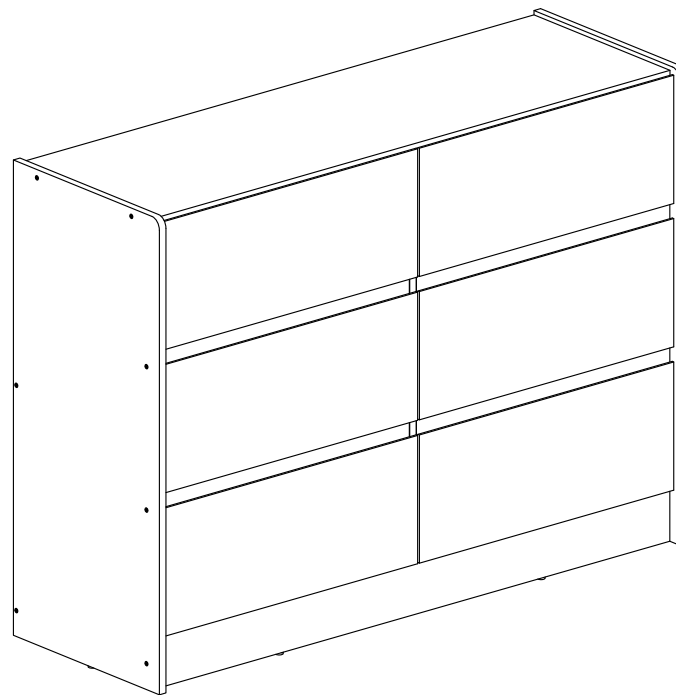

FOR DOMESTIC USE ONLY IMPORTANT

PLEASE READ BEFORE YOU CONTINUE FURTHER

THE PRODUCT YOU HAVE PURCHASED WILL GIVE YOU MANY YEARS OF SERVICE IF YOU FOLLOW THE GUIDELINES FOR ITS SAFE ASSEMBLY AND PERIODIC MAINTENANCE AND CLEANING.

ASSEMBLE ON A SOFT CLEAN SURFACE.

DO NOT USE ANY TOOLS OTHER THAN THOSE SHOWN.

ANY SPANNERS OR ALLEN KEYS REQUIRED ARE INCLUDED WITH THE FITTING KIT.

DO NOT FOR ANY REASON USE A POWER TOOL TO ASSEMBLE THIS PRODUCT. ITS USE WILL INVALIDATE ANY CLAIM YOU MAY HAVE AND COULD MAKE THIS PRODUCT UNSAFE.

DEPENDING ON THE AMOUNT OF USE THIS PRODUCT RECEIVES, IT MAY BE NECESSARY TO TIGHTEN UP THE FIXINGS FROM TIME TO TIME. THIS IS COMPLETELY NORMAL FOR ANY FLAT PACK FURNITURE . DO NOT OVERTIGHTEN FIXINGS.

FOR CLEANING, YOU MAY USE A DAMP CLOTH (NOT WET).
DO NOT USE POLISH, DETERGENT OR CHEMICAL CLEANERS.

THIS SURFACE OF THIS ITEM IS NOT HEAT RESISTANT. ALWAYS USE A PLACE MAT UNDER HOT OR COLD ITEMS TO PREVENT MARKING.

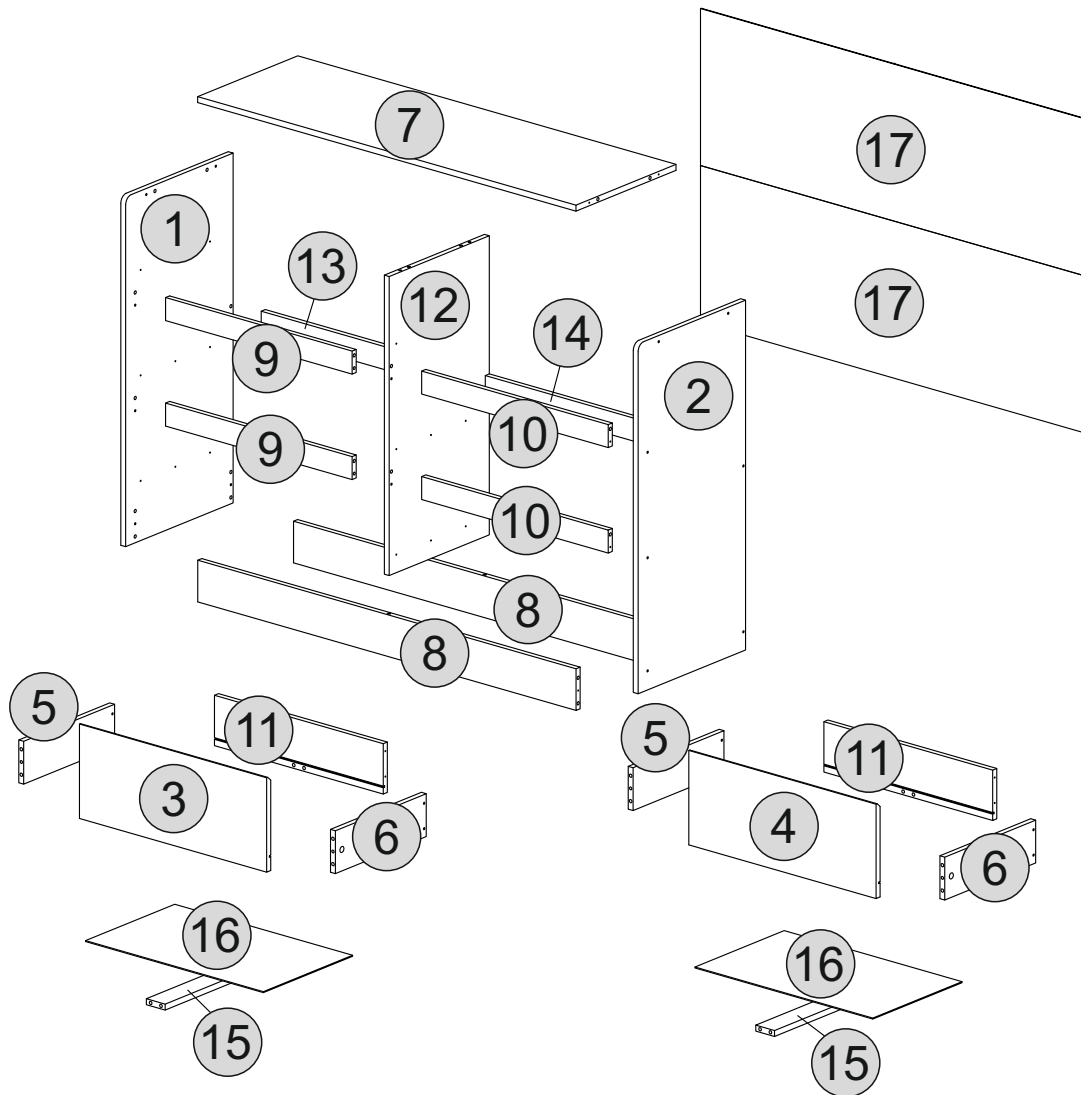

PART LIST

Part Number	Part Code	Part Description	Quantity	Carton
1	S100-102-194-FM1-01	Side Panel (Left)	1	2/2
2	S100-102-194-FM1-02	Side Panel (Right)	1	2/2
3	S100-102-194-FM1-03	Drawer Front Panel (Left)	3	1/2
4	S100-102-194-FM1-04	Drawer Front Panel (Right)	3	1/2
5	S100-102-194-FM1-05	Drawer Side Panel (Left)	6	2/2
6	S100-102-194-FM1-06	Drawer Side Panel (Right)	6	2/2
7	S100-102-194-FM1-07	Top Panel	1	1/2
8	S100-102-194-FM1-08	Bottom Crossbar	2	1/2
9	S100-102-194-FM1-09	Crossbar Panel (Left)	2	1/2
10	S100-102-194-FM1-10	Crossbar Panel (Right)	2	1/2
11	S100-102-194-FM1-11	Drawer Backboard	6	1/2
12	S100-102-194-FM1-12	Centre Panel	1	2/2
13	S100-102-194-FM1-13	Back Crossbar (Left)	1	1/2
14	S100-102-194-FM1-14	Back Crossbar (Right)	1	1/2
15	S100-102-194-FM1-15	Drawer Crossbar	6	2/2
16	S100-102-194-FM1-16	Drawer Bottom Panel	6	1/2
17	S100-102-194-FM1-17	Backboard	2	1/2

HARDWARE LIST

No.	Part Name		Qty	Carton
A	Wooden Dowel 8 x 25mm		x76	1/2
B	Plastic Foot		x6	1/2
C	Nail		x66	1/2
D	Mini Fix 15mm		x20 Sets	1/2
E	Single Plastic Cap		x24	1/2
F	Screw M3.5 x 14mm		x108	1/2
G	Screw M4 x 38mm		x24	1/2
H	FH Screw M5 x 40mm		x14	1/2
I	Drawer Metal Slide 350mm		x6 Sets	1/2
J	Wall Fittings		x2	1/2

TIPS FOR FITTINGS CAM-LOCKS

WHEN FITTING CAM NUT. ENSURE STARTING POSITION IS CORRECT BEFORE YOU INSERT CONNECTING CAM BOLT TURN CLOCKWISE UNTIL SECURE



↑

CORRECT



WRONG

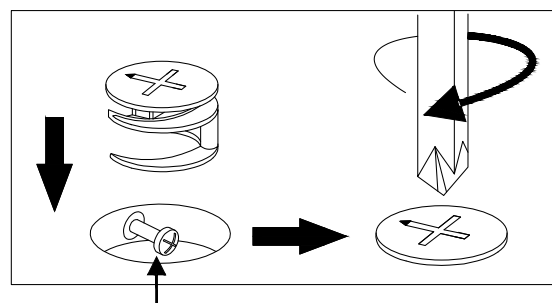

Cam bolt head needs to be in centre

CAMBOLT

Tighten until shoulder in flush with panel. Do not overtighten or undertighten (see example below)

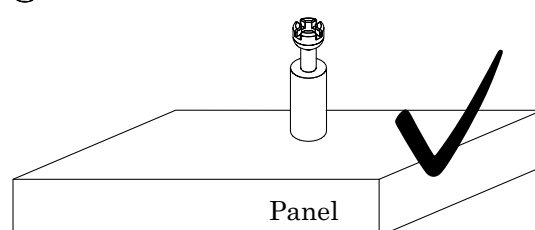
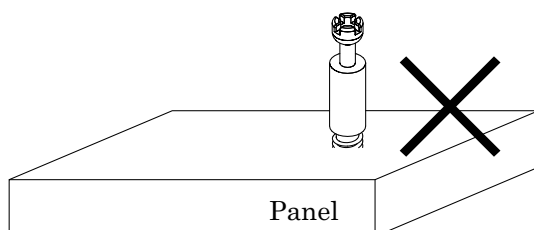
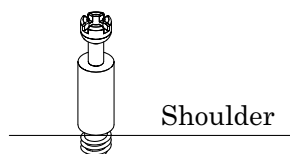



STEP 1

PARTS REQUIRED

7 - TOP PANEL	x1
8 - BOTTOM CROSSBAR	x2

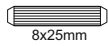
HARDWARE REQUIRED

A		12
D		02

TOOLS REQUIRED

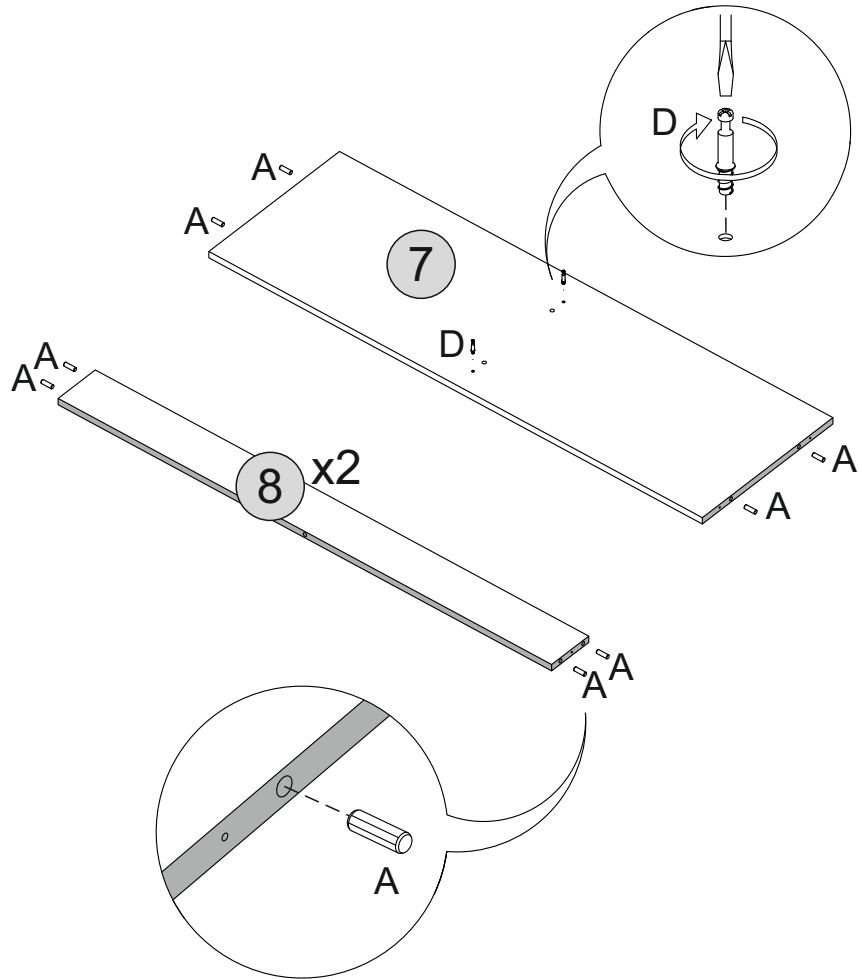
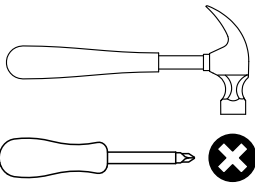



STEP 2

PARTS REQUIRED

9 - CROSSBAR PANEL (LEFT)	x2
10- CROSSBAR PANEL (RIGHT)	x2
13- BACK CROSSBAR (LEFT)	x1
14- BACK CROSSBAR (RIGHT)	x1

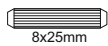
HARDWARE REQUIRED

A		12
D		06

TOOLS REQUIRED

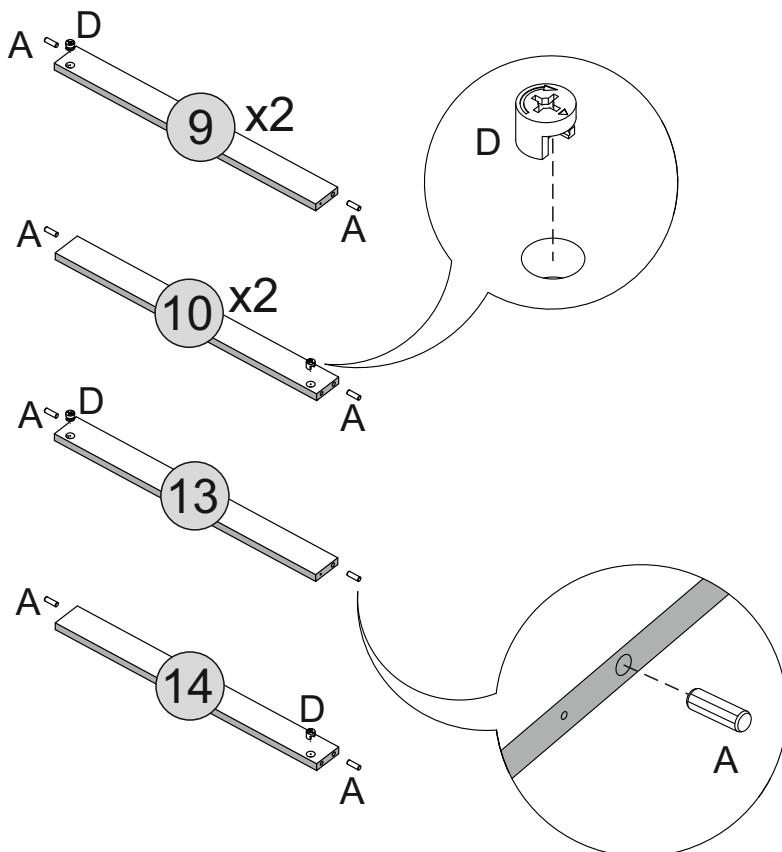
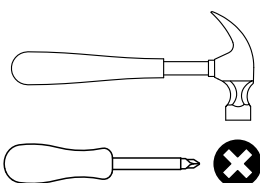

STEP 3

PARTS REQUIRED

1 - SIDE PANEL (LEFT) x1

2 - SIDE PANEL (RIGHT) x1

HARDWARE REQUIRED

F  18

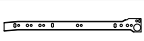
I  06

TOOLS REQUIRED

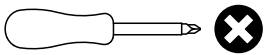

To Assemble the Drawer Slide, Please Follow Step as Below

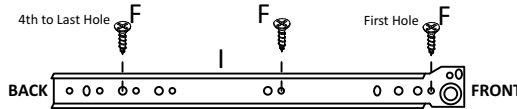

To Assemble the Drawer Slide, Please Follow Step as Below

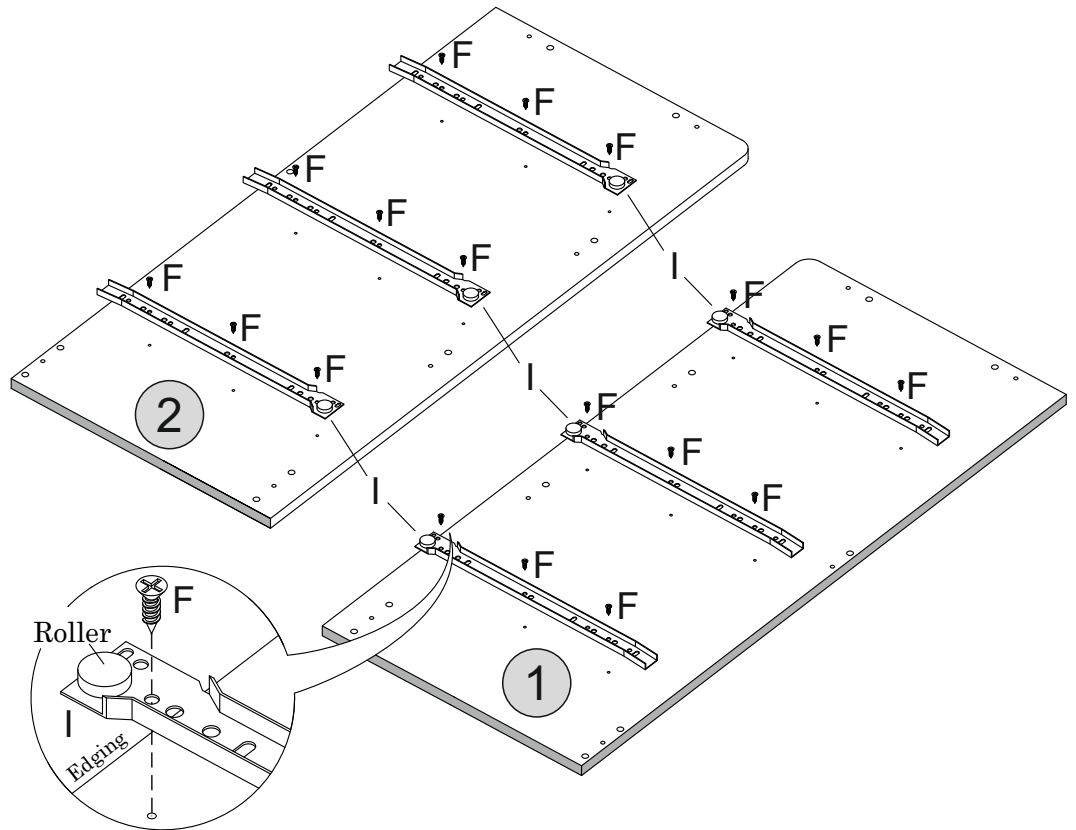
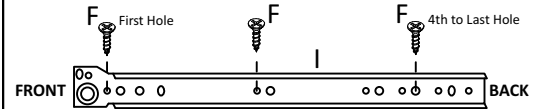

STEP 4

PARTS REQUIRED

12- CENTRE PANEL x1

HARDWARE REQUIRED

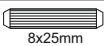
A  8x25mm 04

D  02

D  06

F  18

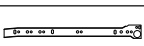
I  06

TOOLS REQUIRED

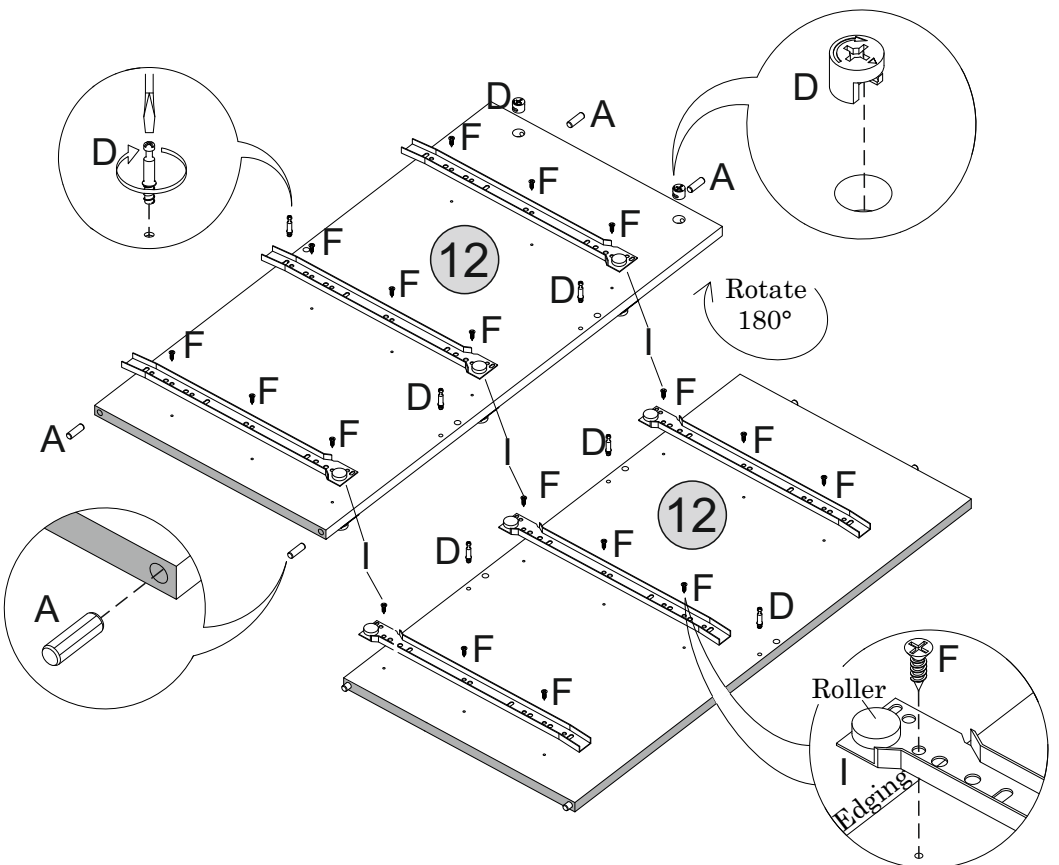
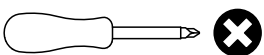
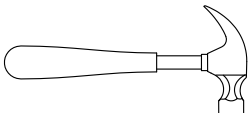

To Assemble the Drawer Slide, Please Follow Step as Below

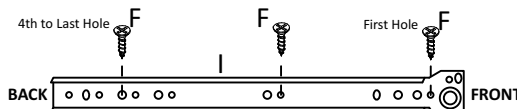

To Assemble the Drawer Slide, Please Follow Step as Below

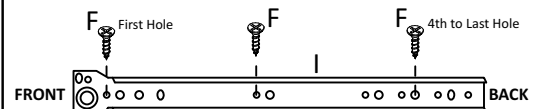

STEP 5

PARTS REQUIRED

7 - TOP PANEL x1

12- CENTRE PANEL x1

HARDWARE REQUIRED

TOOLS REQUIRED

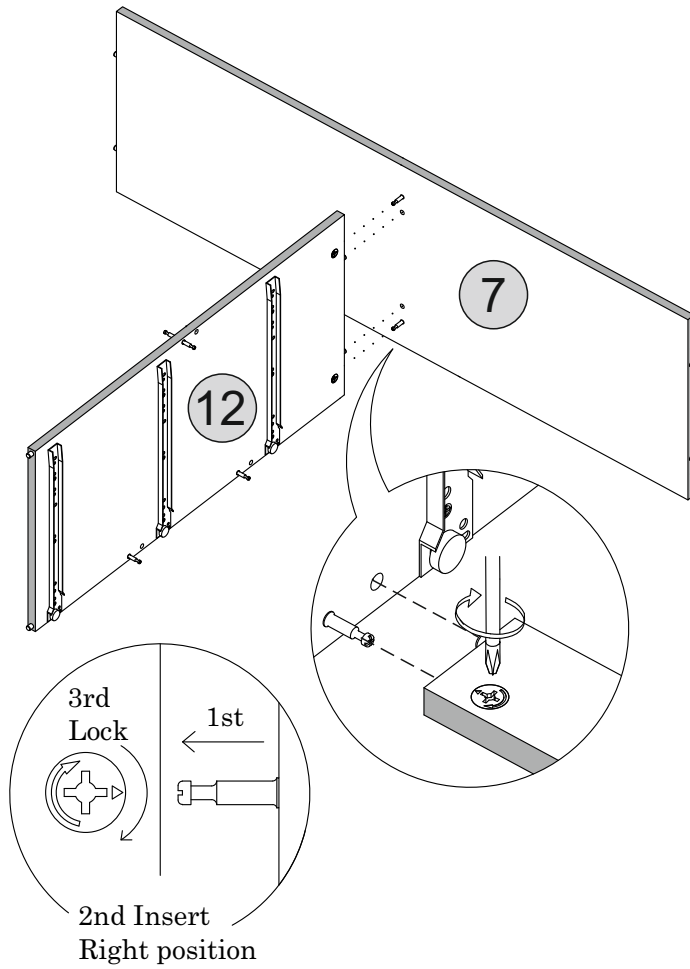
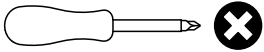

STEP 6

PARTS REQUIRED

9 - CROSSBAR PANEL (LEFT) x2

10- CROSSBAR PANEL (RIGHT) x2

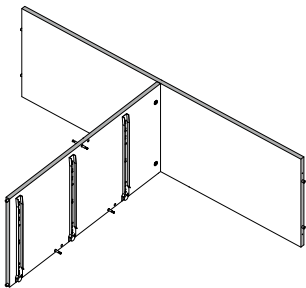

HARDWARE REQUIRED

TOOLS REQUIRED

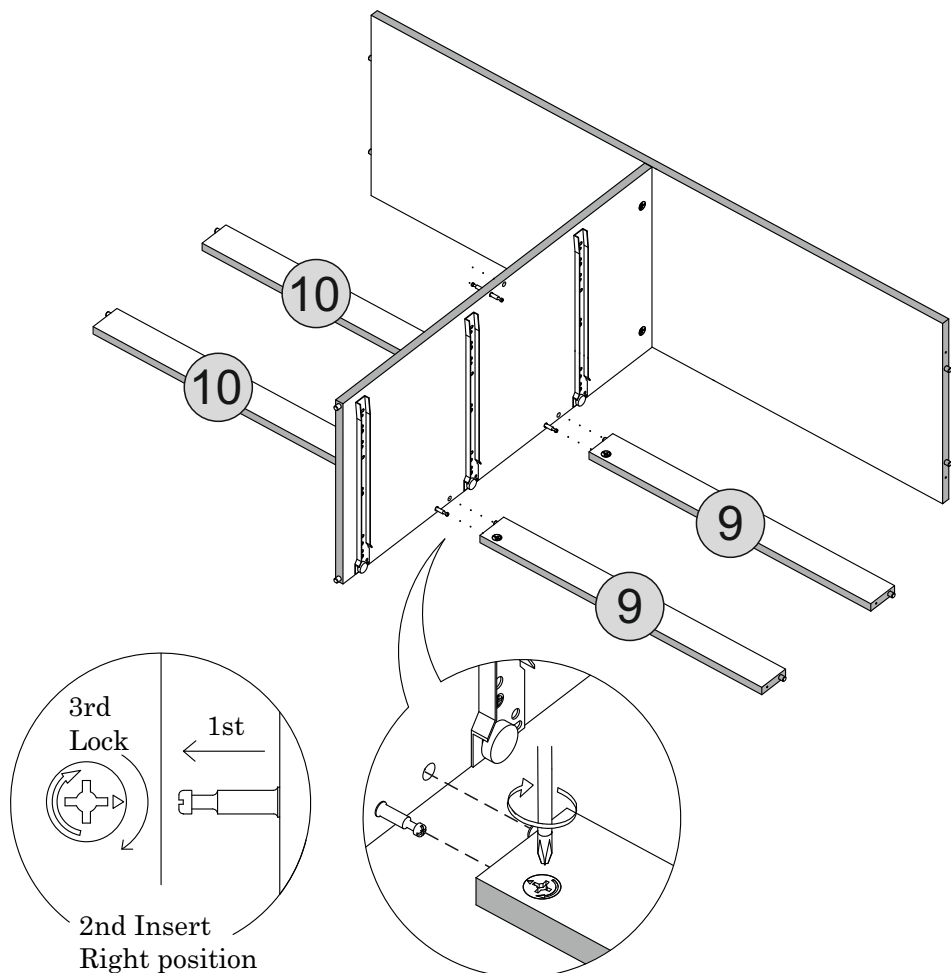
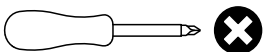

STEP 7

PARTS REQUIRED

1 - SIDE PANEL (LEFT) x1

8 - BOTTOM CROSSBAR x2

13- BACK CROSSBAR (LEFT) x1

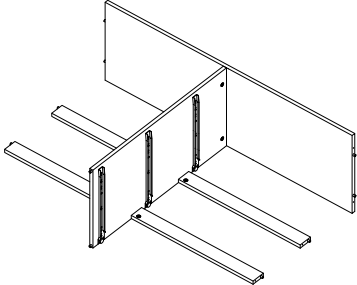

HARDWARE REQUIRED

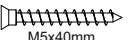
H  07
M5x40mm

TOOLS REQUIRED

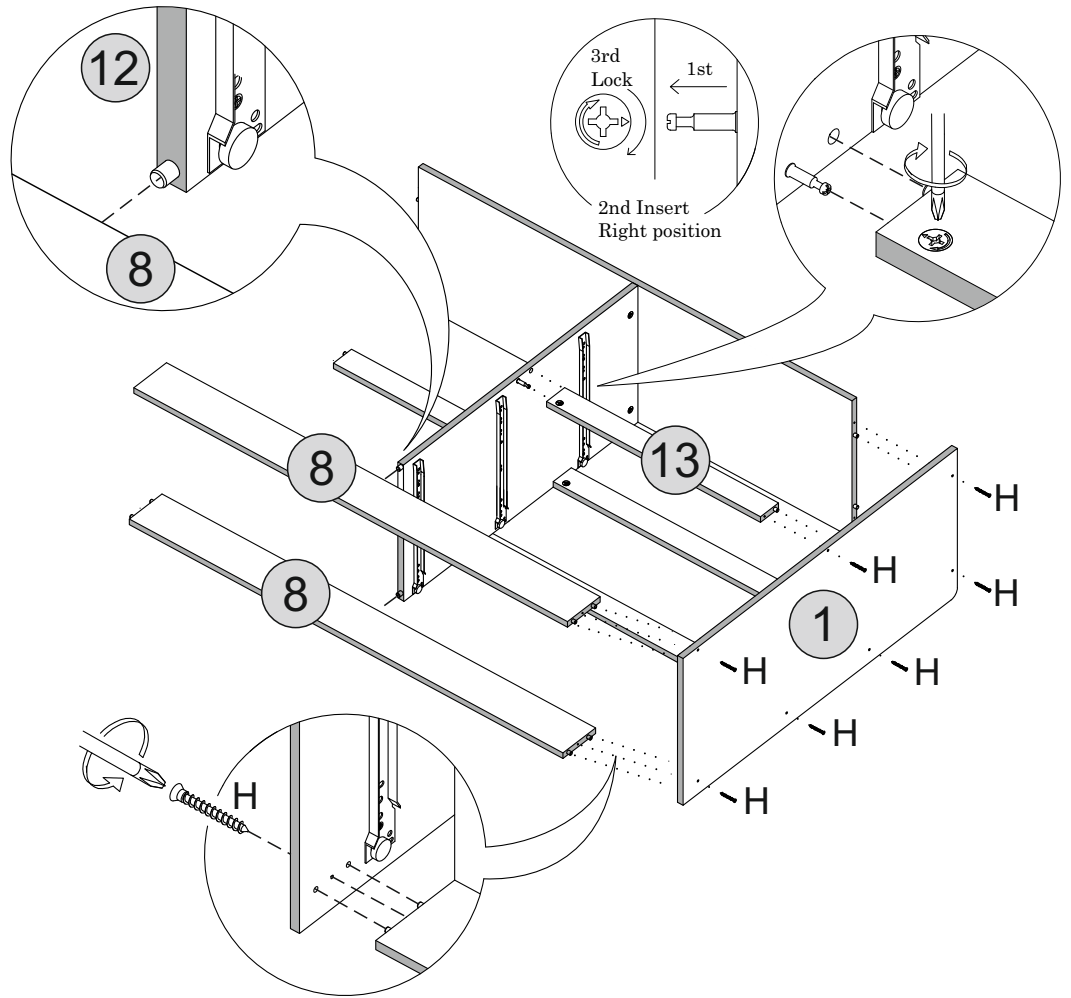
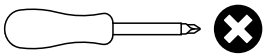

STEP 8

PARTS REQUIRED

2 - SIDE PANEL (RIGHT) x1

14- BACK CROSSBAR (RIGHT) x1

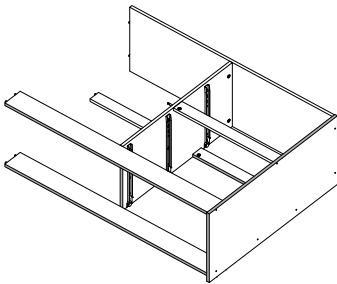

HARDWARE REQUIRED

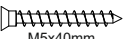
H  07
M5x40mm

TOOLS REQUIRED

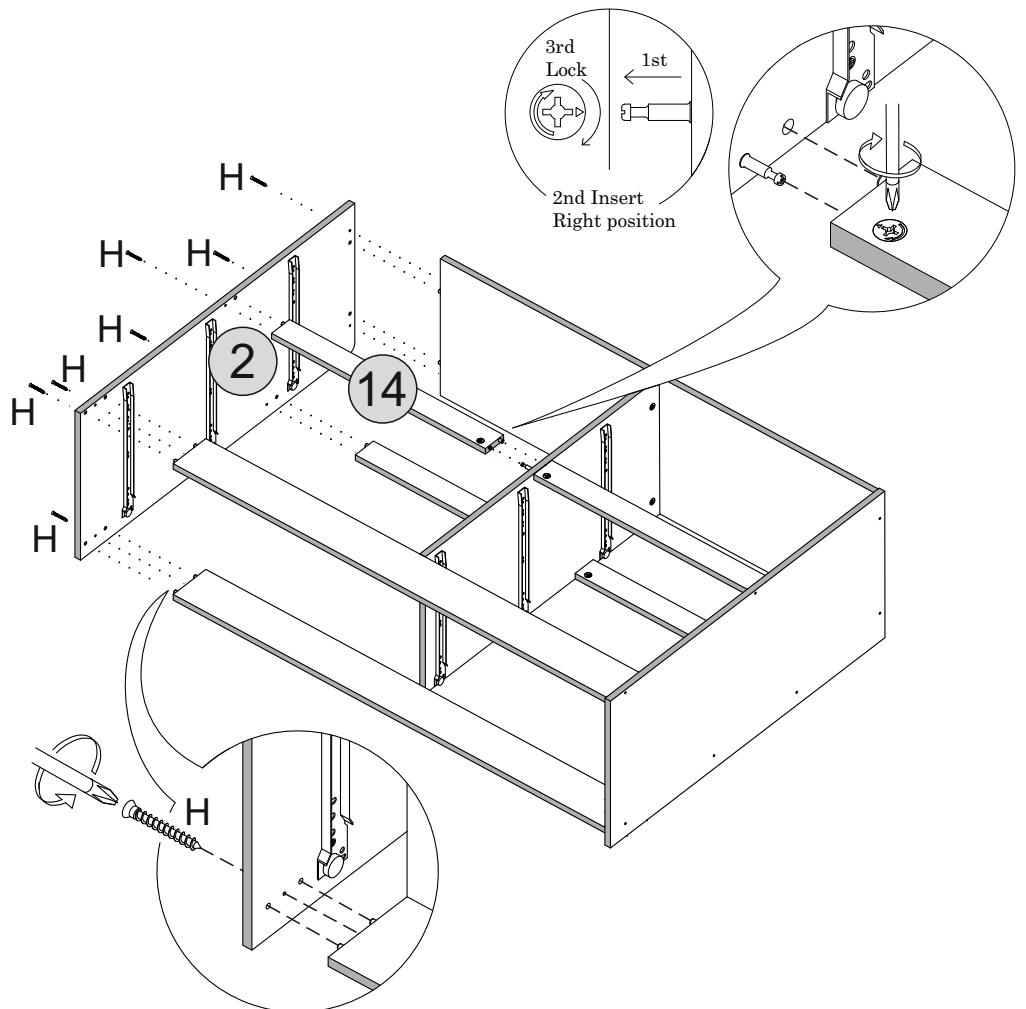
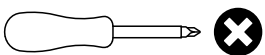

STEP 9

PARTS REQUIRED

17- BACKBOARD x2

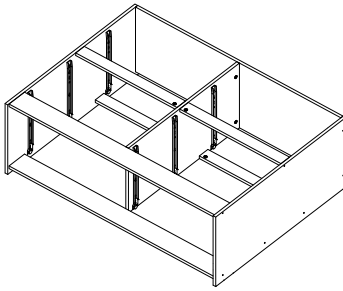

HARDWARE REQUIRED

B  06

C  30

F  12

TOOLS REQUIRED

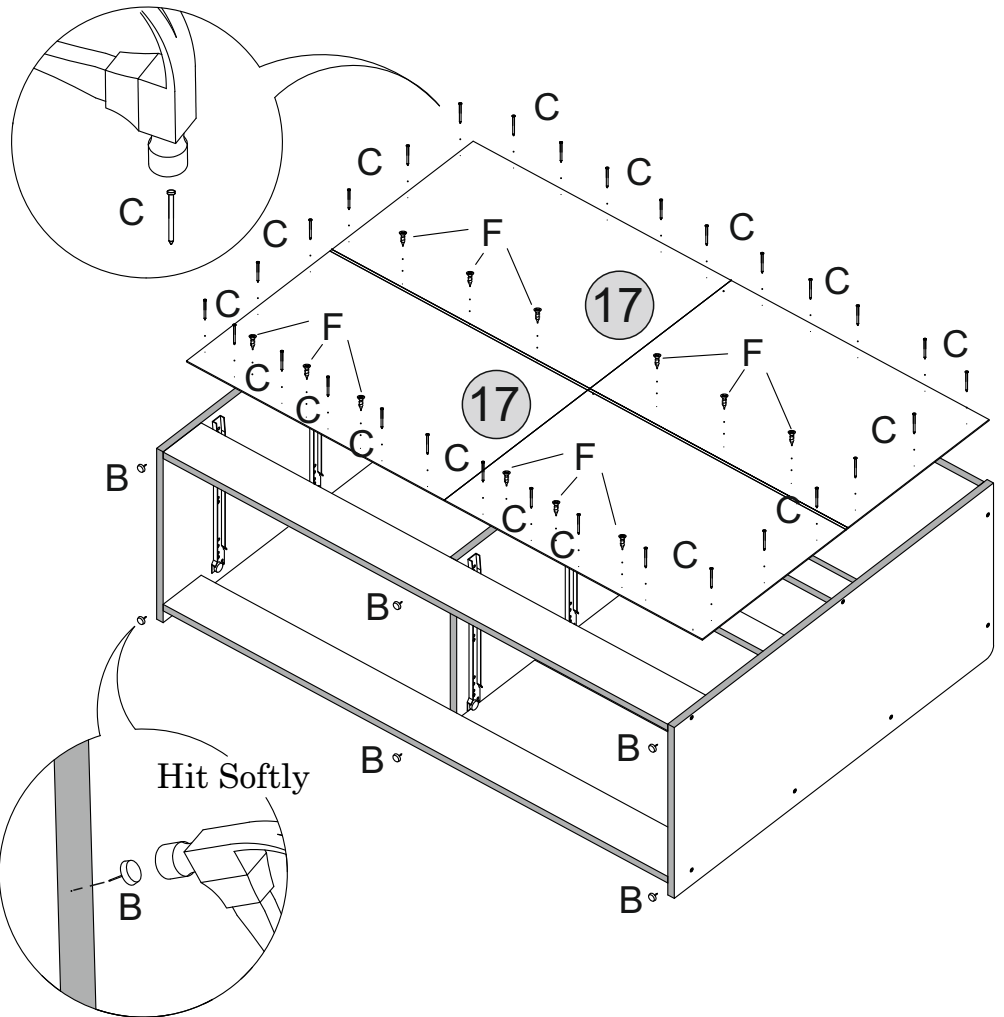
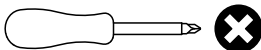
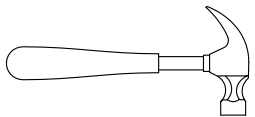

STEP 10

PARTS REQUIRED

3 - DRAWER FRONT (LEFT) x3

4 - DRAWER FRONT (RIGHT) x3

5 - DRAWER SIDE (LEFT) x6

6 - DRAWER SIDE (RIGHT) x6

15- DRAWER CROSSBAR x6

HARDWARE REQUIRED

A  8x25mm 48

D  12

D  12

TOOLS REQUIRED

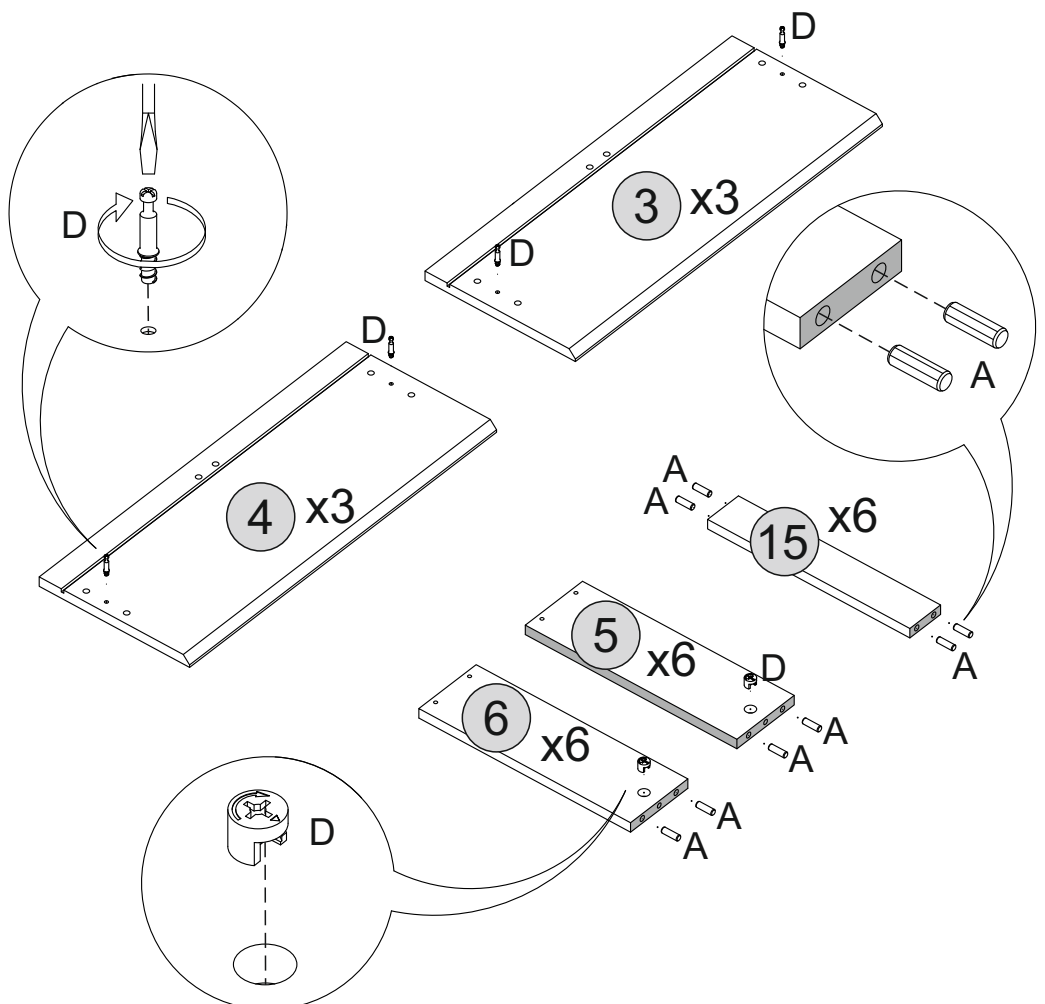

STEP 11

PARTS REQUIRED

5 - DRAWER FRONT (LEFT) x6

6 - DRAWER FRONT (RIGHT) x6

11- DRAWER BACKBOARD x6

HARDWARE REQUIRED

G  24
M4x38mm

TOOLS REQUIRED

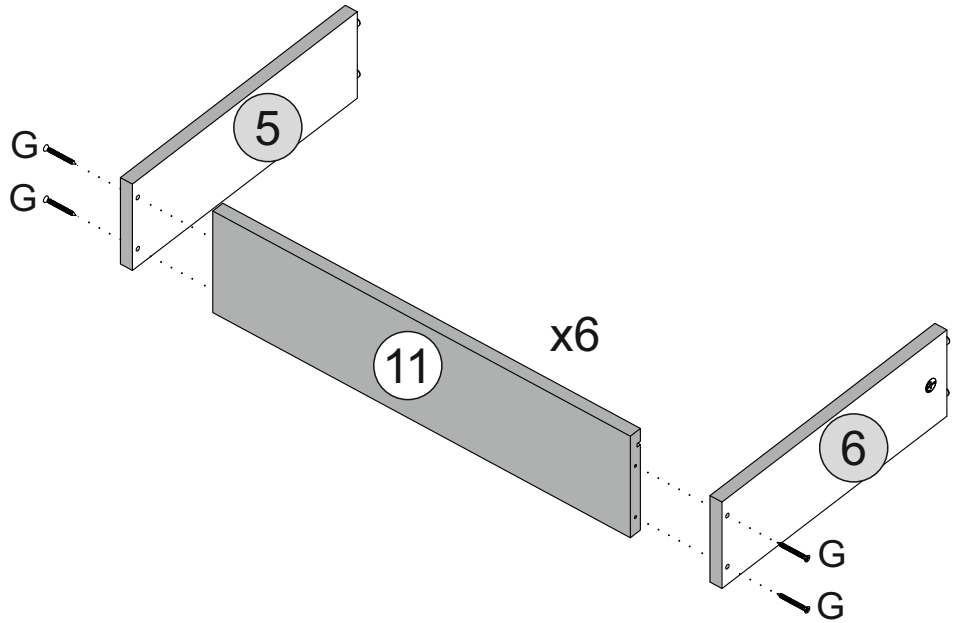
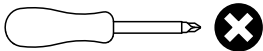

STEP 12

PARTS REQUIRED

3 - DRAWER FRONT (LEFT) x3

4 - DRAWER FRONT (RIGHT) x3

15- DRAWER CROSSBAR x6

16- DRAWER BOTTOM PANEL x6

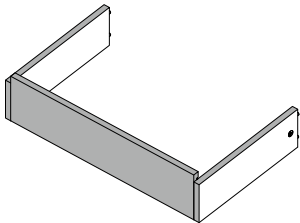

HARDWARE REQUIRED

C  36

TOOLS REQUIRED

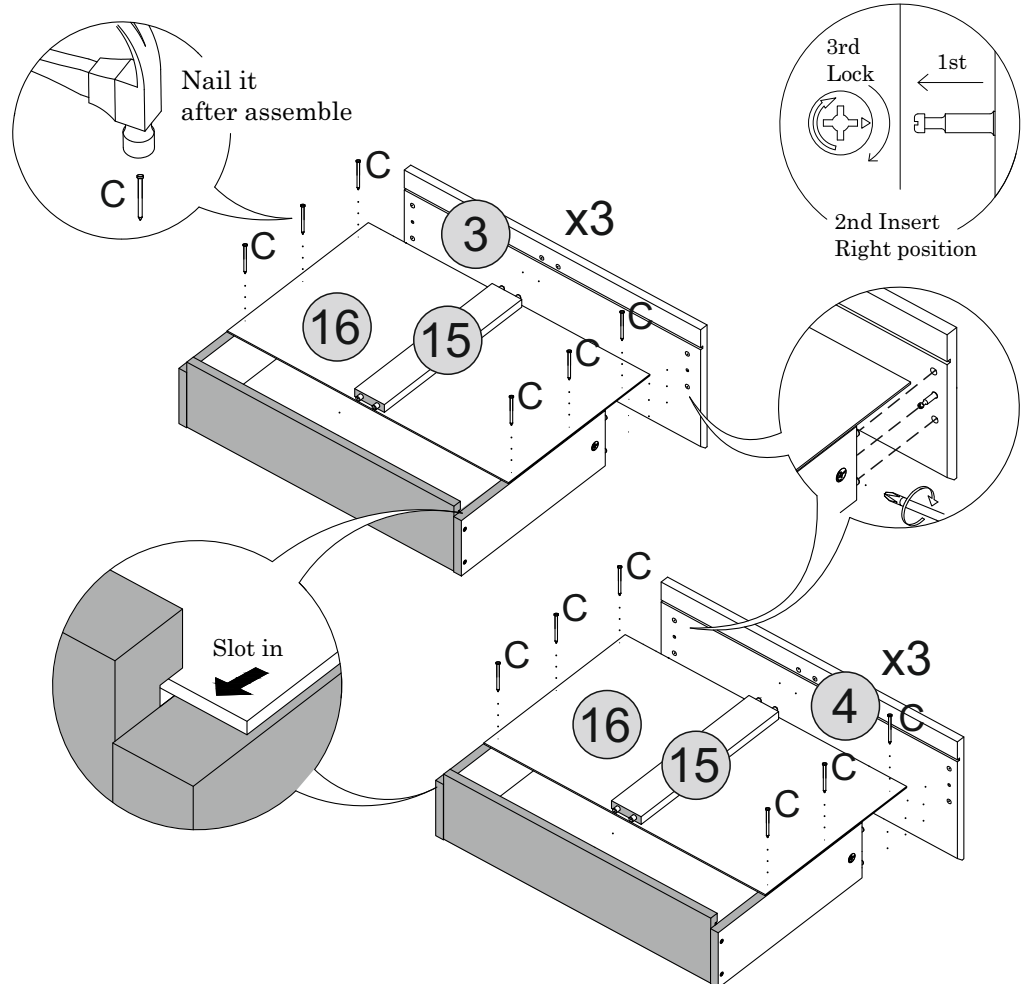
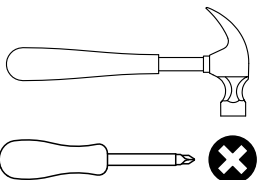

STEP 13

PARTS REQUIRED

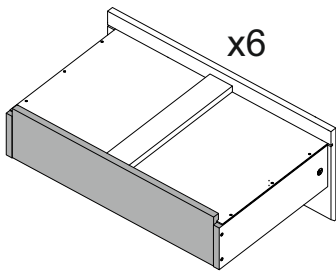

HARDWARE REQUIRED

E		24
F		60
I		06

TOOLS REQUIRED

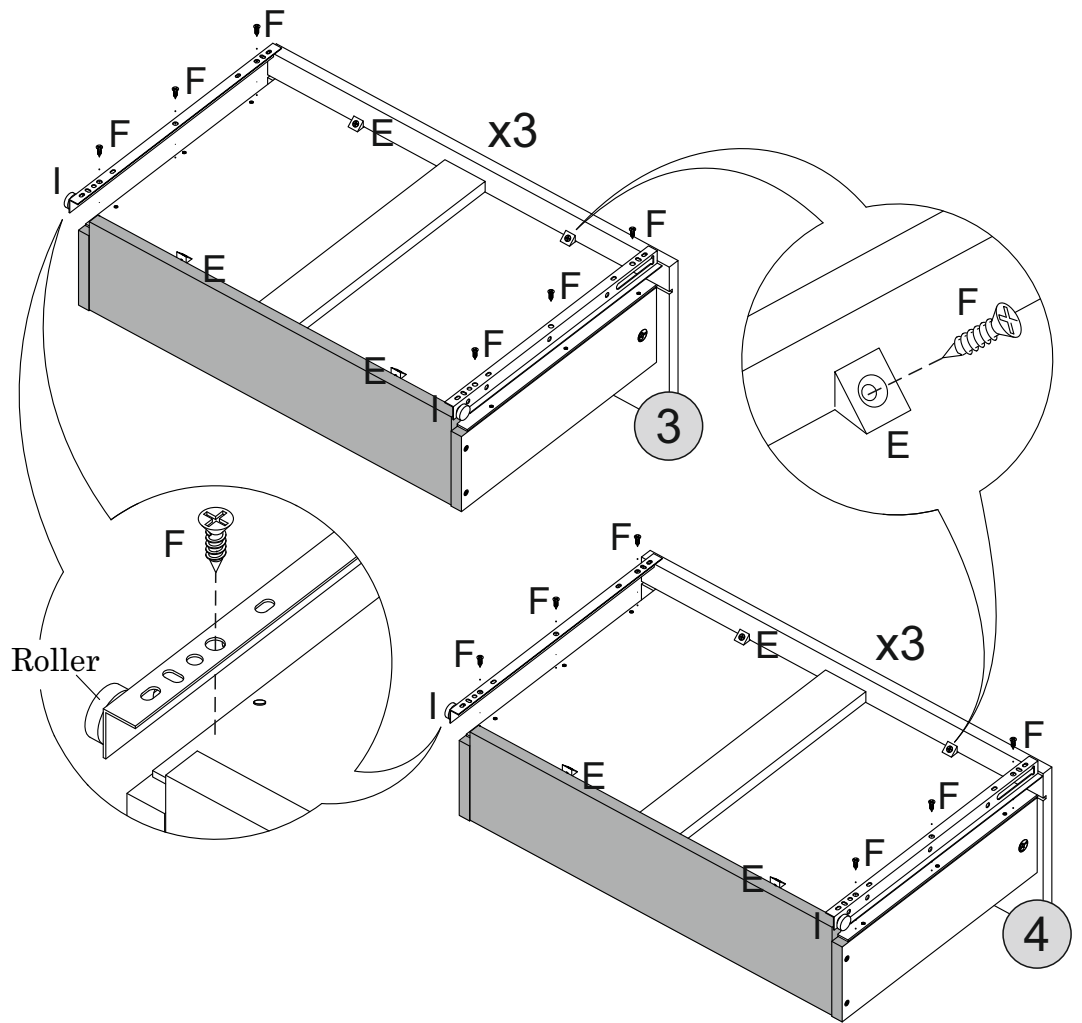
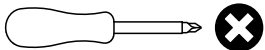

STEP 14

PARTS REQUIRED

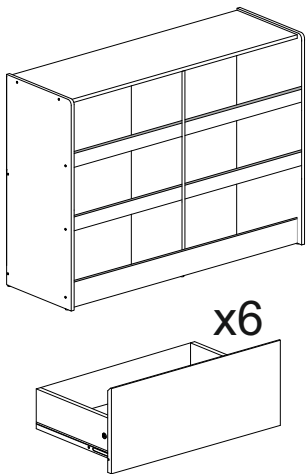

HARDWARE REQUIRED

J		02
---	--	----

TOOLS REQUIRED

