

# MALVERN 1 DOOR WARDROBE ASSEMBLY INSTRUCTIONS

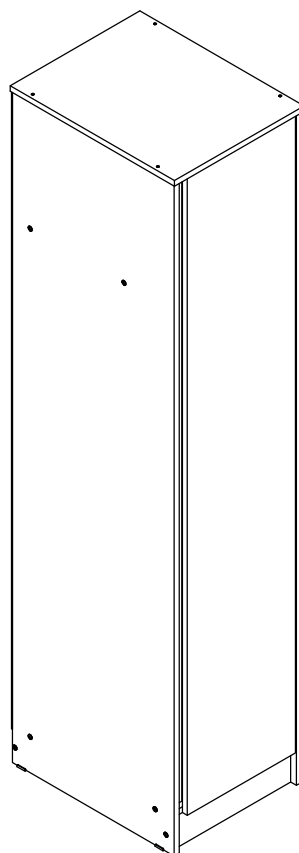
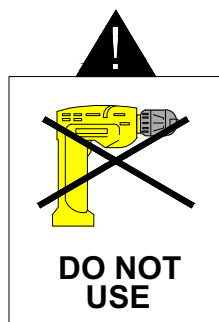

## **IMPORTANT FOR DOMESTIC USE ONLY PLEASE READ BEFORE YOU CONTINUE FURTHER**

THE PRODUCT YOU HAVE PURCHASED WILL GIVE YOU MANY YEARS OF SERVICE IF YOU FOLLOW THE GUIDELINES FOR ITS SAFE ASSEMBLY AND PERIODIC MAINTENANCE AND CLEANING.

ASSEMBLE ON A SOFT CLEAN SURFACE.

DO NOT USE ANY TOOLS OTHER THAN THOSE SHOWN.

ANY SPANNERS OR ALLEN KEYS REQUIRED ARE INCLUDED WITH THE FITTINGS KIT.

DO NOT FOR ANY REASON USE A POWER TOOL TO ASSEMBLE THIS PRODUCT. ITS USE WILL INVALIDATE ANY CLAIM YOU MAY HAVE AND COULD MAKE THIS PRODUCT UNSAFE.

DEPENDING ON THE AMOUNT OF USE THIS PRODUCT RECEIVES IT MAY BE NECESSARY TO TIGHTEN UP THE FIXINGS FROM TIME TO TIME. THIS IS COMPLETELY NORMAL FOR ANY FLAT PACK FURNITURE. DO NOT OVERTIGHTEN FIXING.

FOR CLEANING, YOU MAY USE A DAMP CLOTH (NOT WET) DO NOT USE POLISH, DETERGENT OR CHEMICAL CLEANERS.



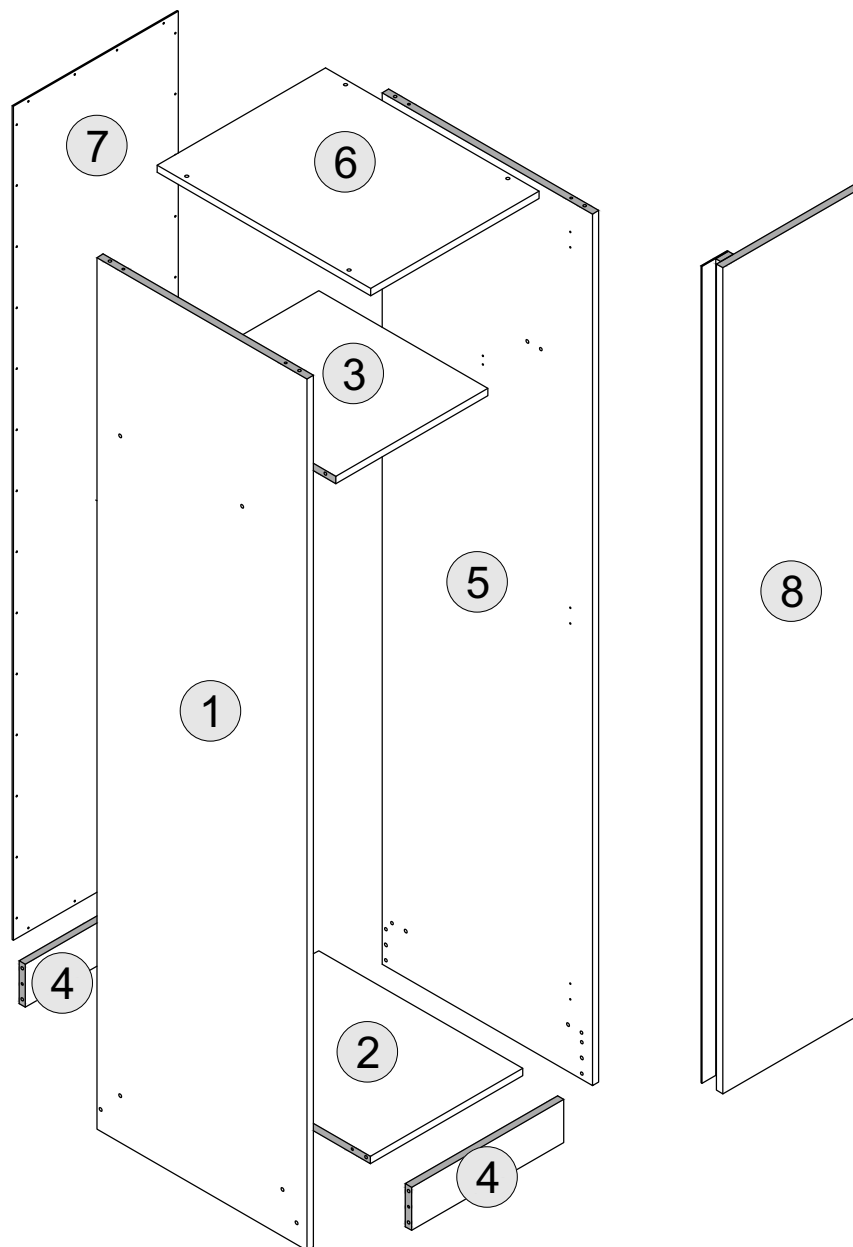





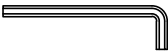
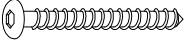
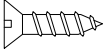
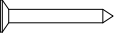

THE SURFACE OF THIS ITEM IS NOT HEAT RESISTANT. ALWAYS USE A PLACE MAT UNDER HOT OR COLD ITEMS TO PREVENT MARKING.

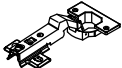

## PART LIST

<u>Part Number</u>	<u>Part Code</u>	<u>Part Description</u>	<u>Quantity</u>	<u>Carton</u>
1	S100-101-212-EU1-01	Side Panel - Left	1	1/2
2	S100-101-212-EU1-02	Bottom Panel	1	2/2
3	S100-101-212-EU1-03	Shelf Panel	1	2/2
4	S100-101-212-EU1-04	Base Apron	2	2/2
5	S100-101-212-EU1-05	Side Panel - Right	1	1/2
6	S100-101-212-EU1-06	Top Panel	1	2/2
7	S100-101-212-EU1-07	Back Panel	1	1/2
8	S100-101-212-EU1-08	Door	1	2/2

## HARDWARE LIST

A		DOWEL 6 X 30MM	20 PCS
B		ALLEN KEY	1 PC
C		BOLT M6 X 50MM	12 PCS
D		SCREW M3.5 X 16MM	11 PCS
E		TACK	40 PCS
F		PLASTIC FOOT	4 PCS
G		SCREW M3.5 X 12MM	4 PCS
H		TAPPING SCREW M8 X 12MM	6 PCS
I		HANGING RAIL SUPPORT	2 PCS
J		HANGING RAIL	1 PC
K		SCREW M6 X 50MM	4 PCS
L		HINGES 7/8	3 PCS
M		PVC STOPPER	1 PC
N		ANTI - TIP STRAP	2 PCS
O		SCREW M4 X 16MM	2 PCS

# STEP 1

PARTS REQUIRED

1 - SIDE PANEL - LEFT x1

HARDWARE REQUIRED

A  02

G  02

I  01

TOOLS REQUIRED

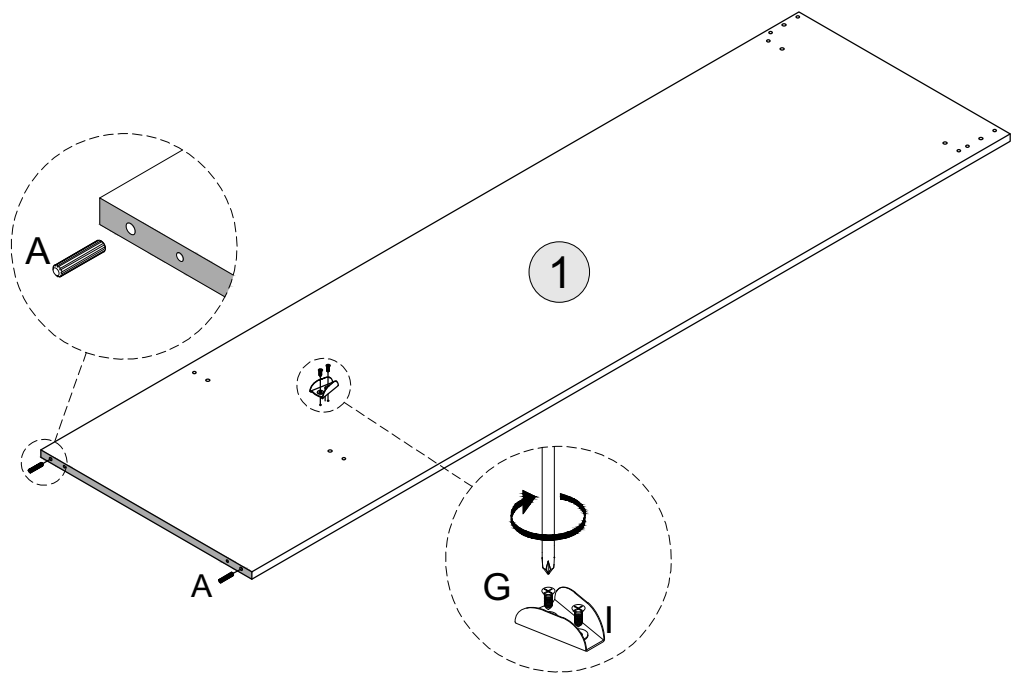
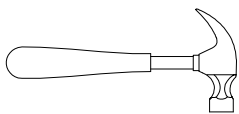
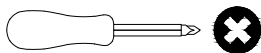

# STEP 2

PARTS REQUIRED

2 - BOTTOM PANEL x1

3 - SHELF PANEL x1

4 - BASE APRON x2

HARDWARE REQUIRED

A  16

TOOLS REQUIRED

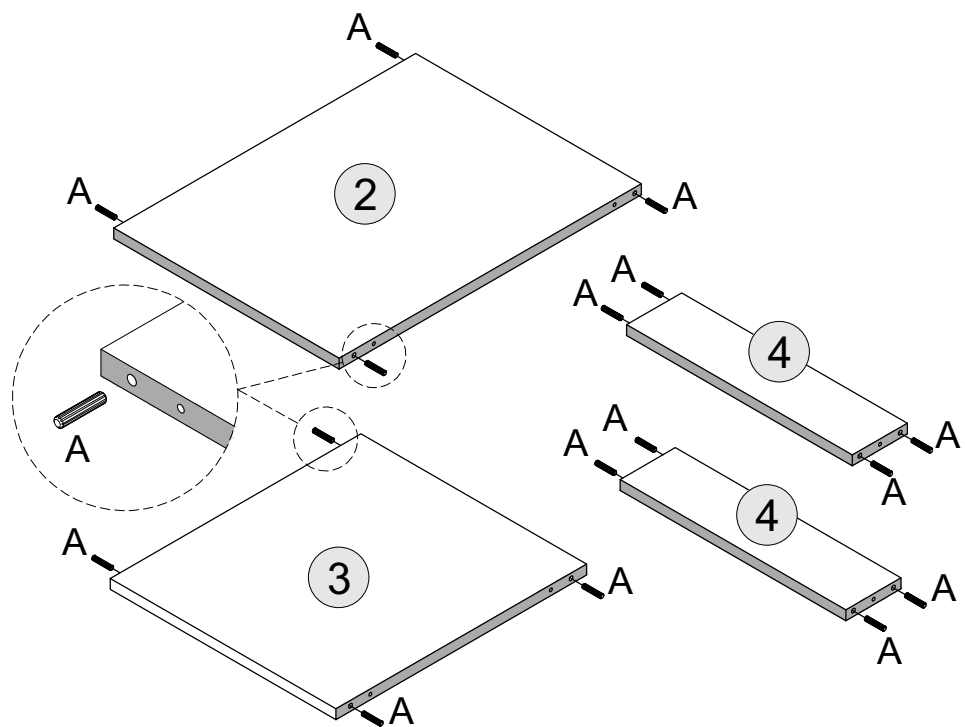
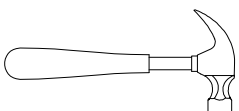

## STEP 3

### PARTS REQUIRED

5 - SIDE PANEL - RIGHT x1

### HARDWARE REQUIRED

A  02

G  02

I  01

### TOOLS REQUIRED

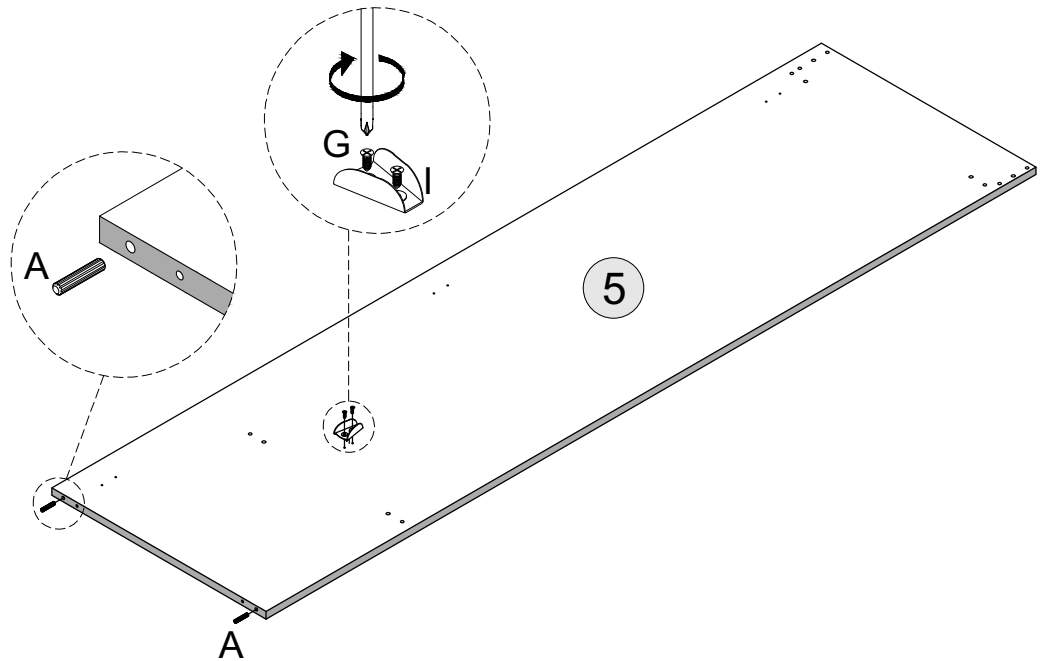
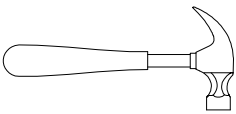
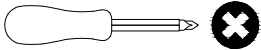

## STEP 4

### PARTS REQUIRED

6 - TOP PANEL x1

### HARDWARE REQUIRED

D  01

M  01

### TOOLS REQUIRED

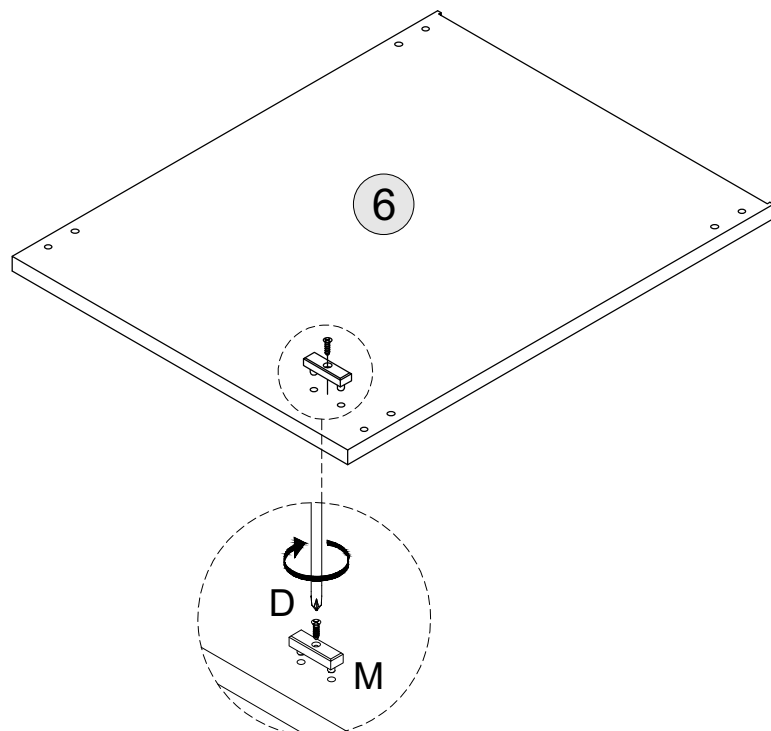
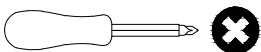

# STEP 5

PARTS REQUIRED

1 - SIDE PANEL - LEFT	x1
2 - BOTTOM PANEL	x1
3 - SHELF PANEL	x1
4 - BASE APRON	x2

HARDWARE REQUIRED



TOOLS REQUIRED

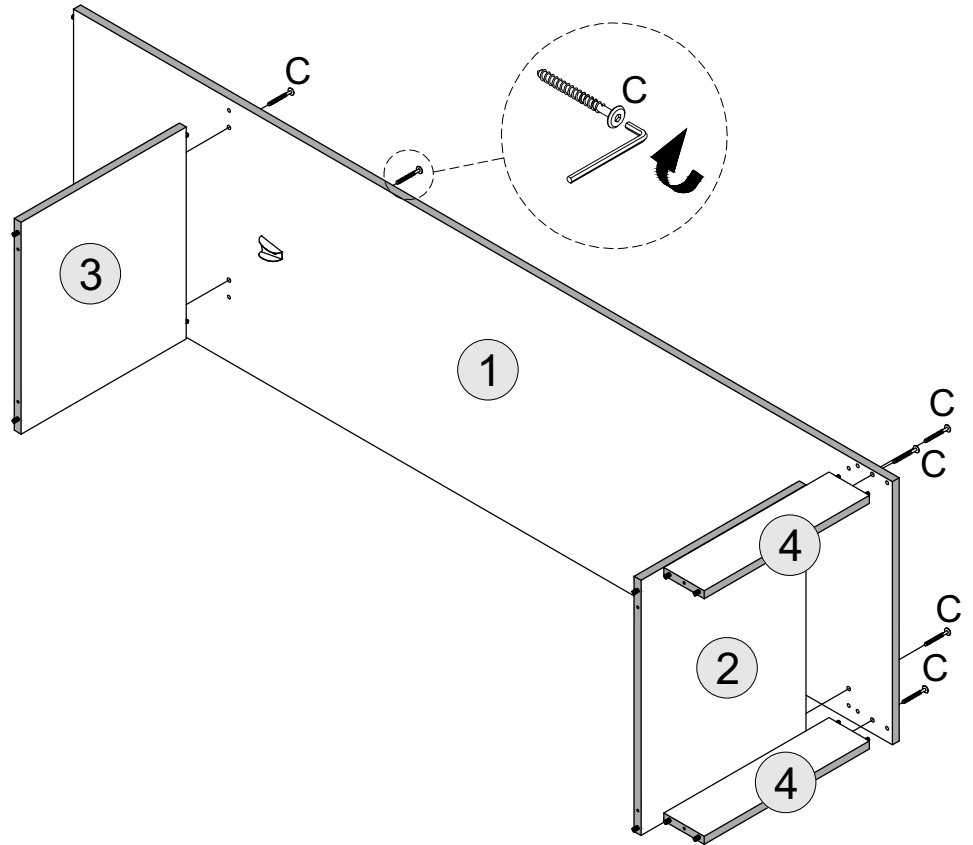

# STEP 6

PARTS REQUIRED

5 - SIDE PANEL - RIGHT	x1
------------------------	----

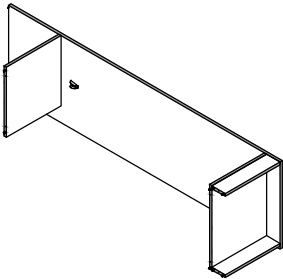

HARDWARE REQUIRED

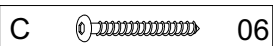

TOOLS REQUIRED

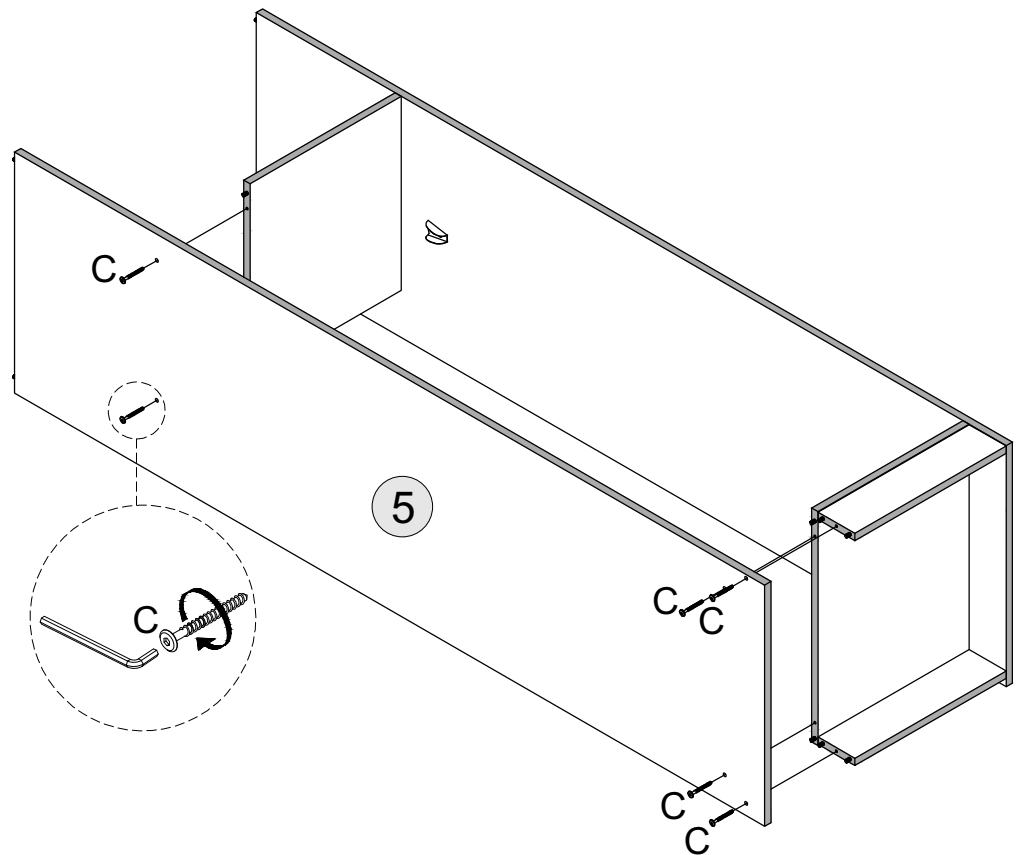

# STEP 7

**PARTS REQUIRED**

6 - TOP PANEL x1

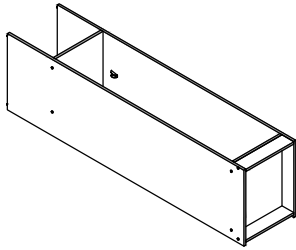

**HARDWARE REQUIRED**

D  04

F  04

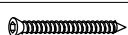
K  04

**TOOLS REQUIRED**

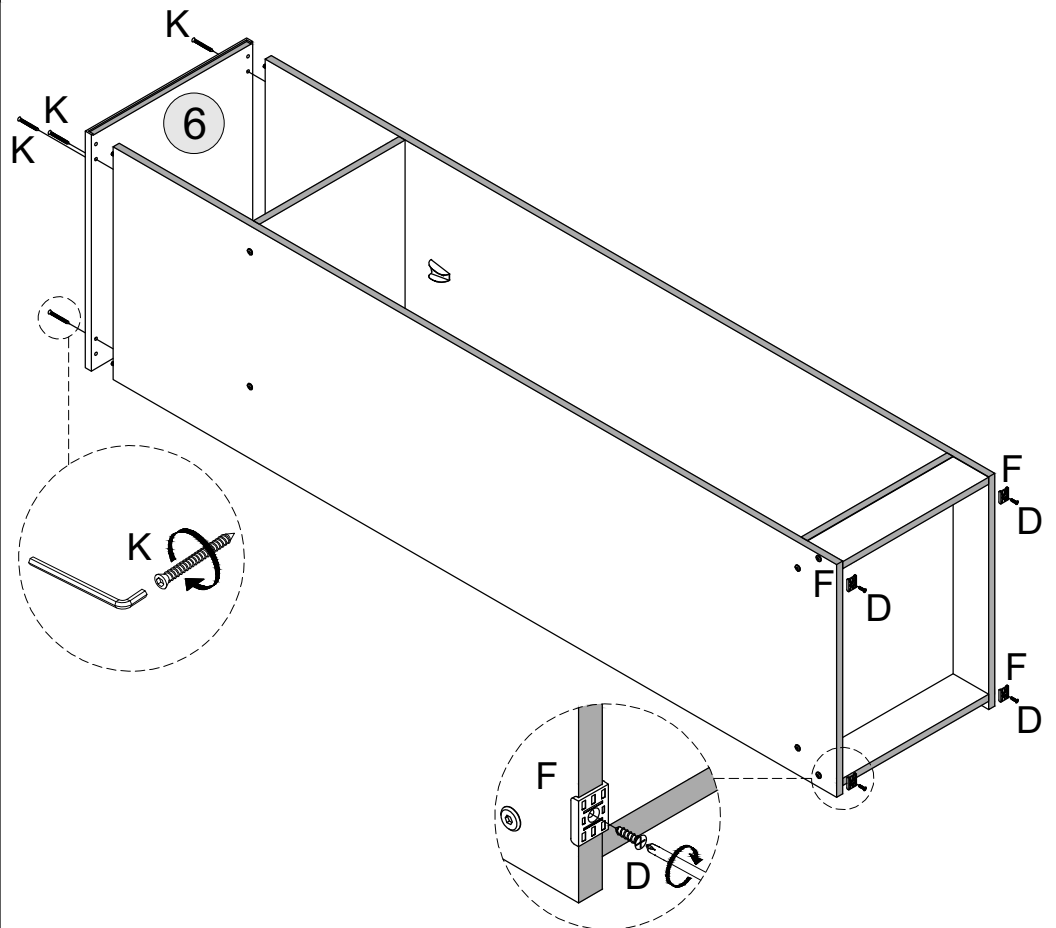
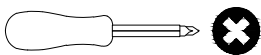

# STEP 8

**PARTS REQUIRED**

7 - BACK PANEL x1

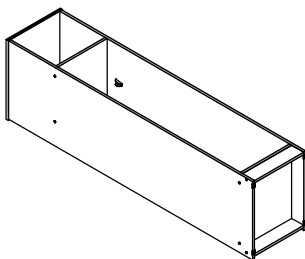

**HARDWARE REQUIRED**

E  40

**TOOLS REQUIRED**

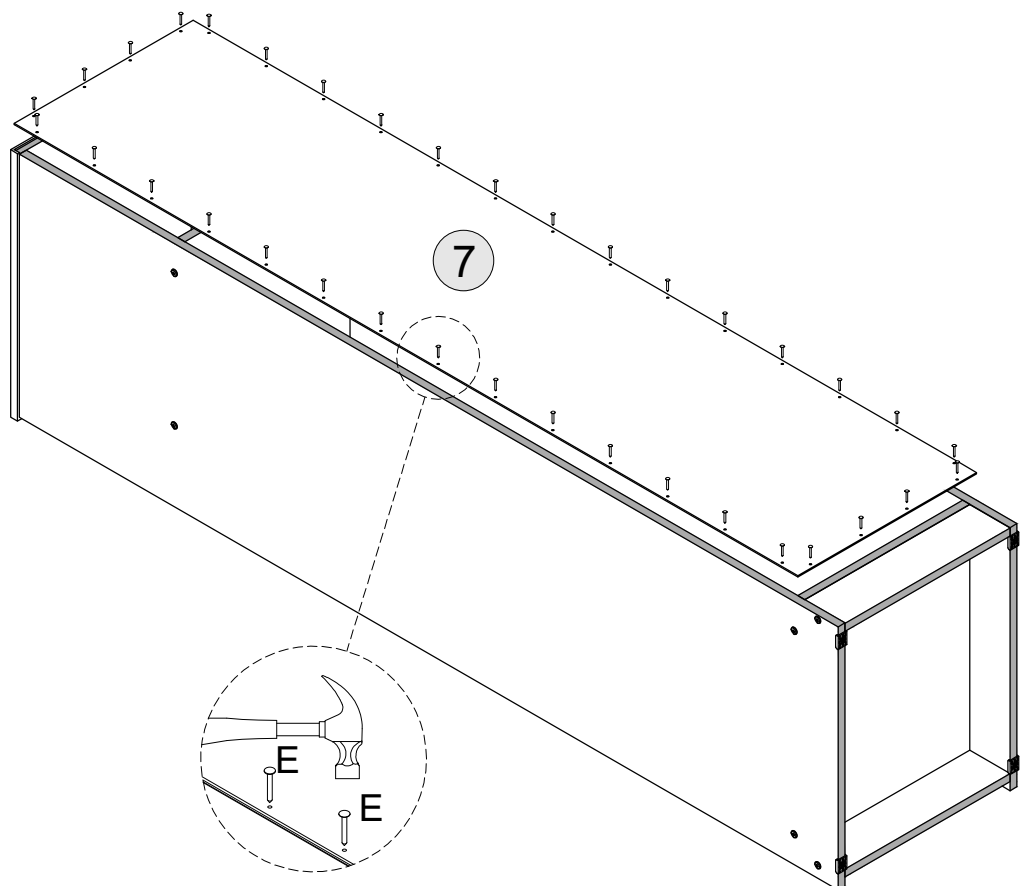
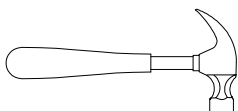

# STEP 9

**PARTS REQUIRED**

8 - DOOR x1

**HARDWARE REQUIRED**

D  06

L  03

**TOOLS REQUIRED**

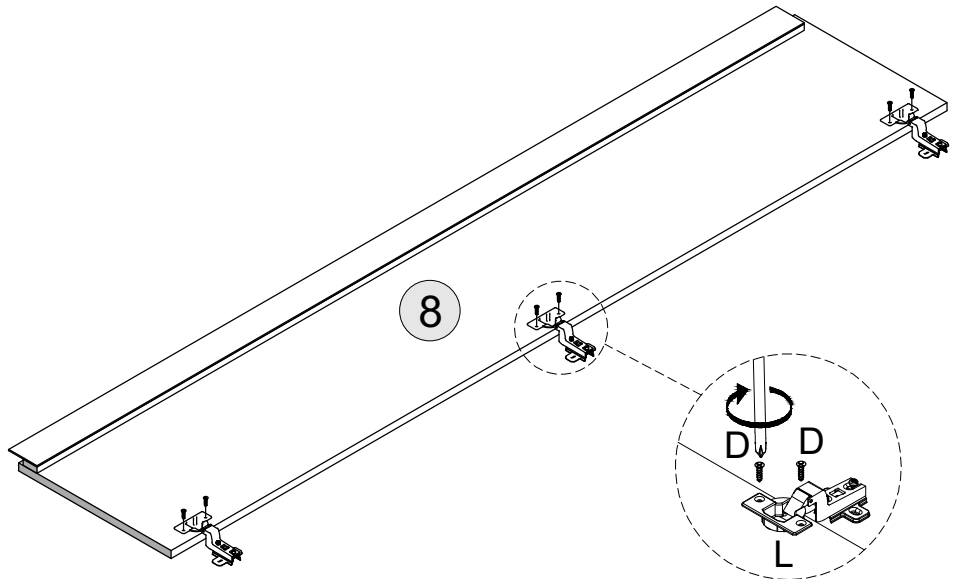
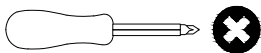

# STEP 10

**PARTS REQUIRED**

8 - DOOR x1

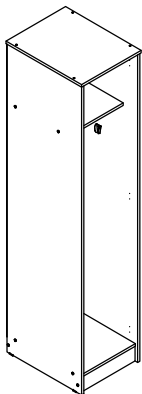

**HARDWARE REQUIRED**

H  06

J  01

**TOOLS REQUIRED**

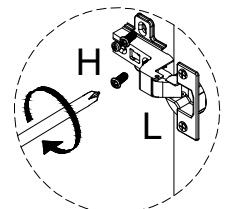
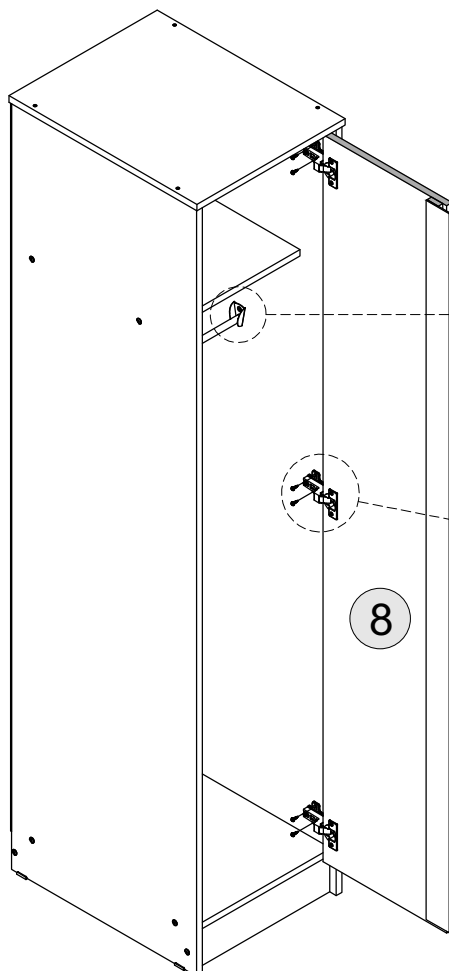
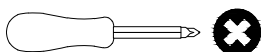

1. VERTICAL ADJUSTMENT VIA SLOT IN THE MOUNTING PLATE

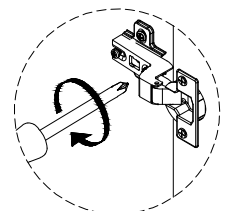

2. LATERAL ADJUSTMENT BY SCREW ADJUSTING

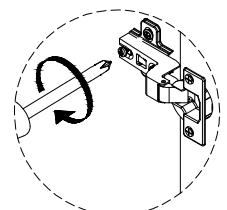

3. FRONT-TO-BACK BY THE SLACKING THE HINGE ARM MOUNTING SCREW

**YOU SHOULD RE-ADJUST SCREWS AS SHOWN TO ALIGN DOOR ONCE HINGES HAVE BEEN ATTACHED.**

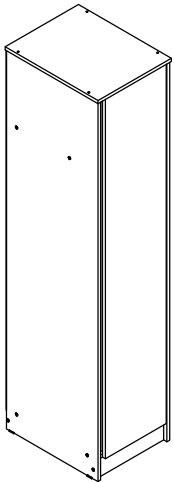
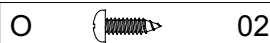
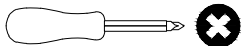

**STEP 11**PART REQUIREDHARDWARE REQUIREDTOOLS REQUIRED**WARNING**

Serious or fatal injuries can occur from furniture tipping over. To prevent the furniture from tipping over we recommend that it is permanently fixed to the wall.

Wall fixings are not supplied with this product as different wall materials require different types of fixing devices. Please make sure you use fixings suitable for the walls in your home.

