

LEON 2 DOOR 2 DRAWER CABINET ASSEMBLY INSTRUCTIONS

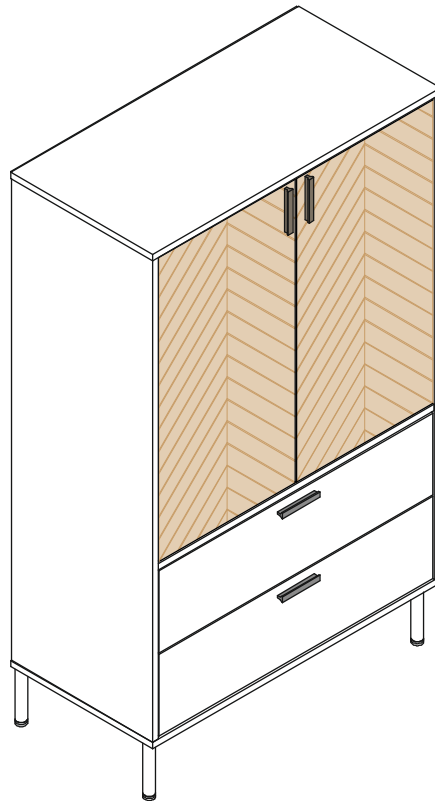

**FOR DOMESTIC USE ONLY
IMPORTANT**

PLEASE READ BEFORE YOU CONTINUE FURTHER

THE PRODUCT YOU HAVE PURCHASED WILL GIVE YOU MANY YEARS OF SERVICE IF YOU FOLLOW THE GUIDELINES FOR ITS SAFE ASSEMBLY AND PERIODIC MAINTENANCE AND CLEANING.

ASSEMBLE ON A SOFT CLEAN SURFACE.

DO NOT USE ANY TOOLS OTHER THAN THOSE SHOWN.

ANY SPANNERS OR ALLEN KEYS REQUIRED ARE INCLUDED WITH THE FITTING KIT.

DO NOT FOR ANY REASON USE A POWER TOOL TO ASSEMBLE THIS PRODUCT. ITS USE WILL INVALIDATE ANY CLAIM YOU MAY HAVE AND COULD MAKE THIS PRODUCT UNSAFE.

DEPENDING ON THE AMOUNT OF USE THIS PRODUCT RECEIVES, IT MAY BE NECESSARY TO TIGHTEN UP THE FIXINGS FROM TIME TO TIME. THIS IS COMPLETELY NORMAL FOR ANY FLAT PACK FURNITURE. DO NOT OVERTIGHTEN FIXINGS.

FOR CLEANING, YOU MAY USE A DAMP CLOTH (NOT WET). DO NOT USE POLISH, DETERGENT OR CHEMICAL CLEANERS.



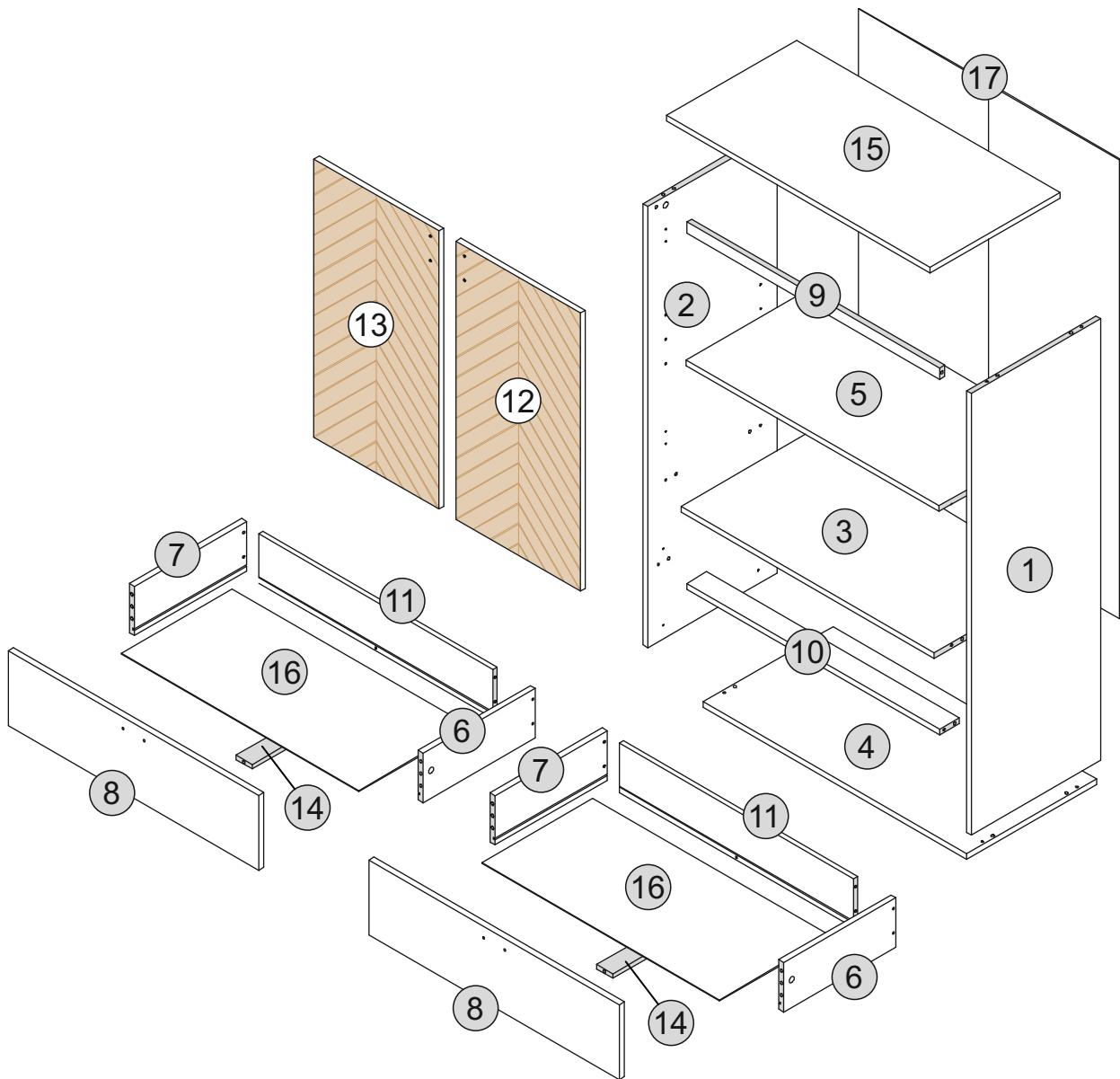













THIS SURFACE OF THIS ITEM IS NOT HEAT RESISTANT. ALWAYS USE A PLACE MAT UNDER HOT OR COLD ITEMS TO PREVENT MARKING.



PART LIST

| Part Number | Part Code | Part Description | Quantity | Carton |
|-------------|---------------------|-------------------------|----------|--------|
| 1 | S300-320-034-ZF1-01 | Right Side Panel | 1 | 1/2 |
| 2 | S300-320-034-ZF1-02 | Left Side Panel | 1 | 1/2 |
| 3 | S300-320-034-ZF1-03 | Shelf Panel | 1 | 1/2 |
| 4 | S300-320-034-ZF1-04 | Bottom Panel | 1 | 1/2 |
| 5 | S300-320-034-ZF1-05 | Top Shelf Panel | 1 | 1/2 |
| 6 | S300-320-034-ZF1-06 | Right Drawer Side Panel | 2 | 2/2 |
| 7 | S300-320-034-ZF1-07 | Left Drawer Side Panel | 2 | 2/2 |
| 8 | S300-320-034-ZF1-08 | Drawer Front | 2 | 2/2 |
| 9 | S300-320-034-ZF1-09 | Top Support Panel | 1 | 2/2 |
| 10 | S300-320-034-ZF1-10 | Support Panel | 1 | 2/2 |
| 11 | S300-320-034-ZF1-11 | Drawer Back Panel | 2 | 2/2 |
| 12 | S300-320-034-ZF1-12 | Right Door | 1 | 1/2 |
| 13 | S300-320-034-ZF1-13 | Left Door | 1 | 1/2 |
| 14 | S300-320-034-ZF1-14 | Drawer Support Panel | 2 | 2/2 |
| 15 | S300-320-034-ZF1-15 | Top Panel | 1 | 1/2 |
| 16 | S300-320-034-ZF1-16 | Drawer Base | 2 | 2/2 |
| 17 | S300-320-034-ZF1-17 | Back Panel | 1 | 1/2 |

HARDWARE LIST

| No | Part Name | | Qty | Carton |
|----|---|---|-----|--------|
| A | M8x30mm Wooden Dowel |  | x24 | 1 |
| B | Minifix Cam Bolt <small>(8032l)</small> |  | x16 | 1 |
| C | Minifix Cam Nut <small>(1512)</small> |  | x14 | 1 |
| D | M3.5x16mm Screw |  | x50 | 1 |
| E | M4x45mm Screw |  | x4 | 1 |
| F | Iron Leg <small>(150mm) - Black</small> |  | x4 | 1 |
| G | 20mm Handle Screw |  | x8 | 1 |
| H | Handle <small>(64mm)</small> |  | x4 | 1 |
| I | End Hinges <small>(M11)</small> |  | x4 | 1 |
| J | Nail |  | x44 | 1 |
| K | Screw Cover <small>(Sticker 22mm)</small> |  | x4 | 1 |
| L | Shelf Support |  | x4 | 1 |
| M | Wall Fixing <small>(4x20mm=1pc)</small> |  | x1 | 1 |
| N | PVC L-Bracket |  | x1 | 1 |
| O | 14" Drawer Slide <small>(VKT 0.9 - Black)</small> |  | x2 | 1 |
| P | M4x38mm Screw |  | x10 | 1 |
| Q | Minifix Cam Nut <small>(1510)</small> |  | x2 | 1 |

TIPS FOR FITTINGS CAM-LOCKS

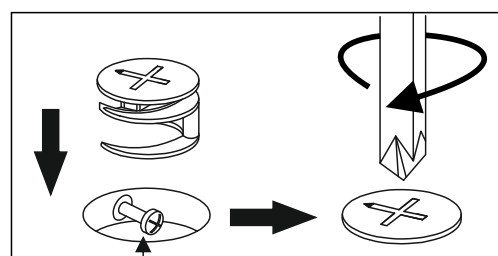
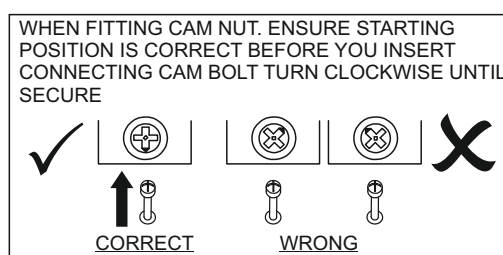

Cam bolt head needs to be in centre

CAMBOLT

Tighten until shoulder in flush with panel. Do not overtighten or undertighten (see example below)

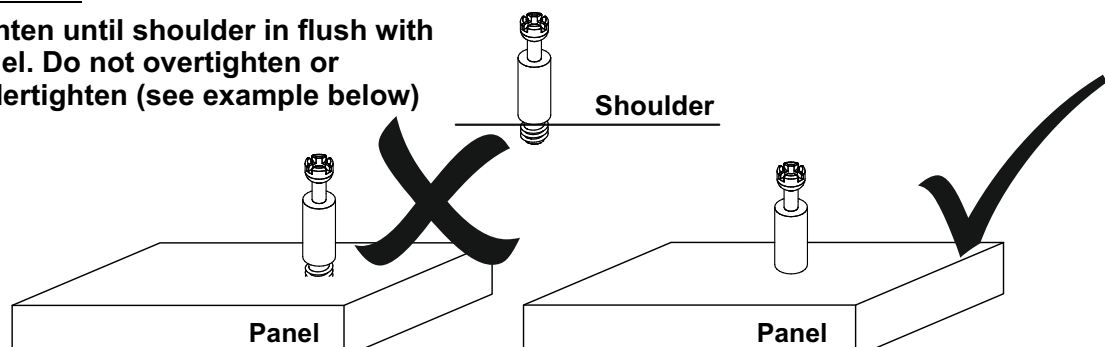





STEP 1

PARTS REQUIRED

| | |
|-----------------------|----|
| 3 - SHELF PANEL | x1 |
| 9 - TOP SUPPORT PANEL | x1 |
| 10 - SUPPORT PANEL | x1 |
| 15 - TOP PANEL | x1 |

HARDWARE REQUIRED

| | | |
|---|---|----|
| A |  | 08 |
| B |  | 04 |
| C |  | 06 |
| D |  | 01 |
| N |  | 01 |

TOOLS REQUIRED

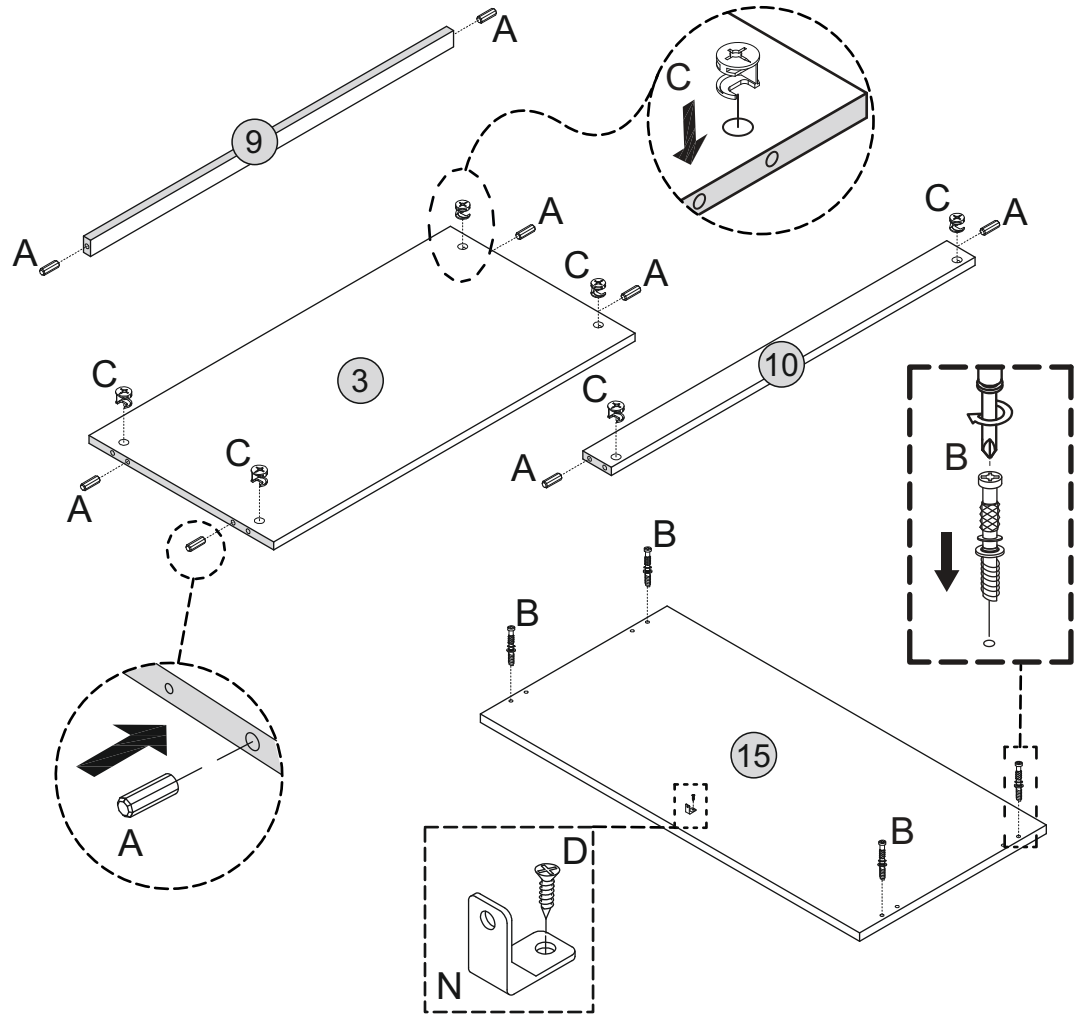
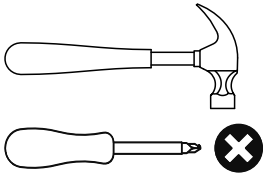





STEP 2

PARTS REQUIRED

| | |
|----------------------|----|
| 1 - RIGHT SIDE PANEL | x1 |
| 2 - LEFT SIDE PANEL | x1 |

HARDWARE REQUIRED

| | | |
|---|---|----|
| A |  | 08 |
| B |  | 06 |
| D |  | 08 |
| O |  | 02 |

TOOLS REQUIRED

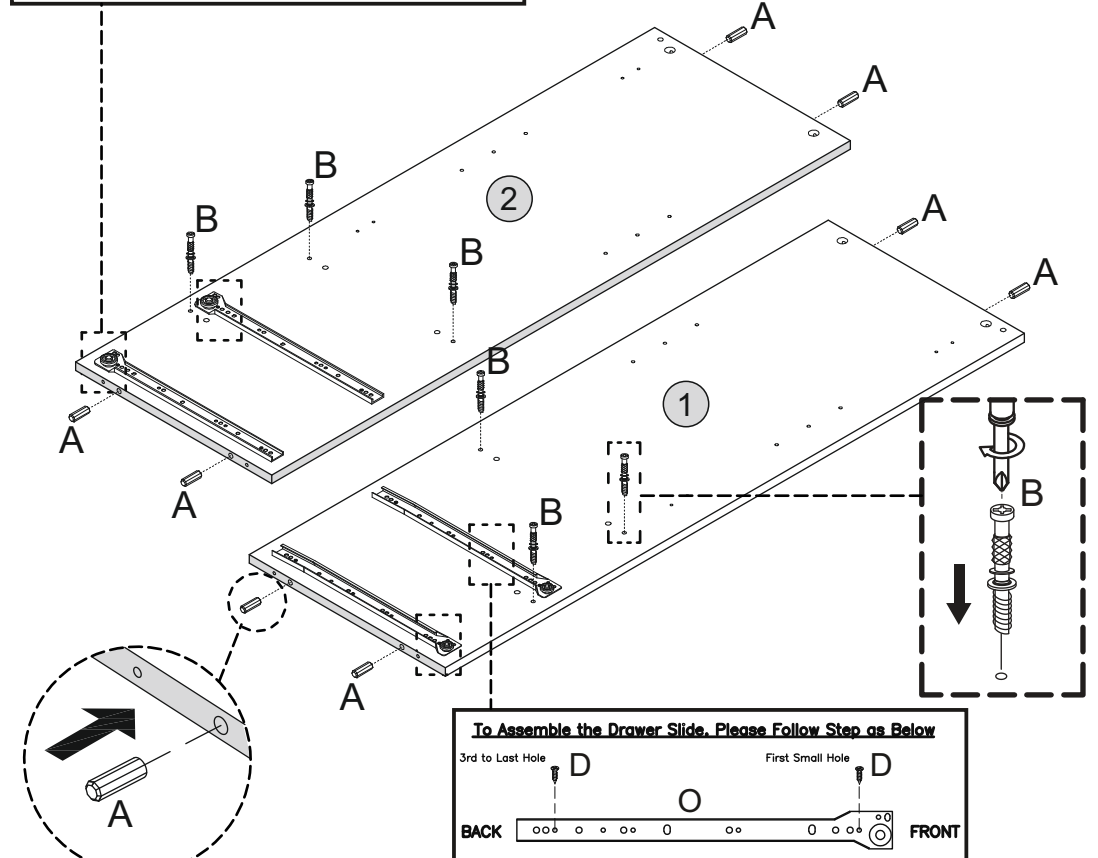
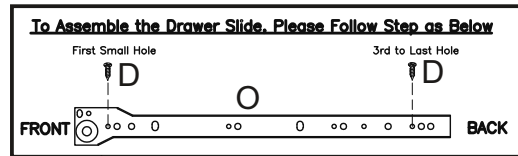
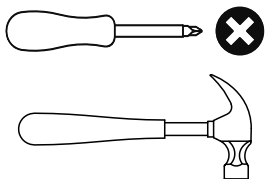

STEP 3

PARTS REQUIRED

1 - RIGHT SIDE PANEL x1

2 - LEFT SIDE PANEL x1

HARDWARE REQUIRED

C  04

L  04

TOOLS REQUIRED

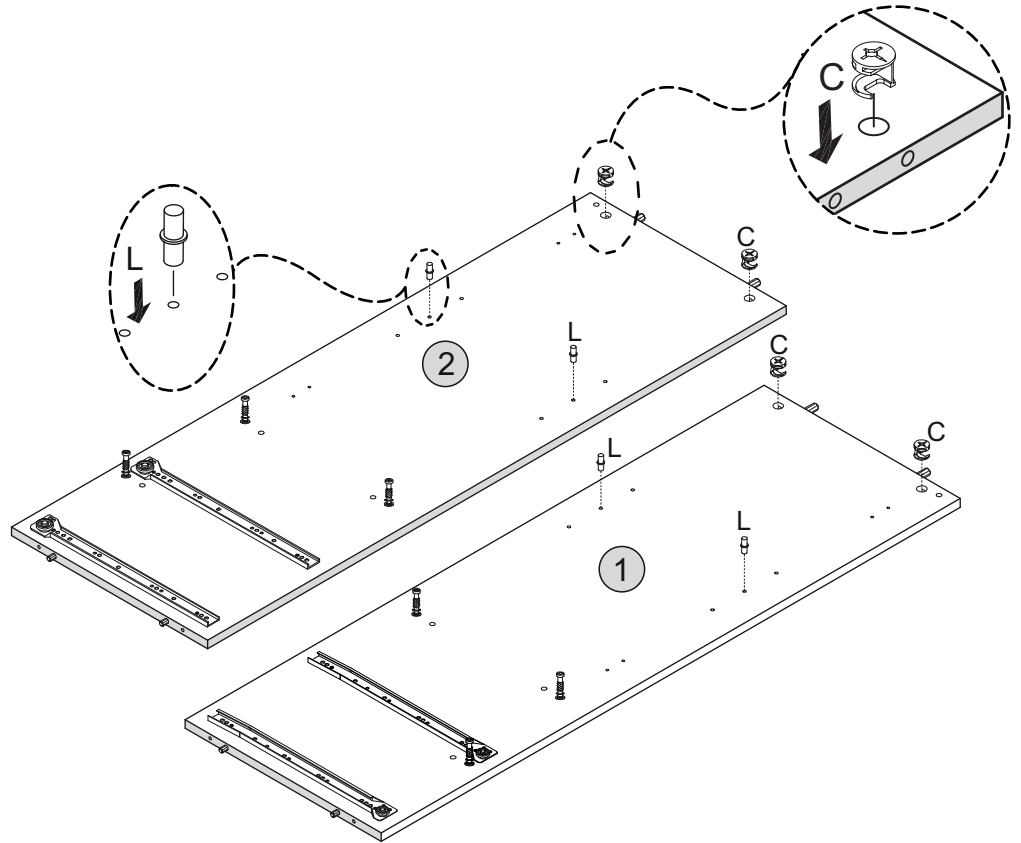
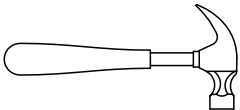

STEP 4

PARTS REQUIRED

2 - LEFT SIDE PANEL x1

3 - SHELF PANEL x1

10 - SUPPORT PANEL x1

HARDWARE REQUIRED

TOOLS REQUIRED

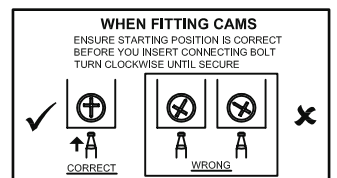
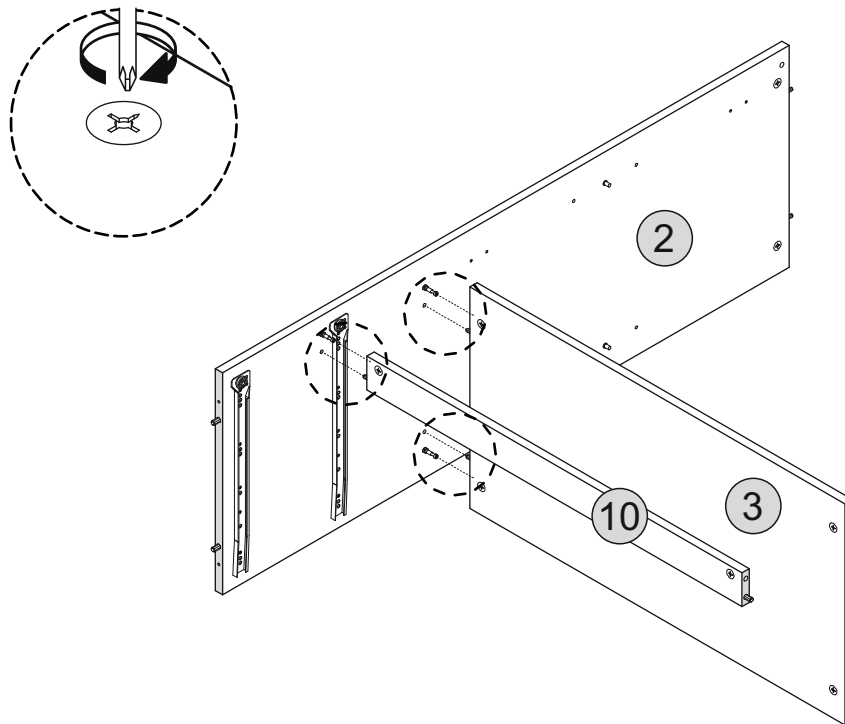
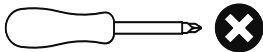

STEP 5

PARTS REQUIRED

- 1 - RIGHT SIDE PANEL x1
- 9 - TOP SUPPORT PANEL x1

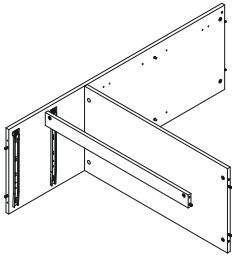

HARDWARE REQUIRED

TOOLS REQUIRED

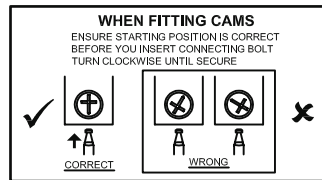
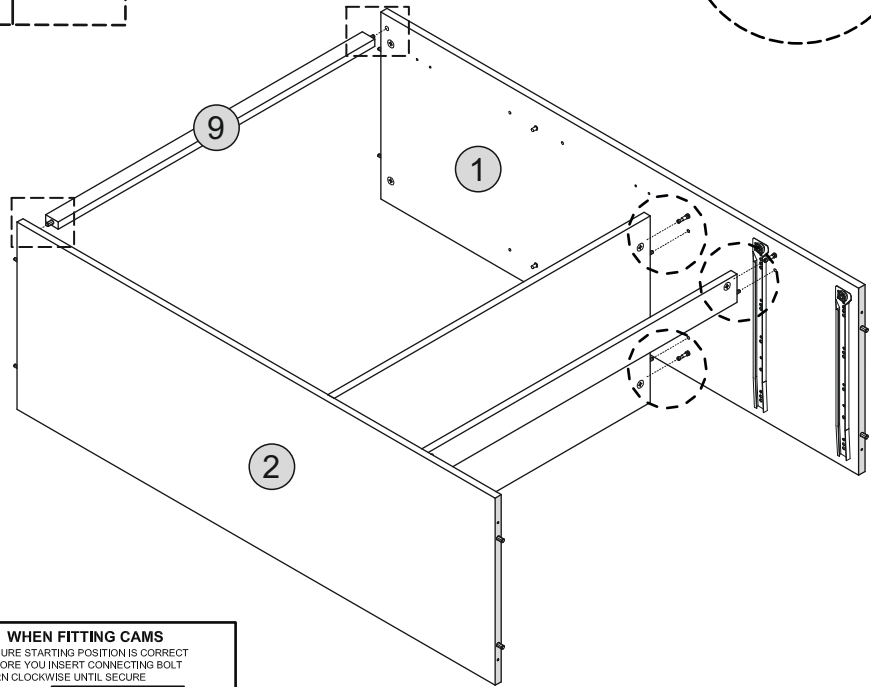
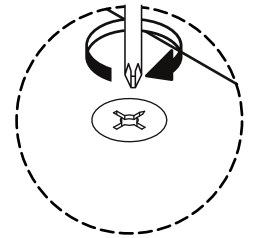
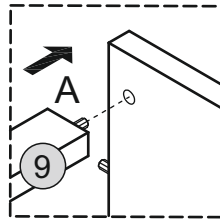
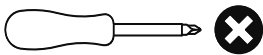



STEP 6

PARTS REQUIRED

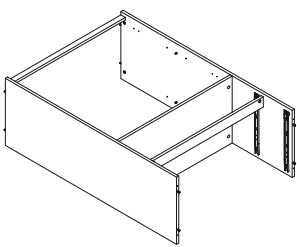
- 15 - TOP PANEL x1



HARDWARE REQUIRED

- D  3.5x16mm 01
- K  04

TOOLS REQUIRED

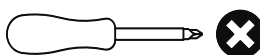

BOTTOM VIEW

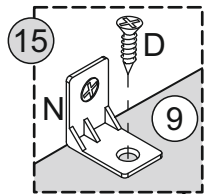

STEP 1

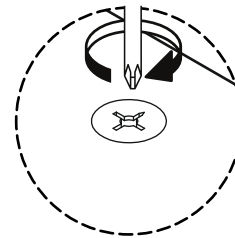

STEP 2

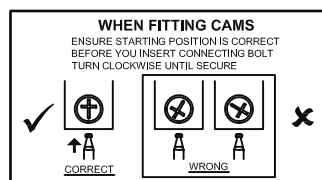
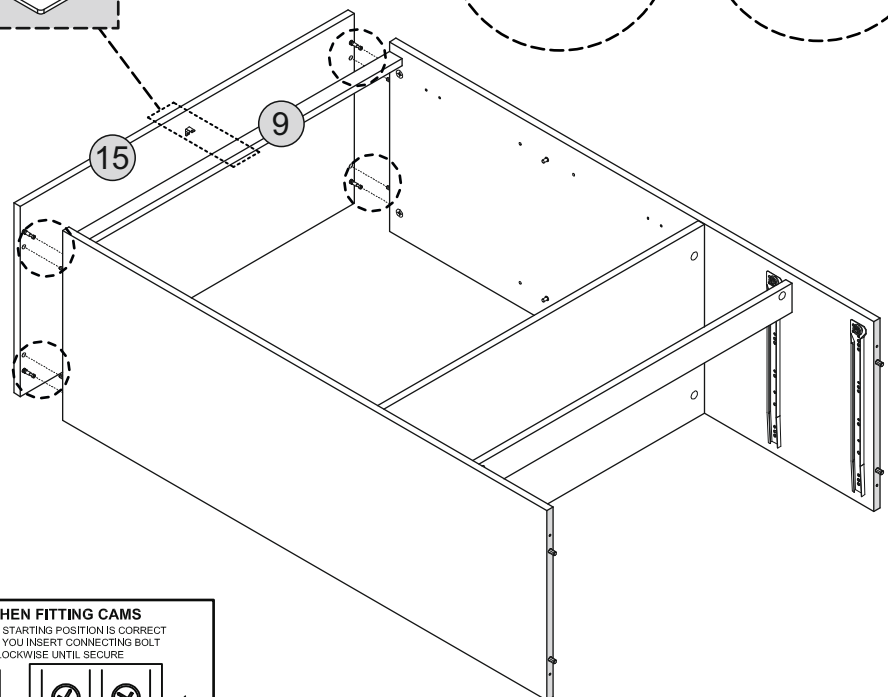
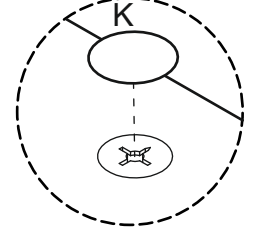

STEP 7

PARTS REQUIRED

4 - BOTTOM PANEL x1

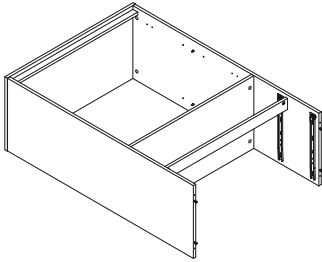

HARDWARE REQUIRED

E  04
4x45mm

TOOLS REQUIRED

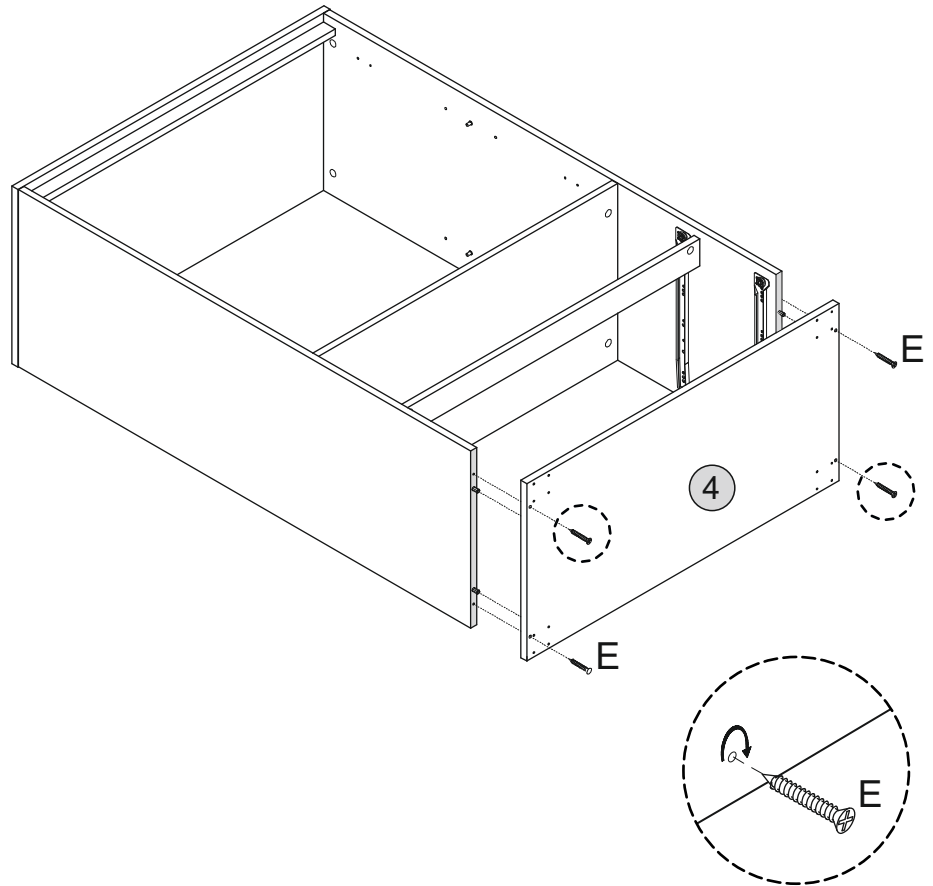
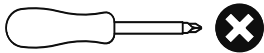

STEP 8

PARTS REQUIRED

17 - BACK PANEL x1

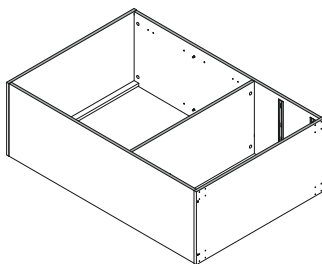

HARDWARE REQUIRED

D  16
3.5x16mm

F  04

J  44

TOOLS REQUIRED

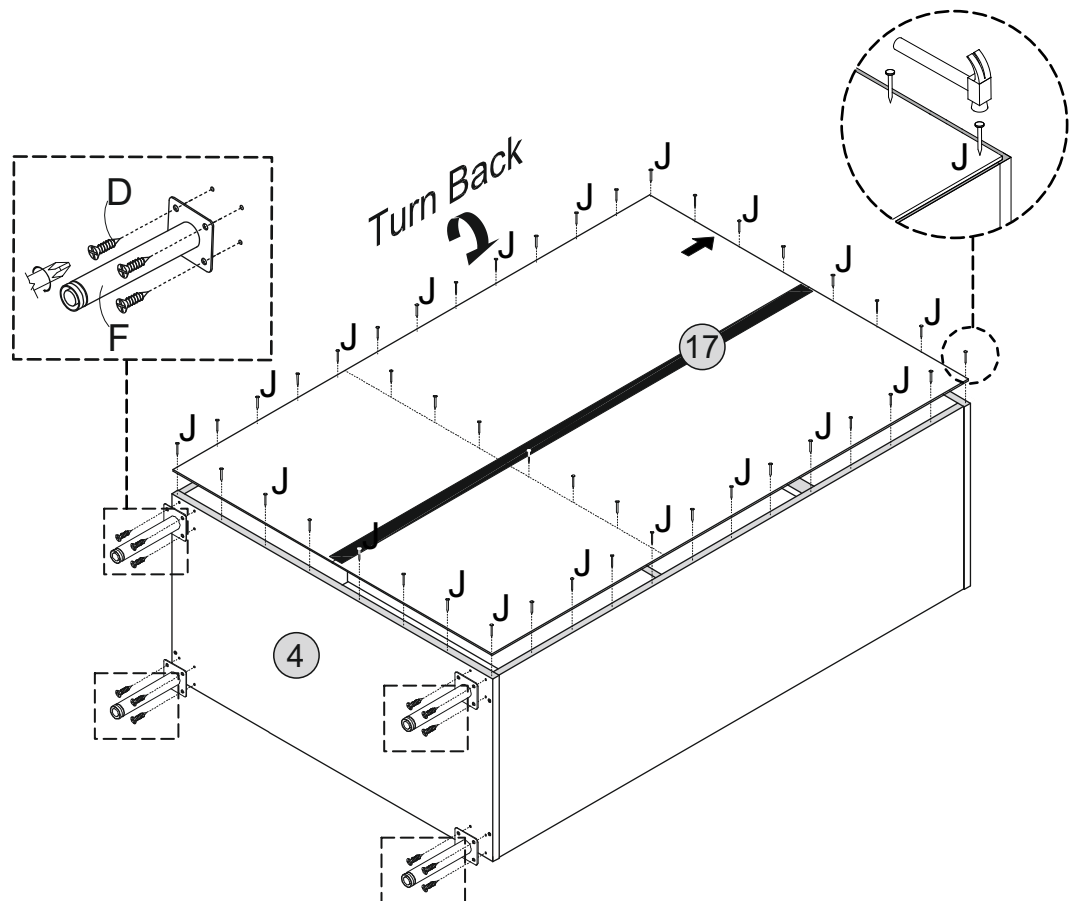
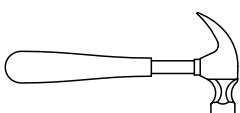
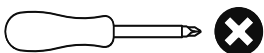

STEP 9

PARTS REQUIRED

6 - RIGHT DRAWER SIDE x2

7 - LEFT DRAWER SIDE x2

8 - DRAWER FRONT x2

14 - DRAWER SUPPORT x2

HARDWARE REQUIRED

A  08

B  06

C  04

Q  02

TOOLS REQUIRED

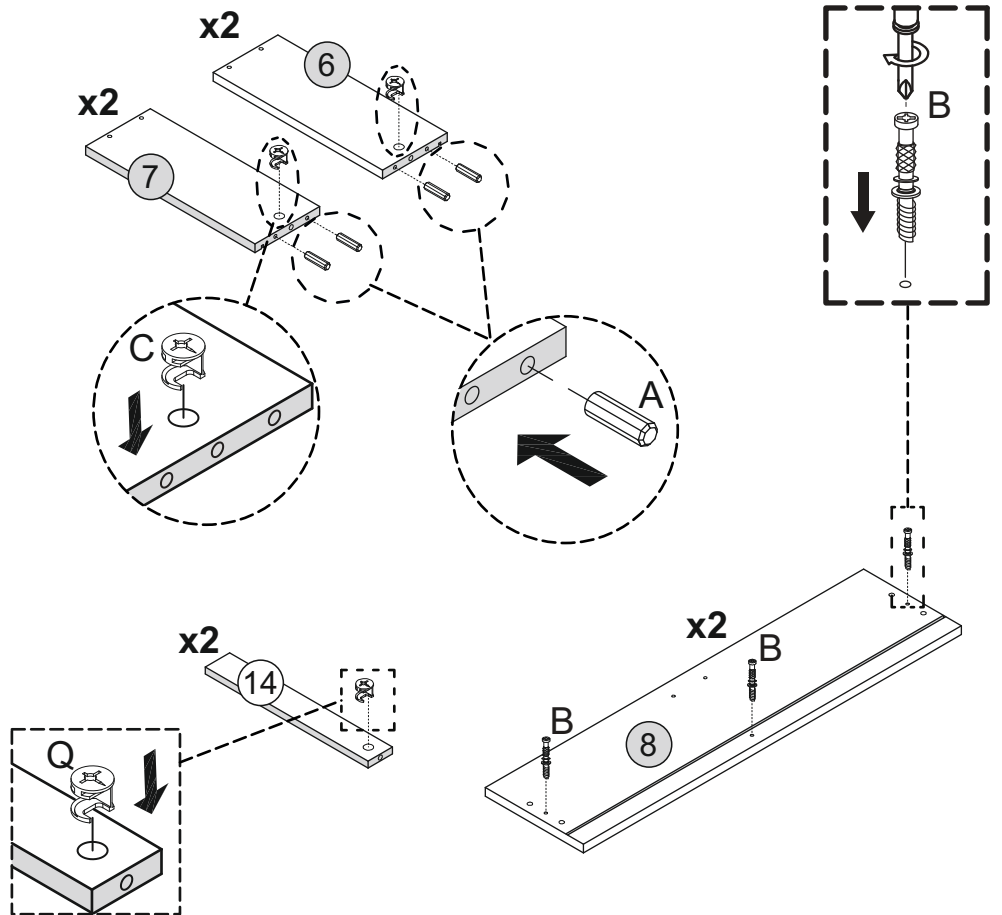
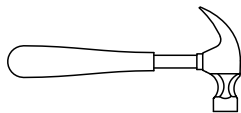
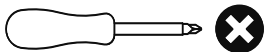

STEP 10

PARTS REQUIRED

6 - RIGHT DRAWER SIDE x2

7 - LEFT DRAWER SIDE x2

11 - DRAWER BACK x2

14 - DRAWER SUPPORT x2

16 - DRAWER BASE x2

HARDWARE REQUIRED

P  10
4x38mm

TOOLS REQUIRED

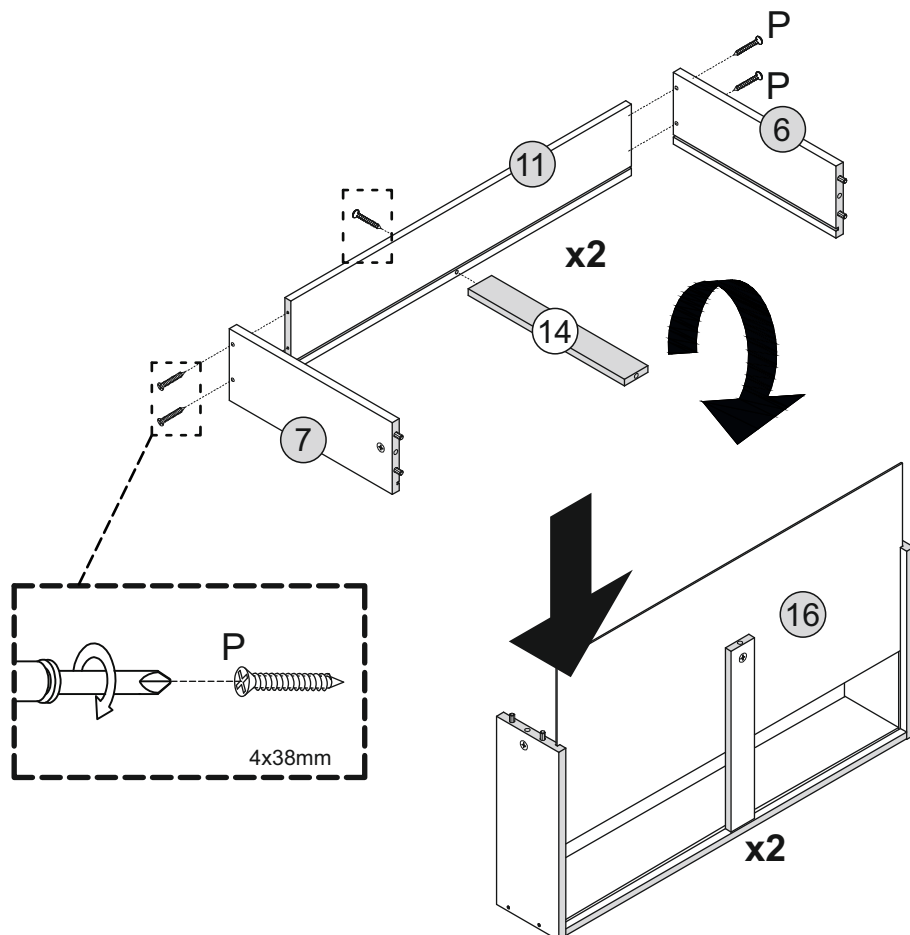
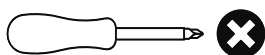

STEP 11

PARTS REQUIRED

8 - DRAWER FRONT x2

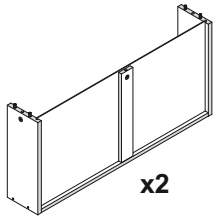

HARDWARE REQUIRED

TOOLS REQUIRED

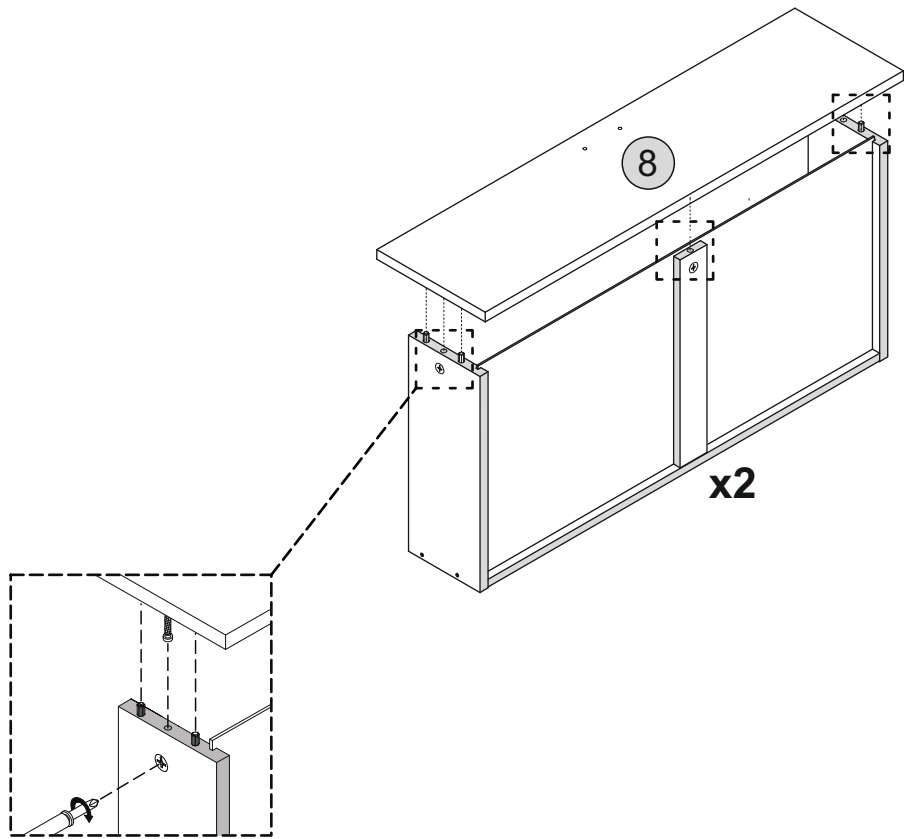
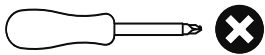

STEP 12

PARTS REQUIRED

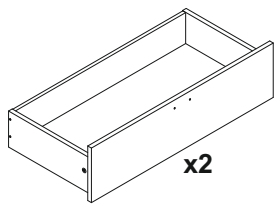

HARDWARE REQUIRED

G  04

H  02

TOOLS REQUIRED

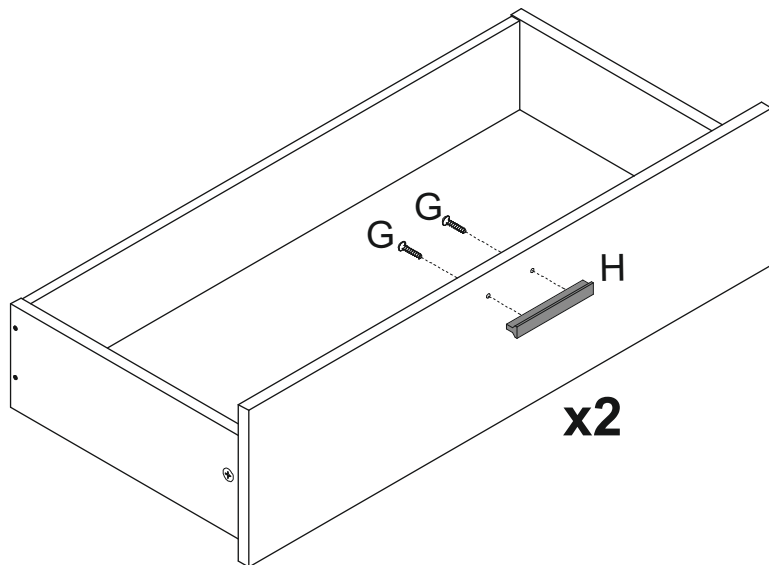
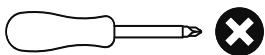

STEP 13

PARTS REQUIRED

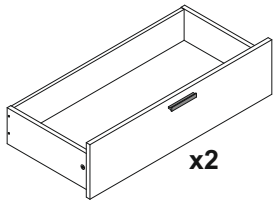

HARDWARE REQUIRED



TOOLS REQUIRED

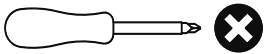

FRONT

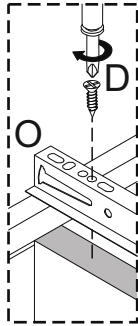

Turn Back

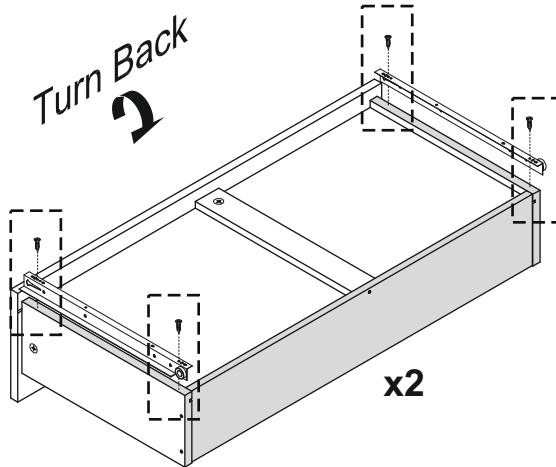

BACK

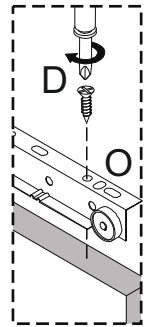

STEP 14

PARTS REQUIRED

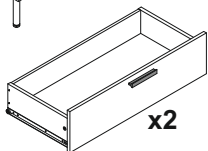
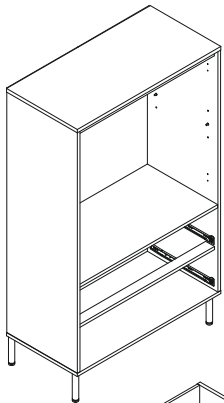

HARDWARE REQUIRED

TOOLS REQUIRED

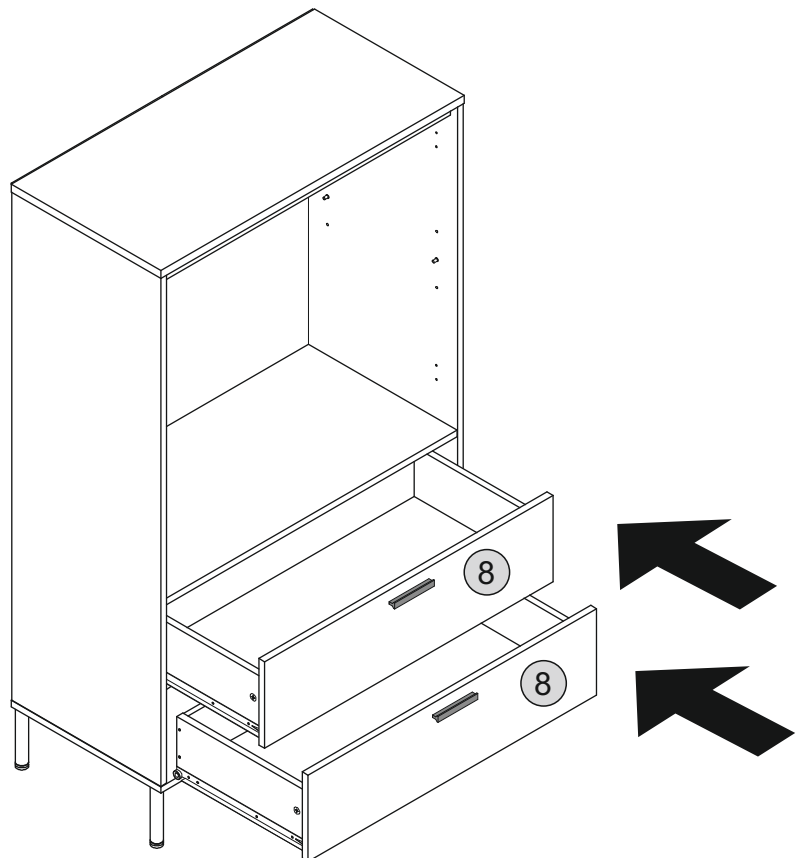

STEP 15

PARTS REQUIRED

5 - TOP SHELF PANEL x1

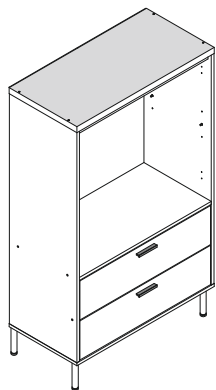

HARDWARE REQUIRED

TOOLS REQUIRED

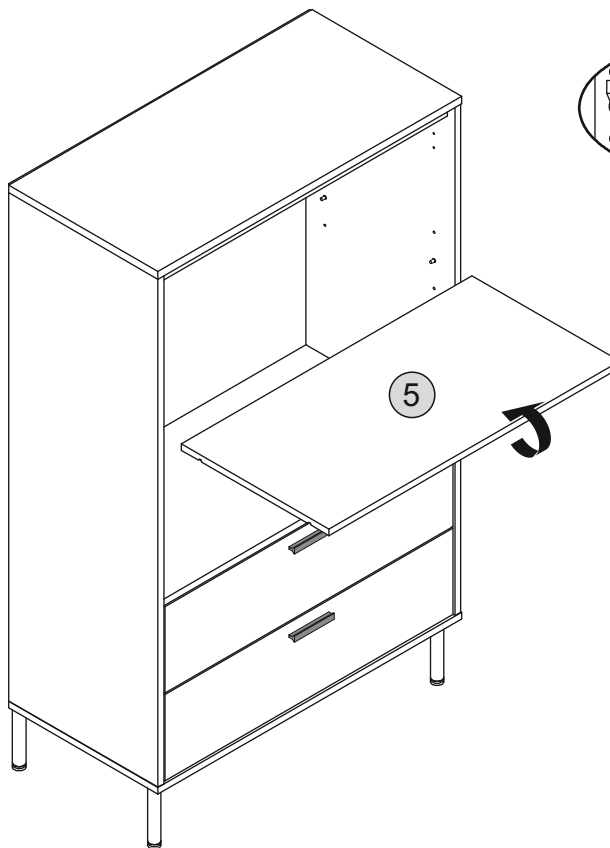

STEP 16

PARTS REQUIRED

12 - RIGHT DOOR x1

13 - LEFT DOOR x1

HARDWARE REQUIRED

D  08

I  04

TOOLS REQUIRED

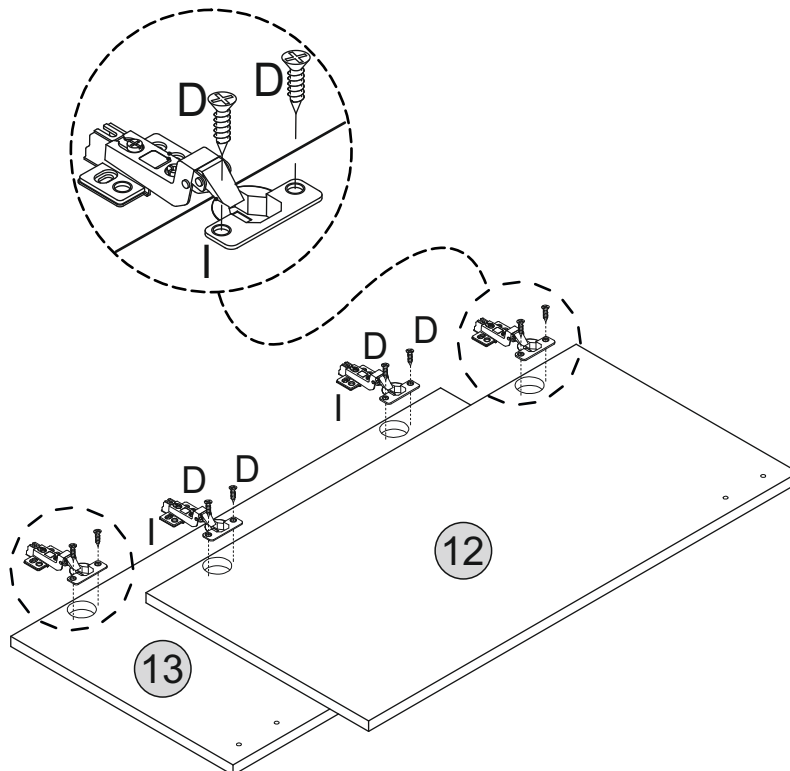
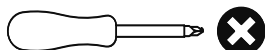



STEP 17

PARTS REQUIRED

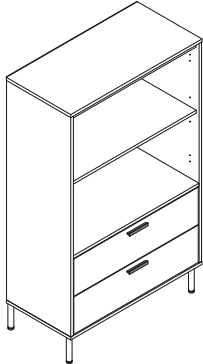
- 12 - RIGHT DOOR x1
- 13 - LEFT DOOR x1



HARDWARE REQUIRED

- D  08
3.5x16mm
- G  04
- H  02

TOOLS REQUIRED

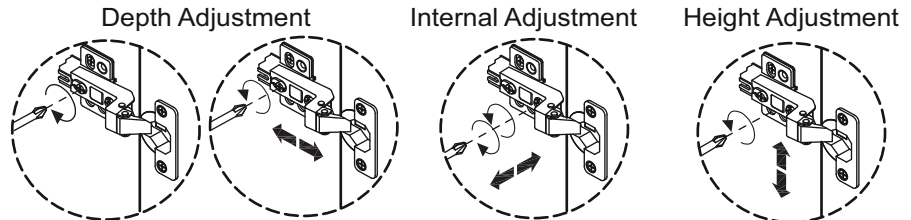
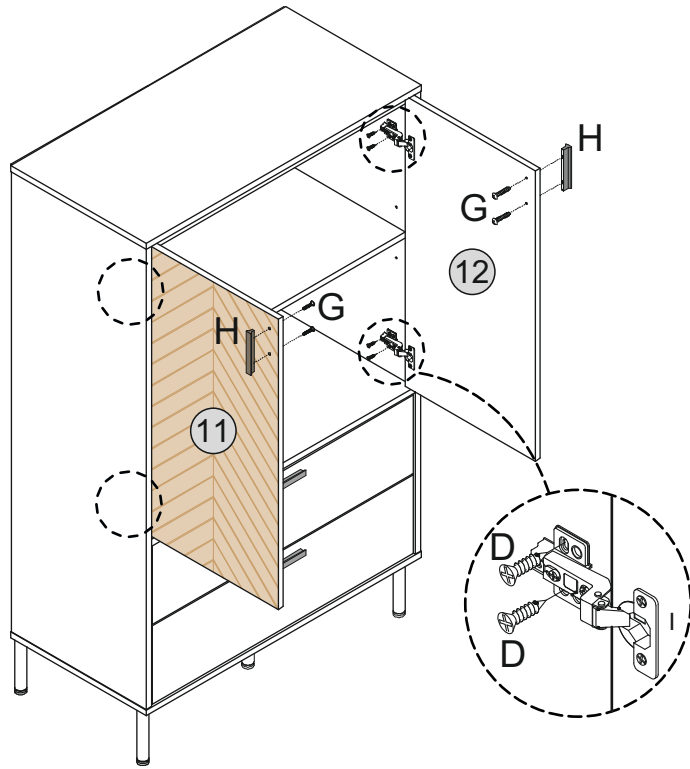
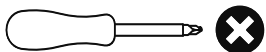

STEP 18

PARTS REQUIRED

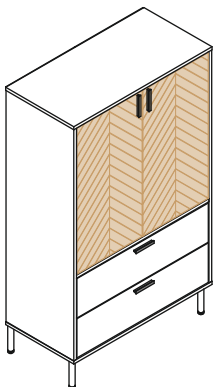

HARDWARE REQUIRED

- M  01

TOOLS REQUIRED

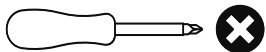

WARNING

Serious or fatal injuries can occur from furniture tipping over. To prevent the furniture from tipping over we recommend that it is permanently fixed to the wall.

Wall fixings are not supplied with this product as different wall materials require different types of fixing devices. Please make sure you use fixings suitable for the walls in your home.

