

BROOKLYN

2 DOOR 2 DRAWER STORAGE CHEST

ASSEMBLY INSTRUCTIONS

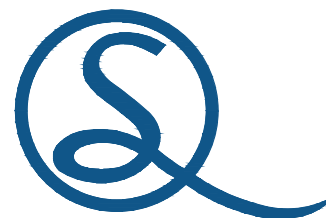
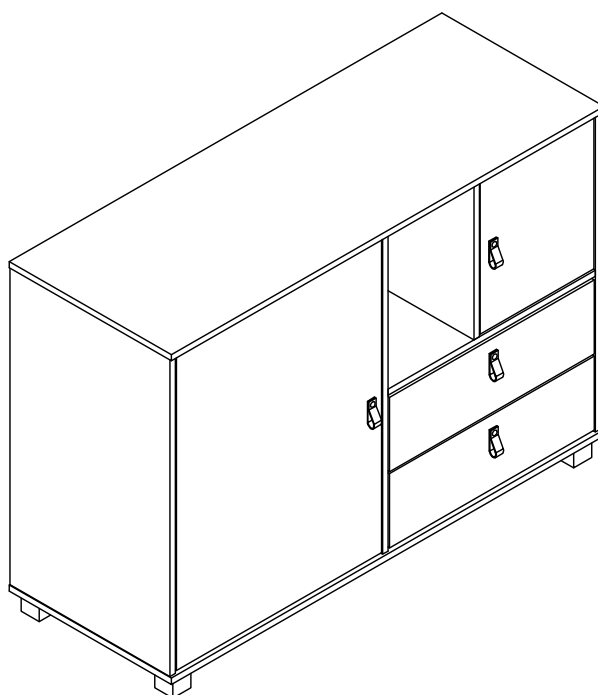
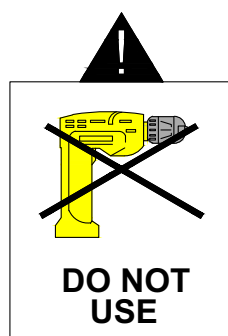

IMPORTANT FOR DOMESTIC USE ONLY PLEASE READ BEFORE YOU CONTINUE FURTHER

THE PRODUCT YOU HAVE PURCHASED WILL GIVE YOU MANY YEARS OF SERVICE IF YOU FOLLOW THE GUIDELINES FOR ITS SAFE ASSEMBLY AND PERIODIC MAINTENANCE AND CLEANING.

ASSEMBLE ON A SOFT CLEAN SURFACE.

DO NOT USE ANY TOOLS OTHER THAN THOSE SHOWN.

ANY SPANNERS OR ALLEN KEYS REQUIRED ARE INCLUDED WITH THE FITTINGS KIT.

DO NOT FOR ANY REASON USE A POWER TOOL TO ASSEMBLE THIS PRODUCT. ITS USE WILL INVALIDATE ANY CLAIM YOU MAY HAVE AND COULD MAKE THIS PRODUCT UNSAFE.

DEPENDING ON THE AMOUNT OF USE THIS PRODUCT RECEIVES IT MAY BE NECESSARY TO TIGHTEN UP THE FIXINGS FROM TIME TO TIME. THIS IS COMPLETELY NORMAL FOR ANY FLAT PACK FURNITURE. DO NOT OVERTIGHTEN FIXING.

FOR CLEANING, YOU MAY USE A DAMP CLOTH (NOT WET) DO NOT USE POLISH, DETERGENT OR CHEMICAL CLEANERS.



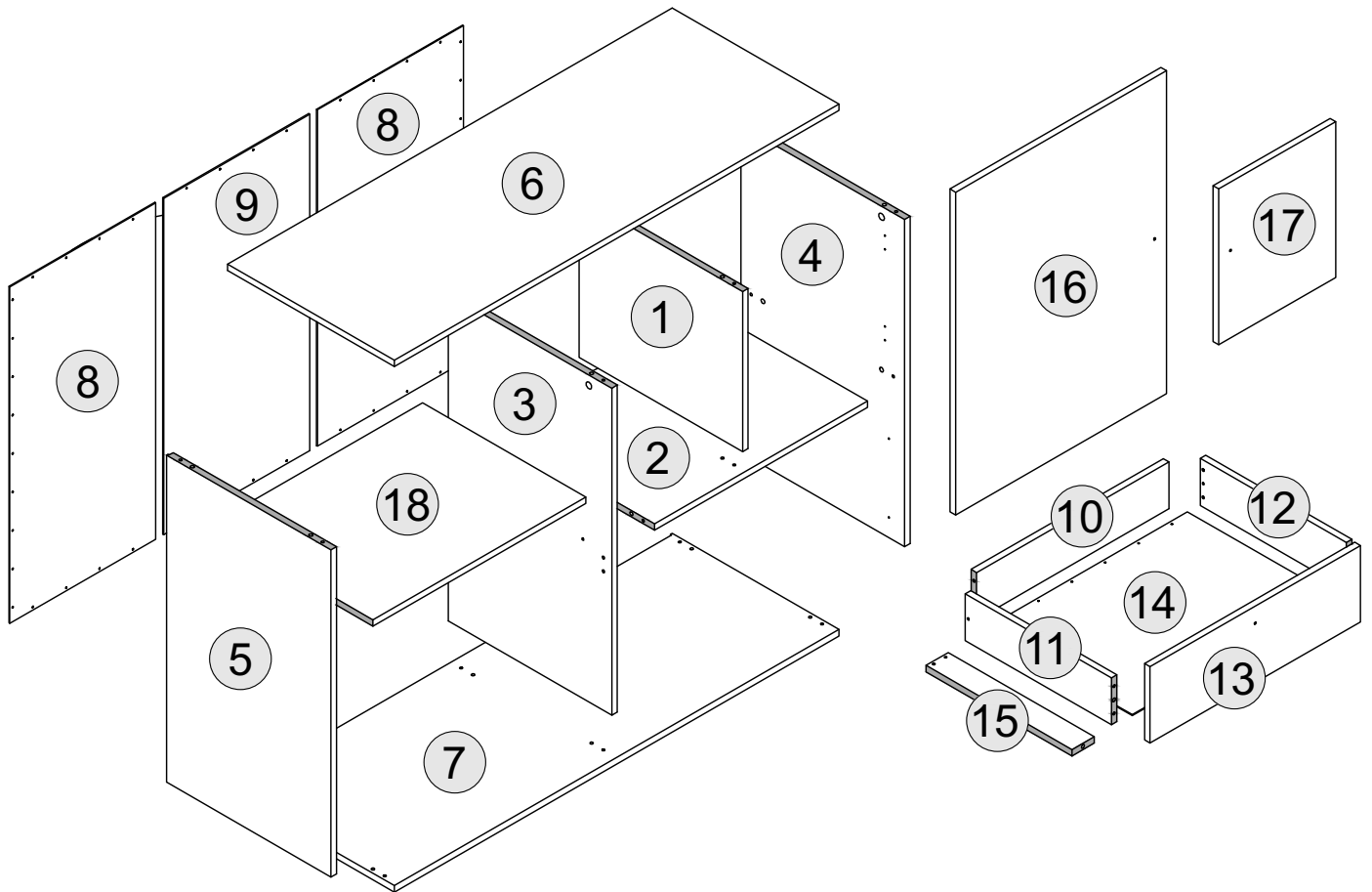







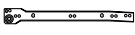







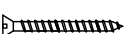

THE SURFACE OF THIS ITEM IS NOT HEAT RESISTANT. ALWAYS USE A PLACE MAT UNDER HOT OR COLD ITEMS TO PREVENT MARKING.



PART LIST

<u>Part Number</u>	<u>Part Code</u>	<u>Part Description</u>	<u>Quantity</u>	<u>Carton</u>
1	S100-120-022-EU1-01	Small Centre Panel	1	1/2
2	S100-120-022-EU1-02	Shelf Panel - Right	1	1/2
3	S100-120-022-EU1-03	Large Centre Panel	1	2/2
4	S100-120-022-EU1-04	Side Panel - Right	1	2/2
5	S100-120-022-EU1-05	Side Panel - Left	1	2/2
6	S100-120-022-EU1-06	Top Panel	1	1/2
7	S100-120-022-EU1-07	Bottom Panel	1	1/2
8	S100-120-022-EU1-08	Side Back Panel	2	1/2
9	S100-120-022-EU1-09	Centre Back Panel	1	1/2
10	S100-120-022-EU1-10	Drawer Back	2	2/2
11	S100-120-022-EU1-11	Drawer Side - Left	2	2/2
12	S100-120-022-EU1-12	Drawer Side - Right	2	2/2
13	S100-120-022-EU1-13	Drawer Front	2	2/2
14	S100-120-022-EU1-14	Drawer Base	2	1/2
15	S100-120-022-EU1-15	Drawer Bottom Support Rail	2	2/2
16	S100-120-022-EU1-16	Large Door	1	2/2
17	S100-120-022-EU1-17	Small Door	1	2/2
18	S100-120-022-EU1-18	Shelf Panel - Left	1	2/2

HARDWARE LIST

A		DOWEL 6 X 30MM	36 PCS	O		DRAWER RUNNER A - L/R	4 PCS
B		CAM BOLT + CAM NUT	18 PCS	P		DRAWER RUNNER B - L/R	4 PCS
C		SCREW M6 X 50MM	8 PCS	Q		SCREW M4 X 30MM	4 PCS
D		SCREW M3.5 X 16MM	22 PCS	R		HANDLE SCREW 19MM	4 PCS
E		TACK	38 PCS	S		SCREW M3.5 X 12MM	28 PCS
F		SCREW M4 X 50MM	20 PCS	T		SCREW M4 X 38MM	4 PCS
G		HANDLE	4 PCS	U		ANTI - TIP STRAP	2 PCS
H		TAPPING SCREW M8 X 12MM	8 PCS	V		SCREW M4 X 16MM	2 PCS
I		WOOD FOOT	5 PCS				
J		ALLEN KEY	1 PC				
K		PLASTIC H STRIP	2 PCS				
L		SHELF SUPPORT	4 PCS				
M		PVC STOPPER	2 PCS				
N		HINGES 7/8	4 PCS				

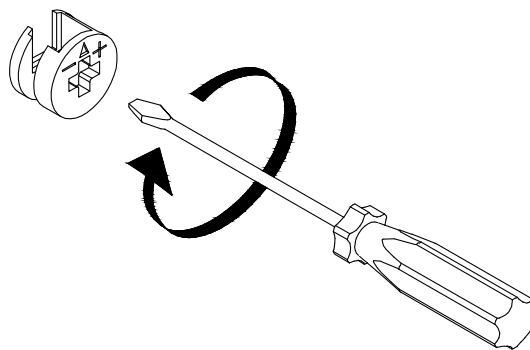

(SCREWDRIVER NOT PROVIDED)

USE A FLAT HEAD SCREWDRIVER TO TIGHTEN THE CAM NUTS. A QUARTER TURN CLOCKWISE IS ALL THAT IS NEEDED.

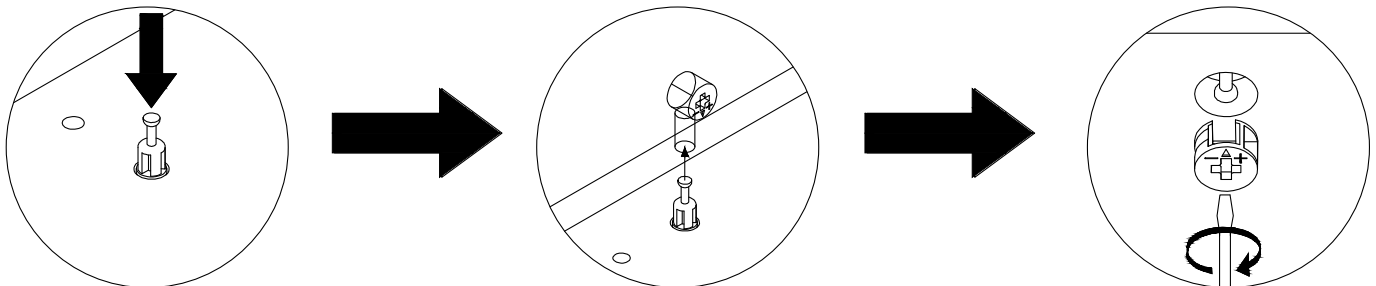

STEP 1 - PUSH CAM BOLT INTO INSERT.

STEP 2 - ALIGN THE CAM BOLT WITH THE HOLE AND PUSH TOGETHER UNTIL FLUSH. (MAKE SURE THE ARROW OF THE CAM LOCK IS POINTING TOWARD THE EDGE OF THE PANEL.)

STEP 3 - THE HEAD OF THE BOLT GOES INTO THE WIDE MOUTH OF THE CAM LOCK. YOU THEN TURN THE LOCK SO THE NARROW PART CLOSSES OVER THE BOLT.

STEP 1

PARTS REQUIRED

1 - SMALL CENTRE PANEL x1

2 - SHELF PANEL - RIGHT x1

HARDWARE REQUIRED

A  08

B  06

TOOLS REQUIRED

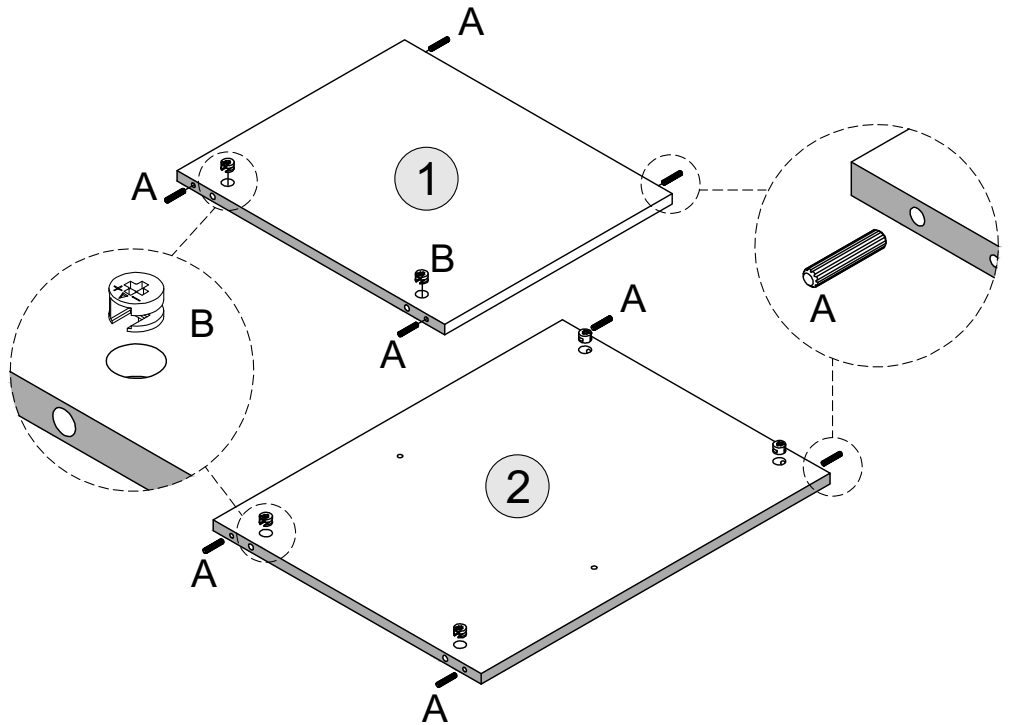
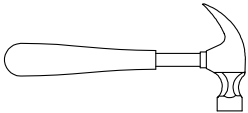

STEP 2

PARTS REQUIRED

3 - LARGE CENTRE PANEL x1

HARDWARE REQUIRED

A  04

B  02

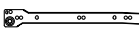
O  02

S  08

TOOLS REQUIRED

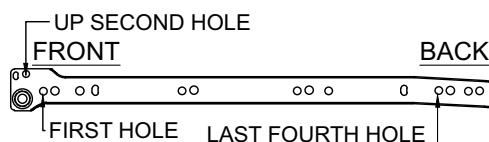
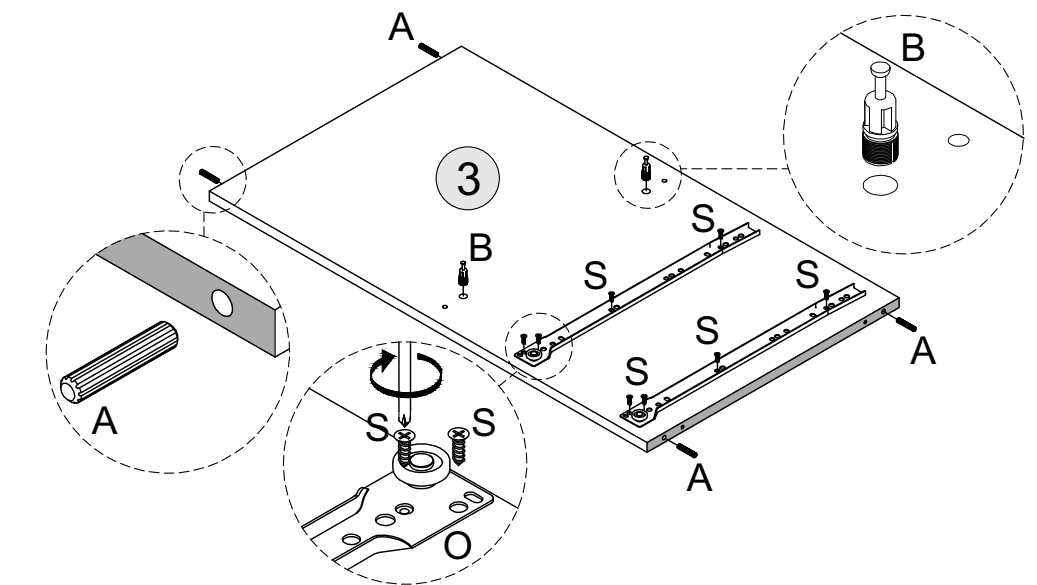
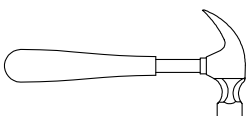
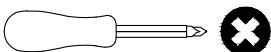

STEP 3

PARTS REQUIRED

3 - LARGE CENTRE PANEL x1

HARDWARE REQUIRED

B  02

D  01

L  02

M  01

TOOLS REQUIRED

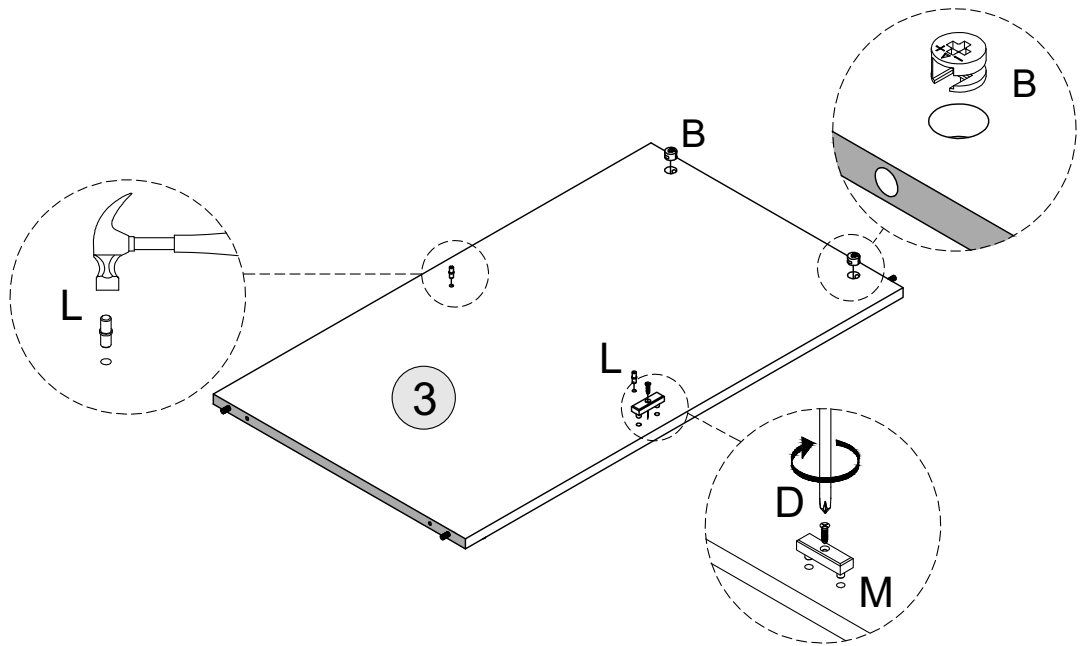
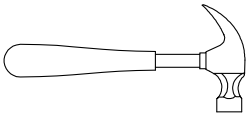
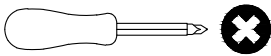

STEP 4

PARTS REQUIRED

4 - SIDE PANEL - RIGHT x1

HARDWARE REQUIRED

A  04

B  02

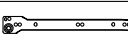
O  02

S  08

TOOLS REQUIRED

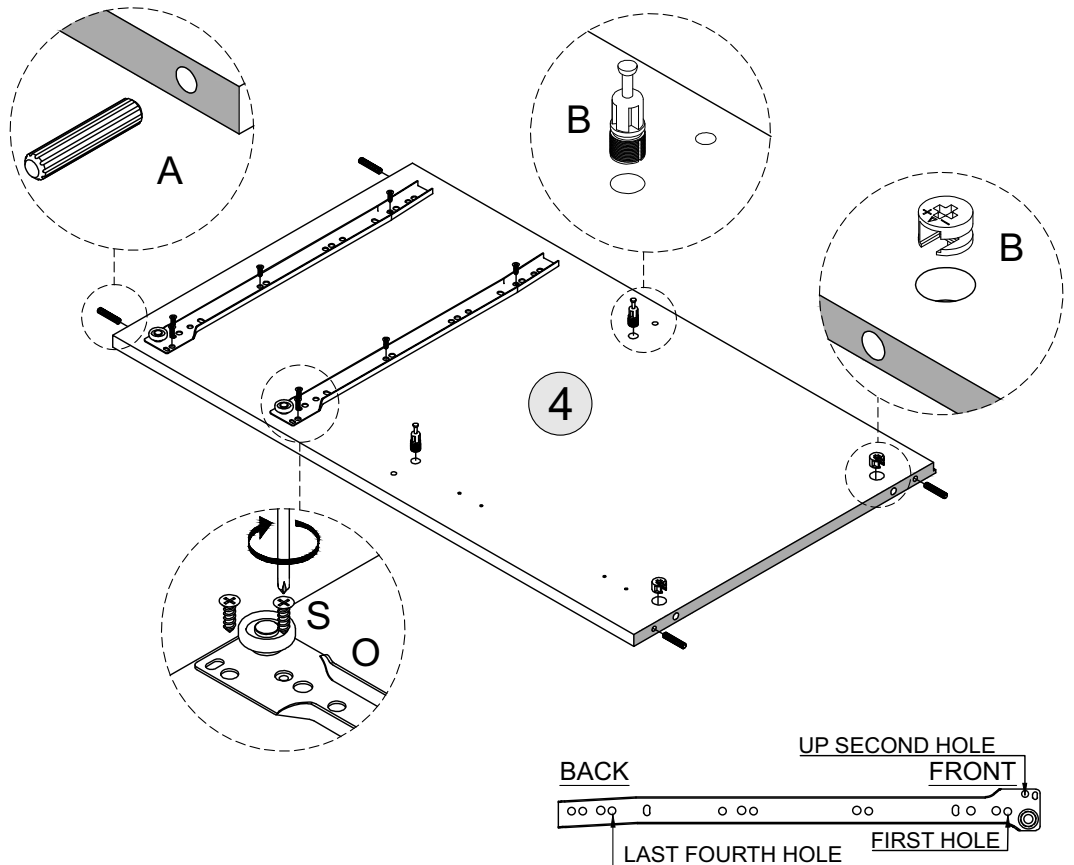
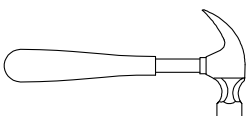
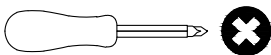

STEP 5

PARTS REQUIRED

5 - SIDE PANEL - LEFT x1

HARDWARE REQUIRED

A  04

B  02

L  02

TOOLS REQUIRED

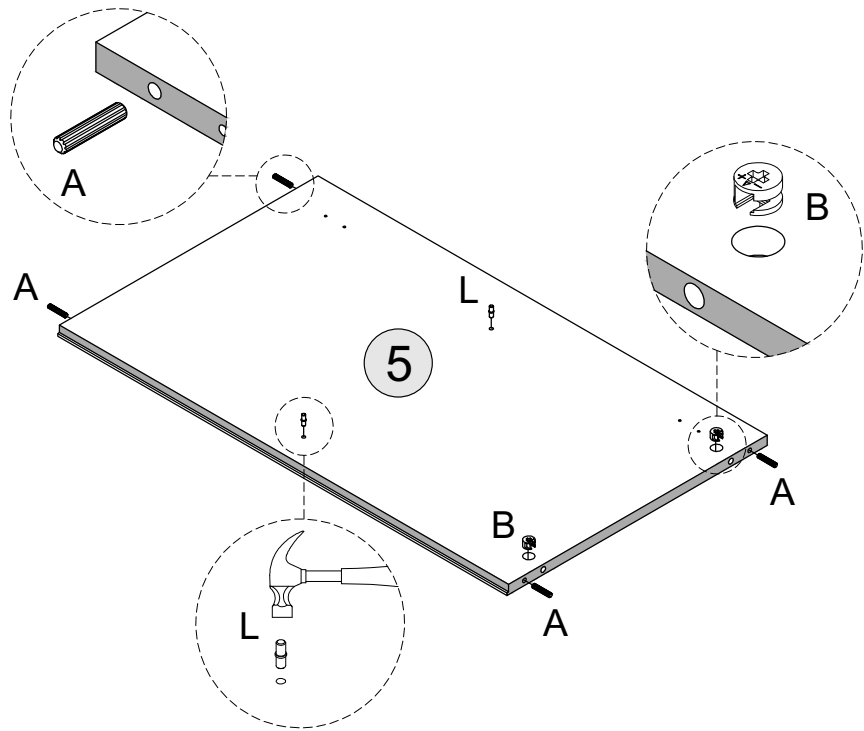
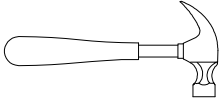

STEP 6

PARTS REQUIRED

6 - TOP PANEL x1

HARDWARE REQUIRED

B  08

D  01

M  01

TOOLS REQUIRED

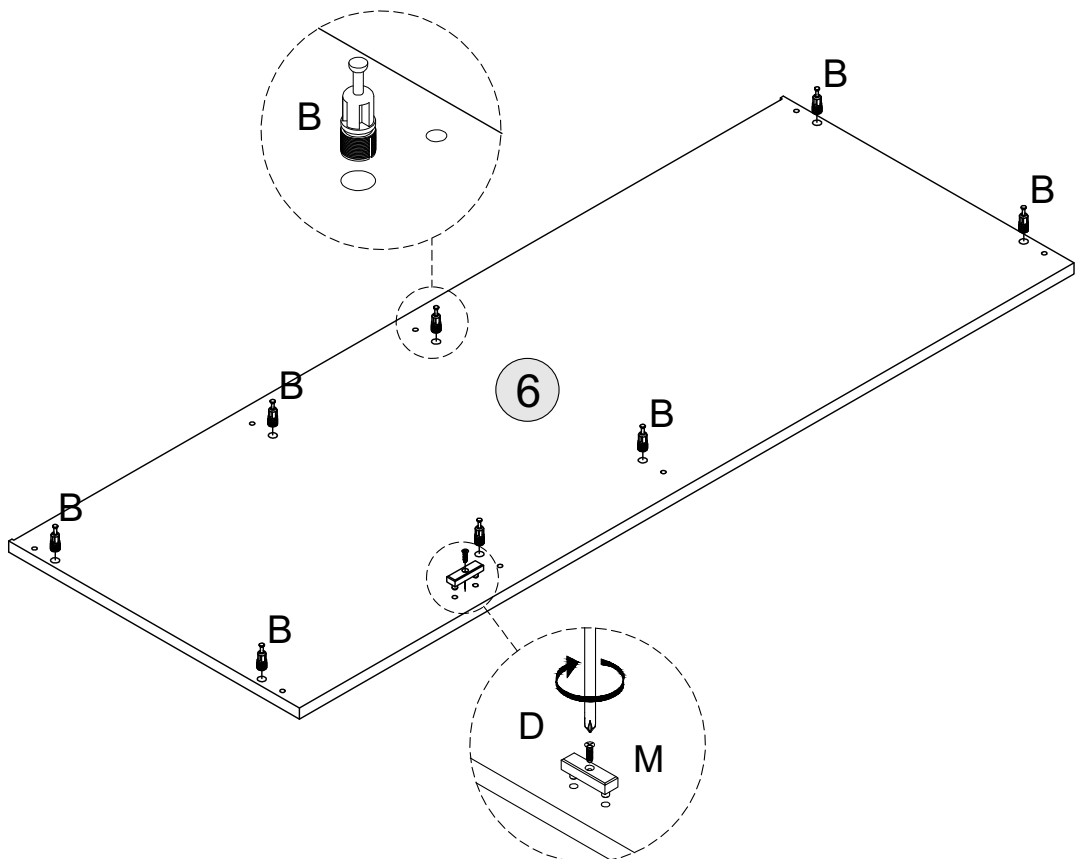
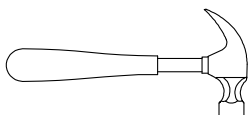
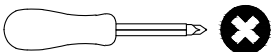

STEP 7

PARTS REQUIRED

1 - SMALL CENTRE PANEL x1

2 - SHELF PANEL - RIGHT x1

HARDWARE REQUIRED

C  02

TOOLS REQUIRED

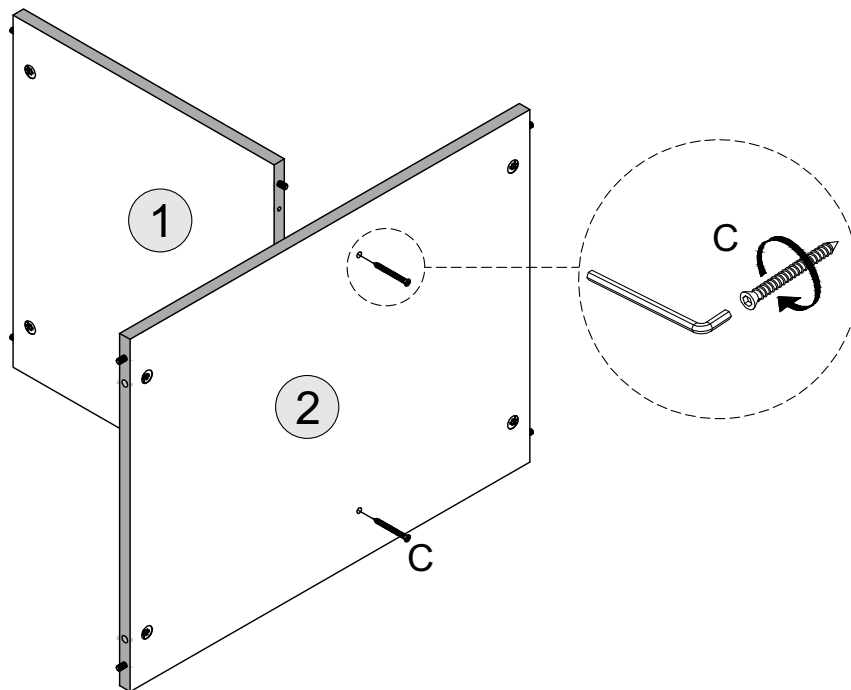
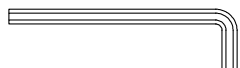

STEP 8

PARTS REQUIRED

3 - LARGE CENTRE PANEL x1

4 - SIDE PANEL - RIGHT x1

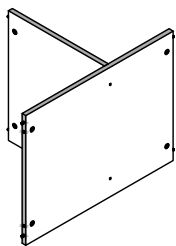

HARDWARE REQUIRED

TOOLS REQUIRED

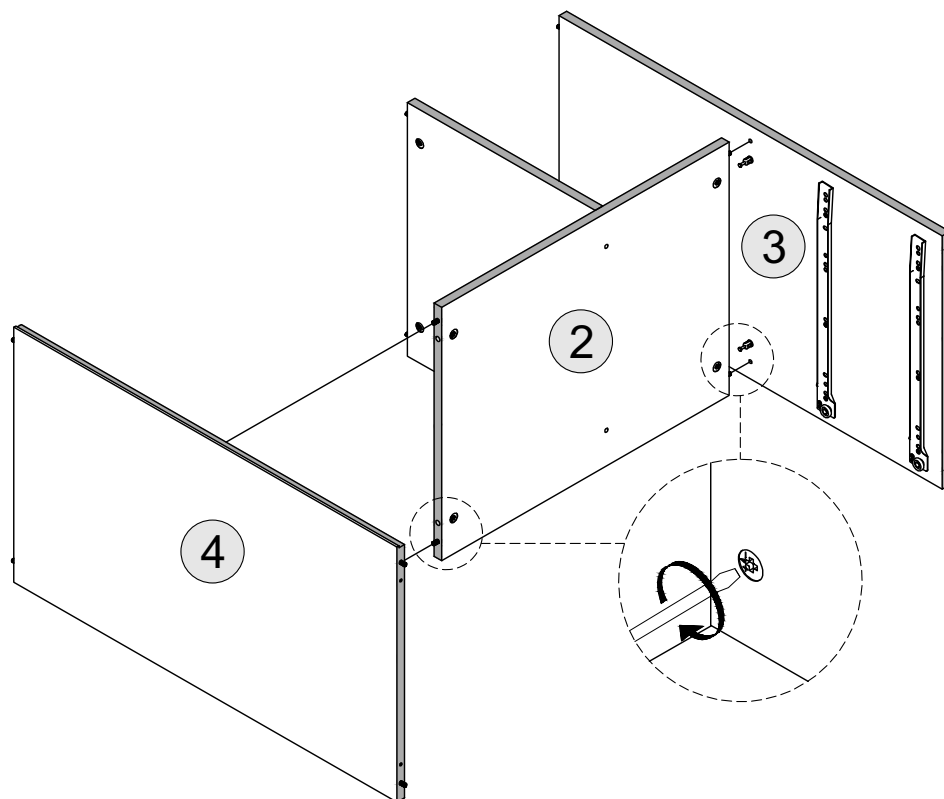
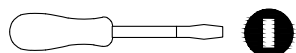

STEP 9

PARTS REQUIRED

5 - SIDE PANEL - LEFT x1

6 - TOP PANEL x1

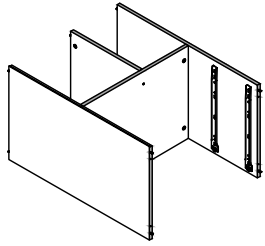

HARDWARE REQUIRED

TOOLS REQUIRED

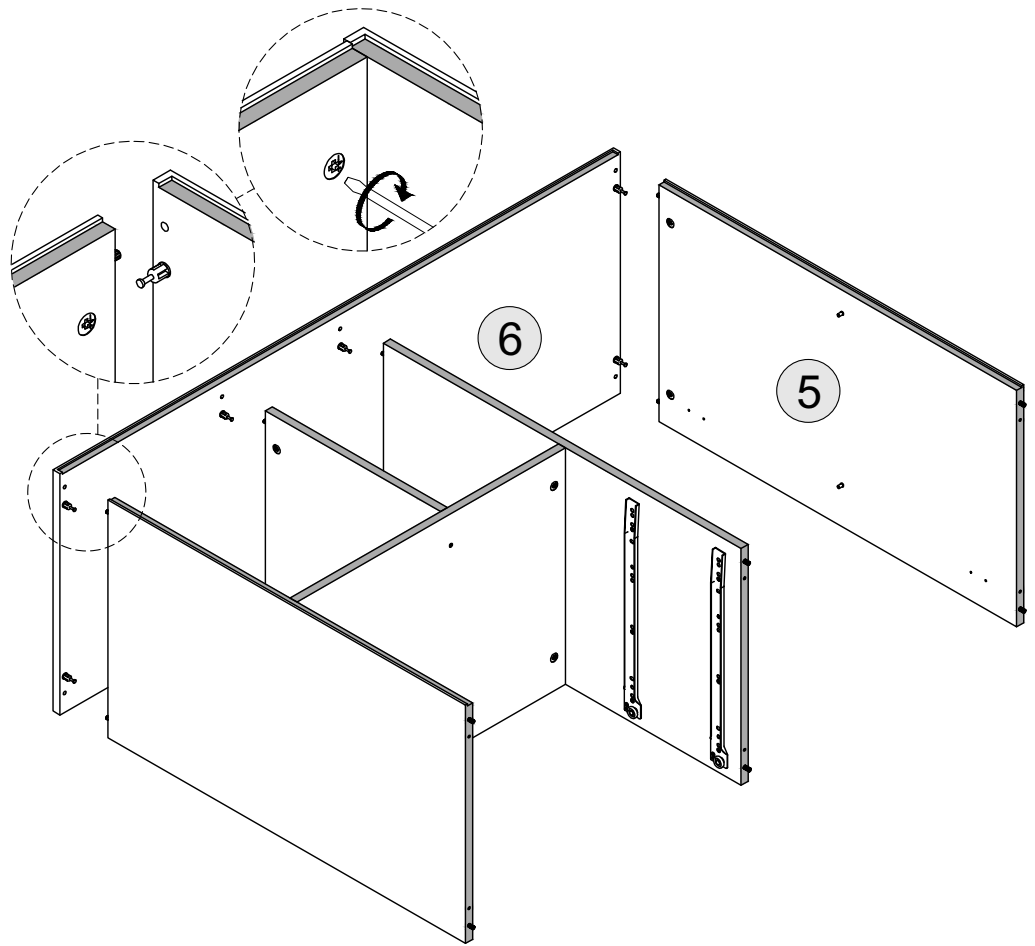
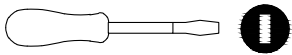

STEP 10

PARTS REQUIRED

7 - BOTTOM PANEL x1

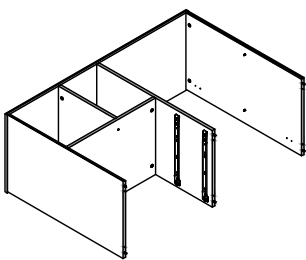

HARDWARE REQUIRED

C  06

TOOLS REQUIRED

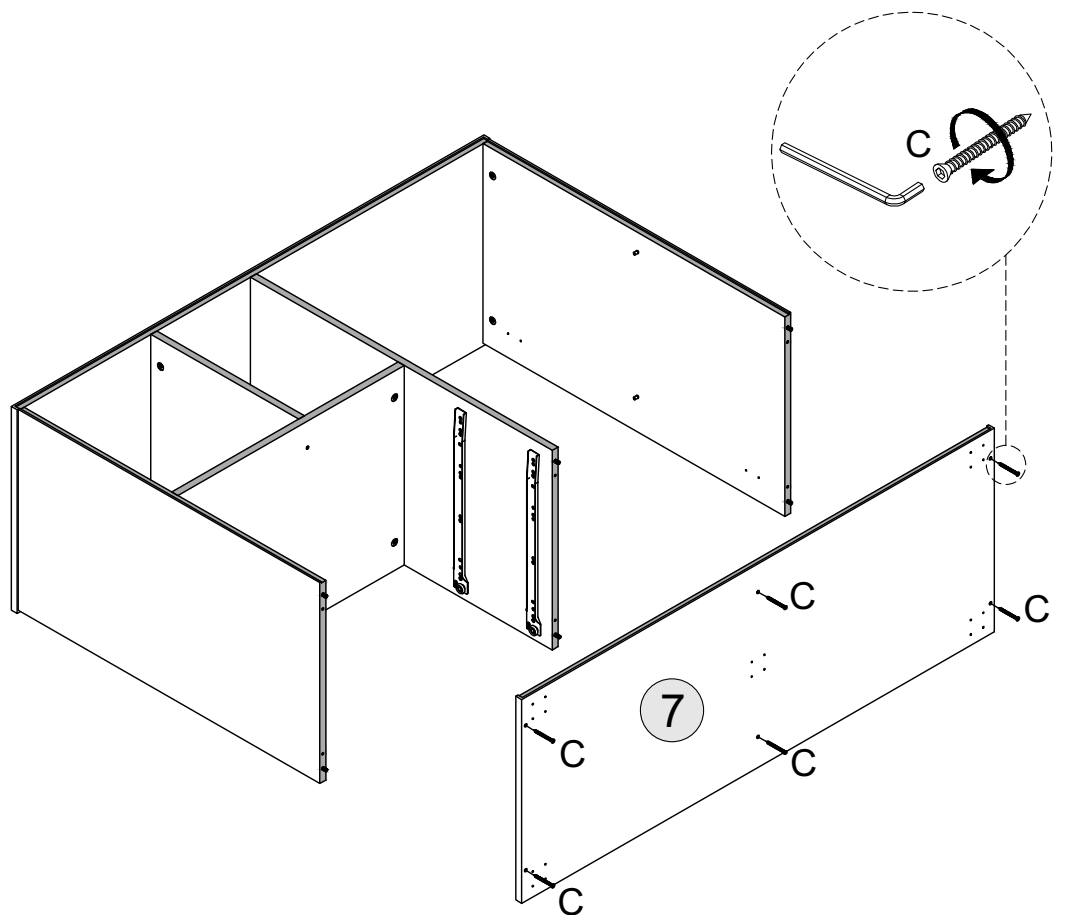

STEP 11

PARTS REQUIRED

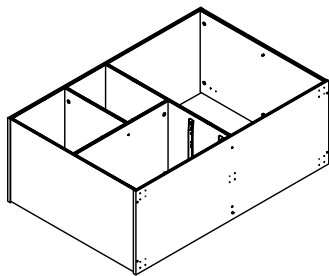

HARDWARE REQUIRED

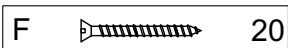

TOOLS REQUIRED

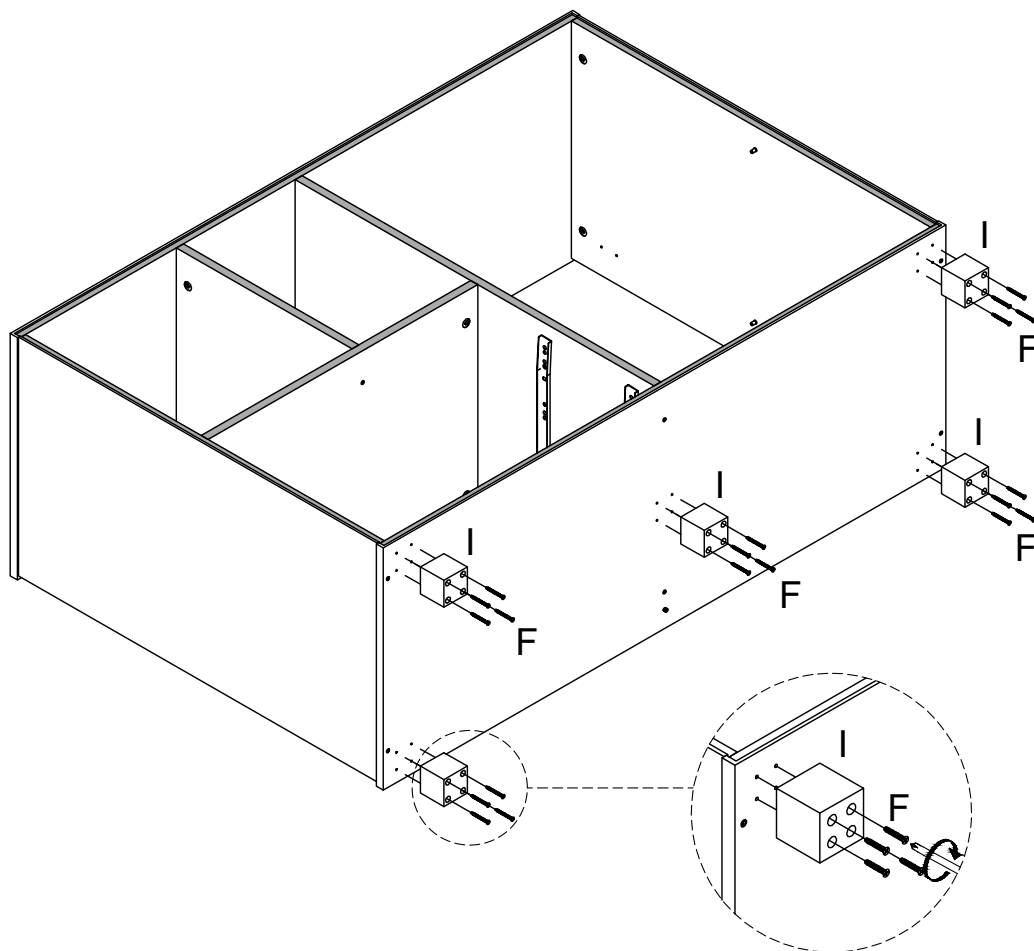
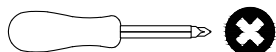

STEP 12

PARTS REQUIRED

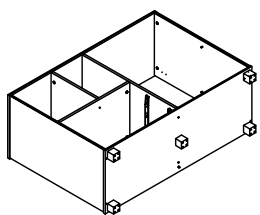

HARDWARE REQUIRED

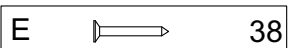

TOOLS REQUIRED

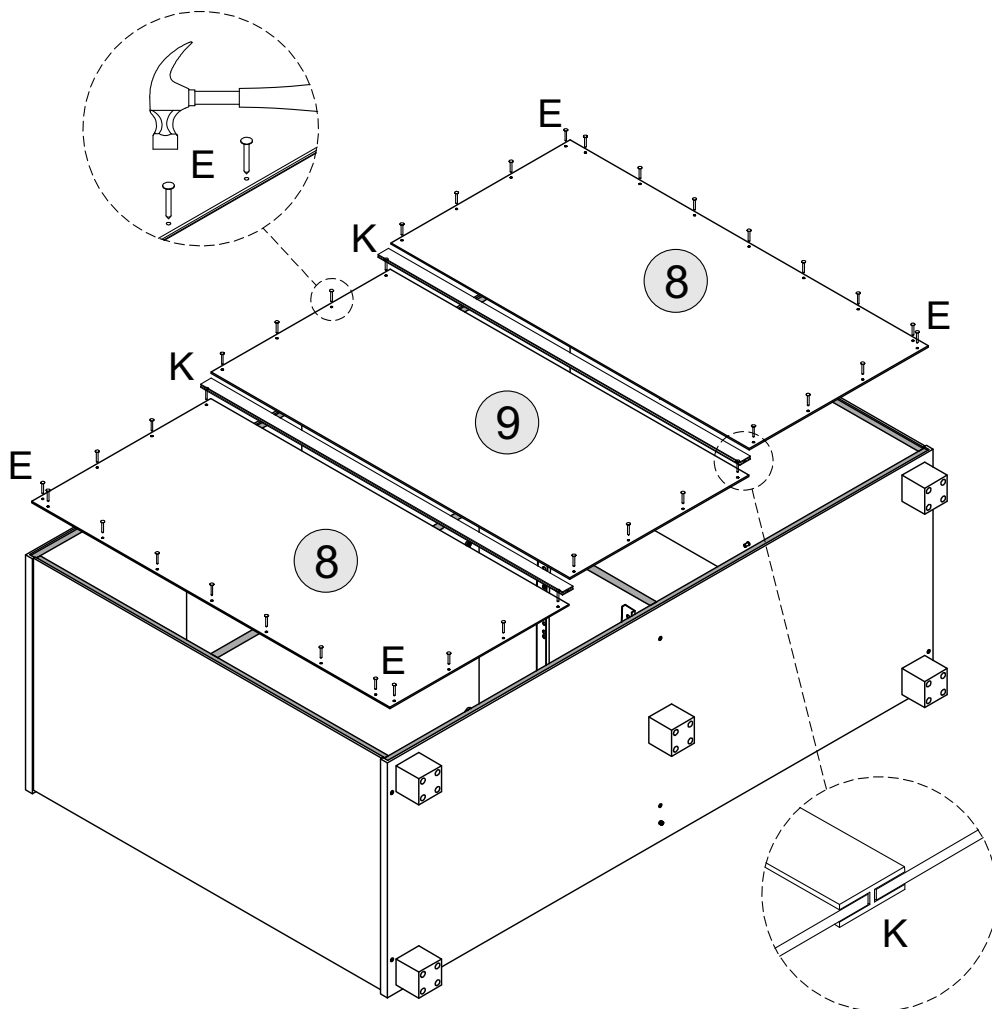
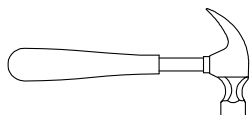



STEP 13

PARTS REQUIRED

10 - DRAWER BACK	x2
11 - DRAWER SIDE-LEFT	x2
12 - DRAWER SIDE-RIGHT	x2
13 - DRAWER FRONT	x2

HARDWARE REQUIRED

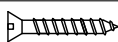
A		16
B		06
B		04
T		04

TOOLS REQUIRED

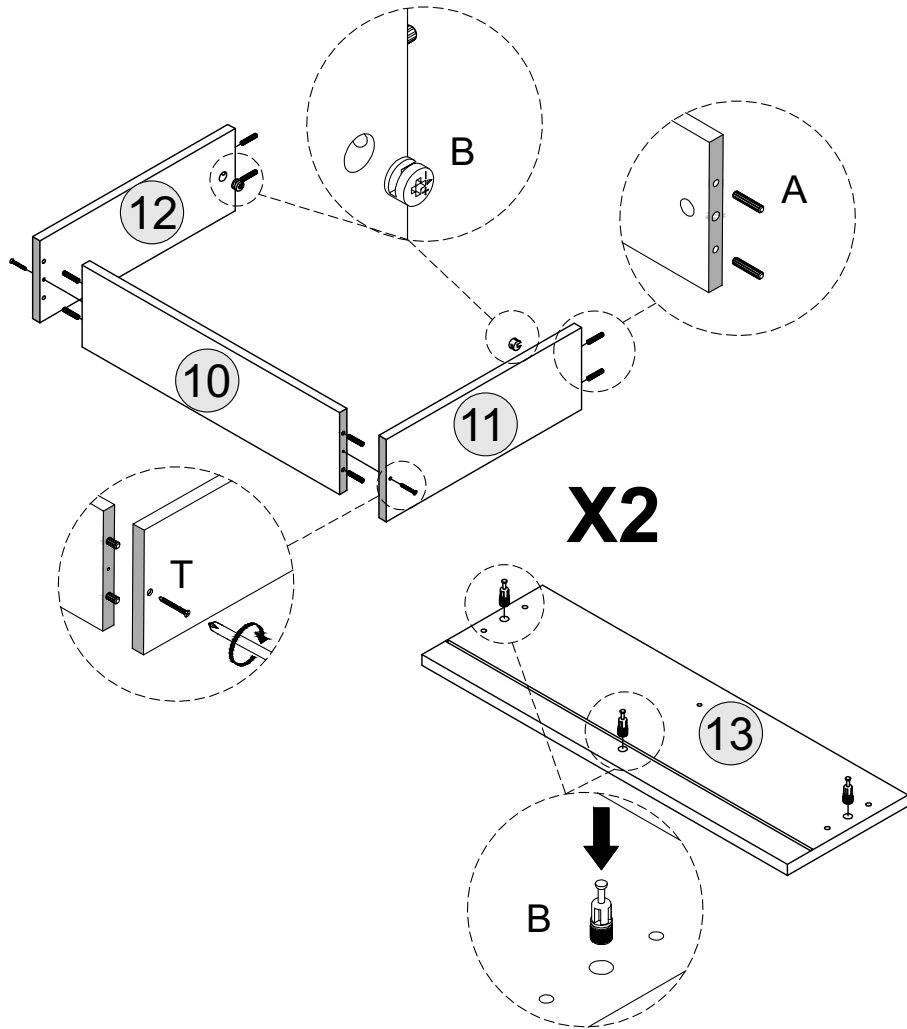
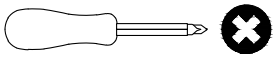



STEP 14

PARTS REQUIRED

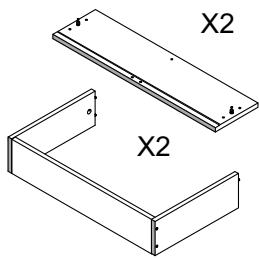
14 - DRAWER BASE	x2
------------------	----



HARDWARE REQUIRED

G		02
R		02
S		12

TOOLS REQUIRED

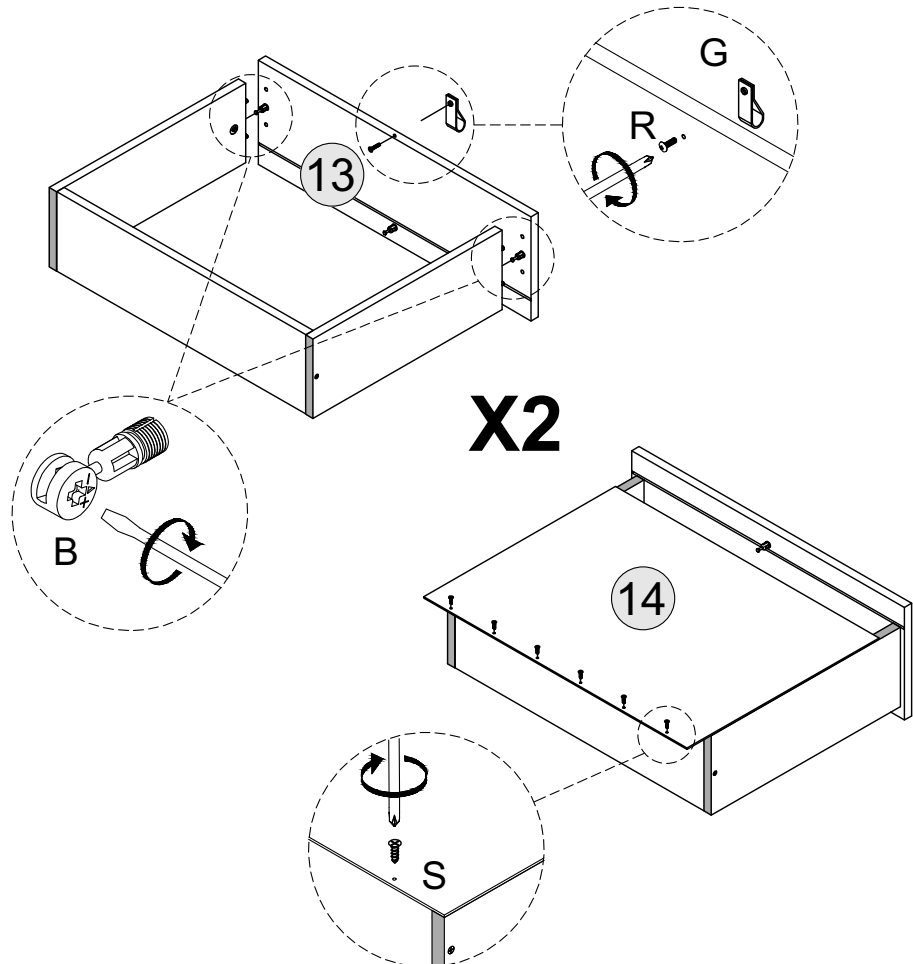
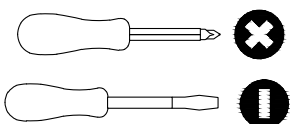

STEP 15

PARTS REQUIRED

15 -DRAWER BOTTOM SUPPORT RAIL X2

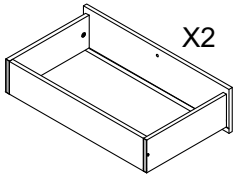

HARDWARE REQUIRED

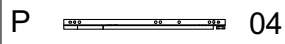
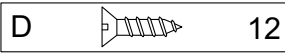

TOOLS REQUIRED

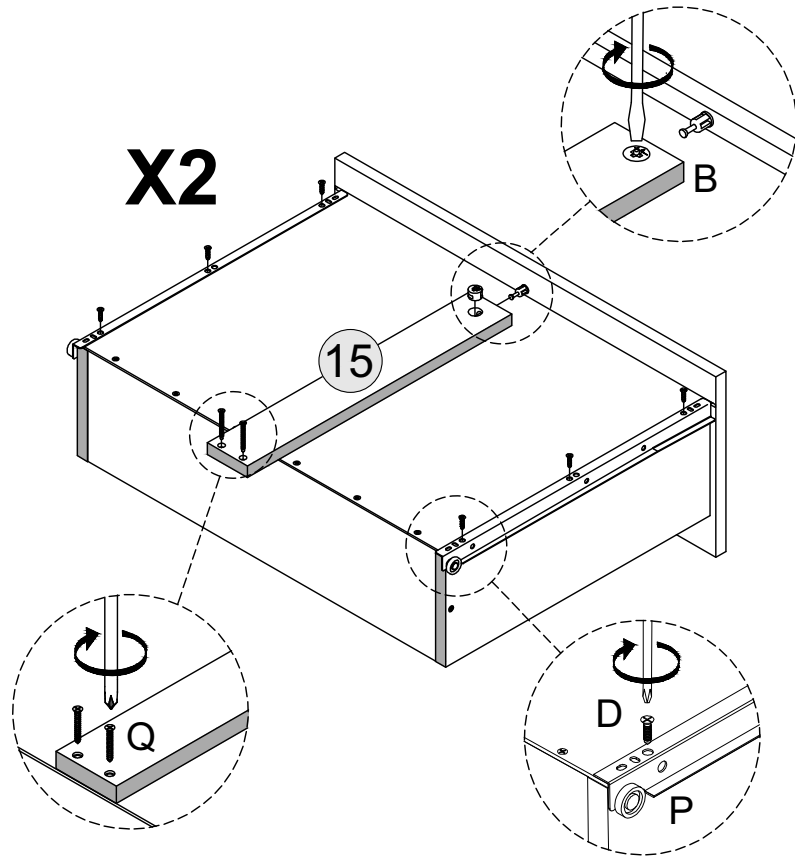
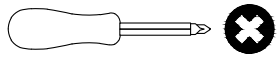

STEP 16

PARTS REQUIRED

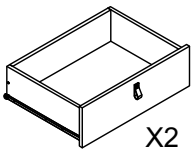
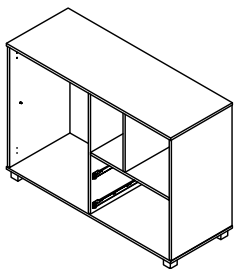

HARDWARE REQUIRED

TOOLS REQUIRED

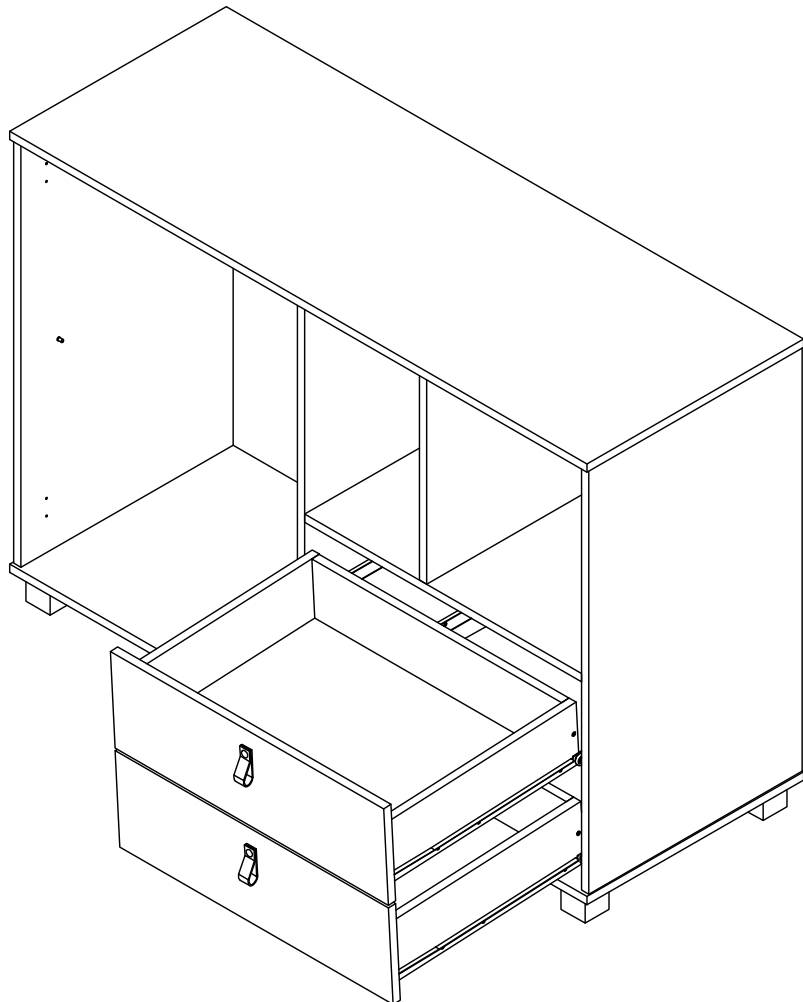

STEP 17

PARTS REQUIRED

16 - LARGE DOOR x1

17 - SMALL DOOR x1

HARDWARE REQUIRED

D  08

N  04

TOOLS REQUIRED

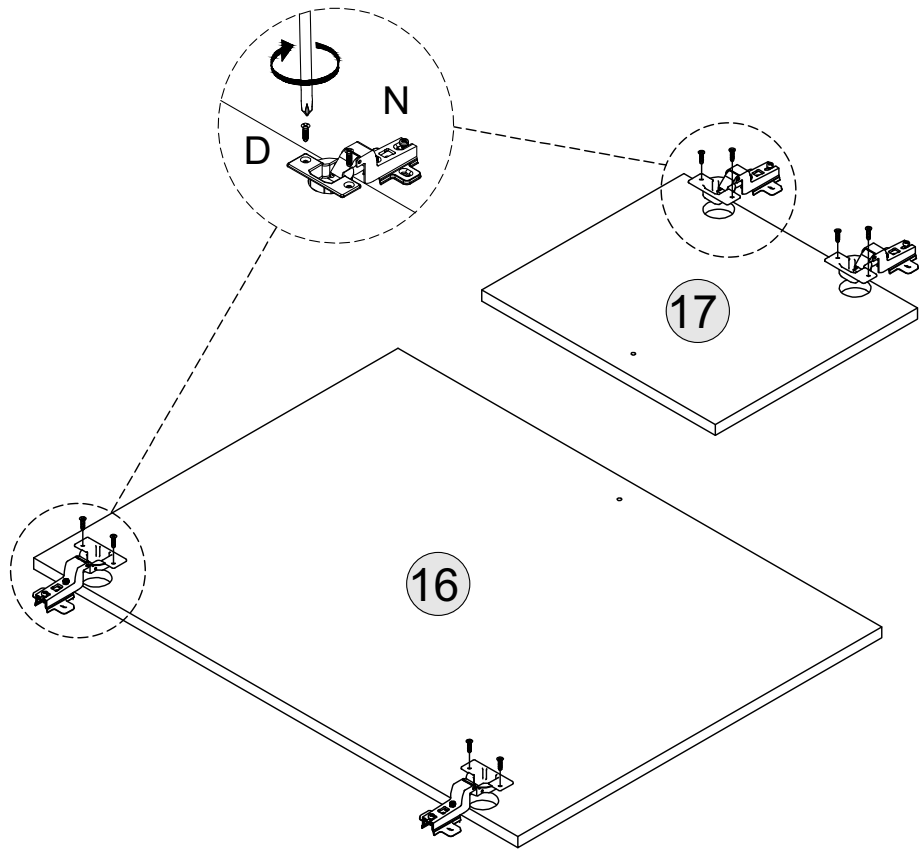
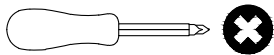

STEP 18

PARTS REQUIRED

16 - LARGE DOOR x1

17 - SMALL DOOR x1

18 - SHELF PANEL - LEFT x1

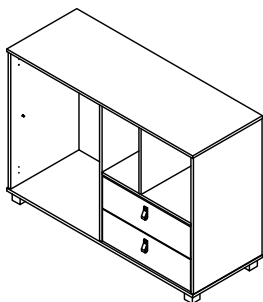

HARDWARE REQUIRED

H  08

G  02

R  02

TOOLS REQUIRED

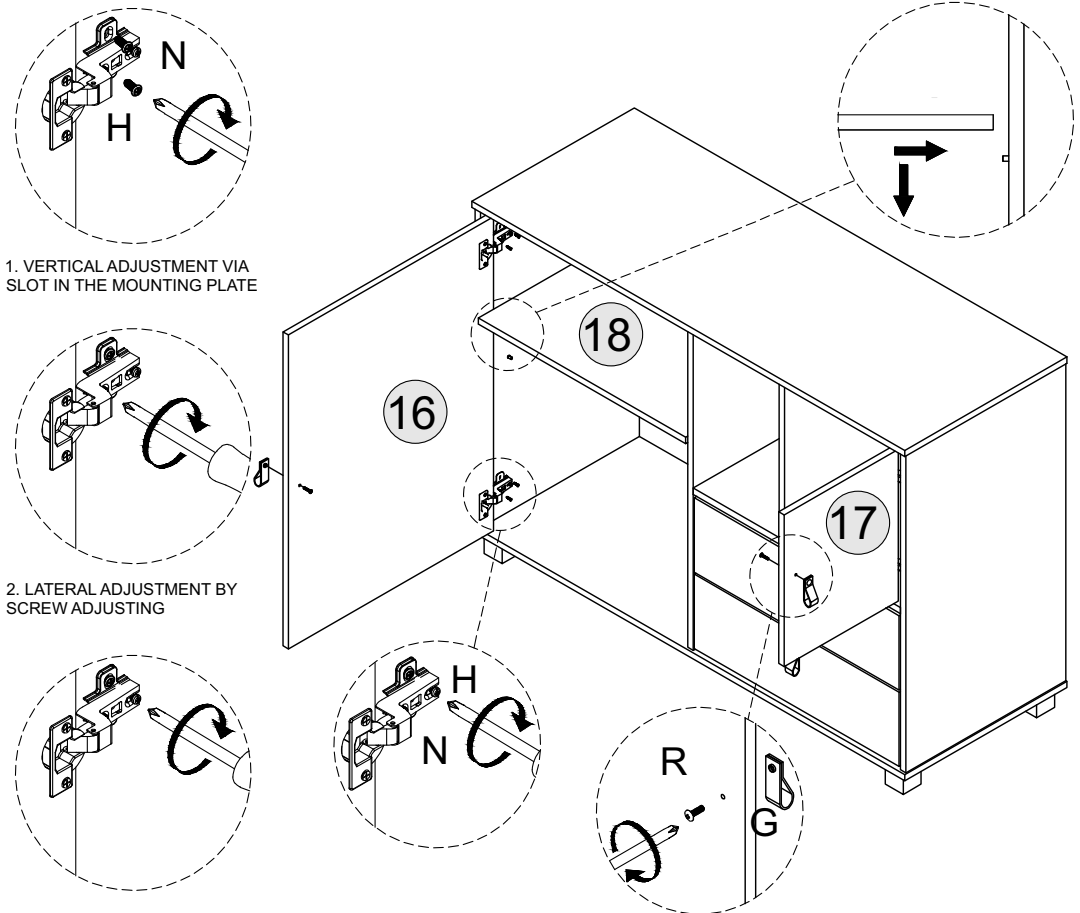
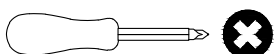

1. VERTICAL ADJUSTMENT VIA SLOT IN THE MOUNTING PLATE

2. LATERAL ADJUSTMENT BY SCREW ADJUSTING

3. FRONT-TO-BACK BY THE SLACKING THE HINGE ARM MOUNTING SCREW

YOU SHOULD RE-ADJUST SCREWS AS SHOWN TO ALIGN DOOR ONCE HINGES HAVE BEEN ATTACHED.

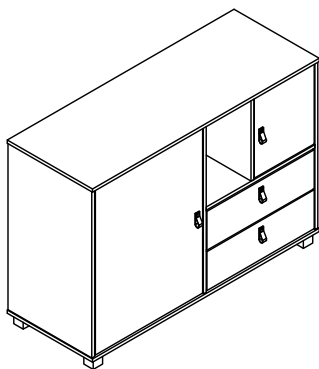
STEP 19PART REQUIREDHARDWARE REQUIRED

U		02
---	---	----

V		02
---	---	----

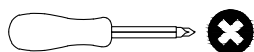
TOOLS REQUIRED**WARNING**

Serious or fatal injuries can occur from furniture tipping over. To prevent the furniture from tipping over we recommend that it is permanently fixed to the wall.

Wall fixings are not supplied with this product as different wall materials require different types of fixing devices. Please make sure you use fixings suitable for the walls in your home.

