

# FELIX 2 DOOR WARDROBE ASSEMBLY INSTRUCTIONS

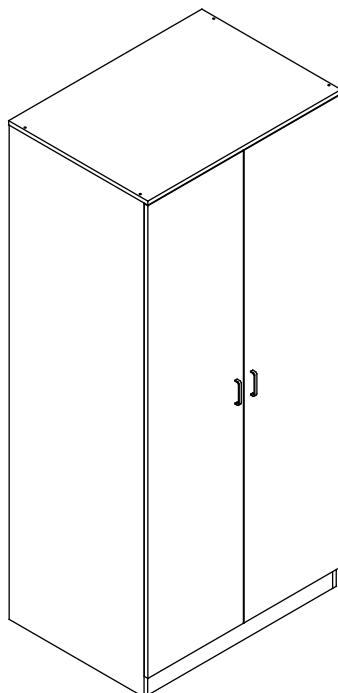

FOR DOMESTIC USE ONLY  
IMPORTANT

PLEASE READ BEFORE YOU CONTINUE FURTHER

THE PRODUCT YOU HAVE PURCHASED WILL GIVE YOU MANY YEARS OF SERVICE IF YOU FOLLOW THE GUIDELINES FOR ITS SAFE ASSEMBLY AND PERIODIC MAINTENANCE AND CLEANING  
ASSEMBLE ON A SOFT CLEAN SURFACE

DO NOT USE ANY TOOLS OTHER THAN THOSE SHOWN

ANY SPANNERS OR ALLEN KEYS REQUIRED ARE INCLUDED WITH THE FITTING KIT.

DO NOT FOR ANY REASON USE A POWER TOOL TO ASSEMBLE THIS PRODUCT. ITS USE WILL INVALIDATE ANY CLAIM YOU MAY HAVE AND COULD MAKE THIS PRODUCT UNSAFE.

DEPENDING ON THE AMOUNT OF USE THIS PRODUCT RECEIVES, IT MAY BE NECESSARY TO TIGHTEN UP THE FIXINGS FROM TIME TO TIME. THIS IS COMPLETELY NORMAL FOR ANY FLAT PACK FURNITURE. DO NOT OVERTIGHTEN FIXINGS.





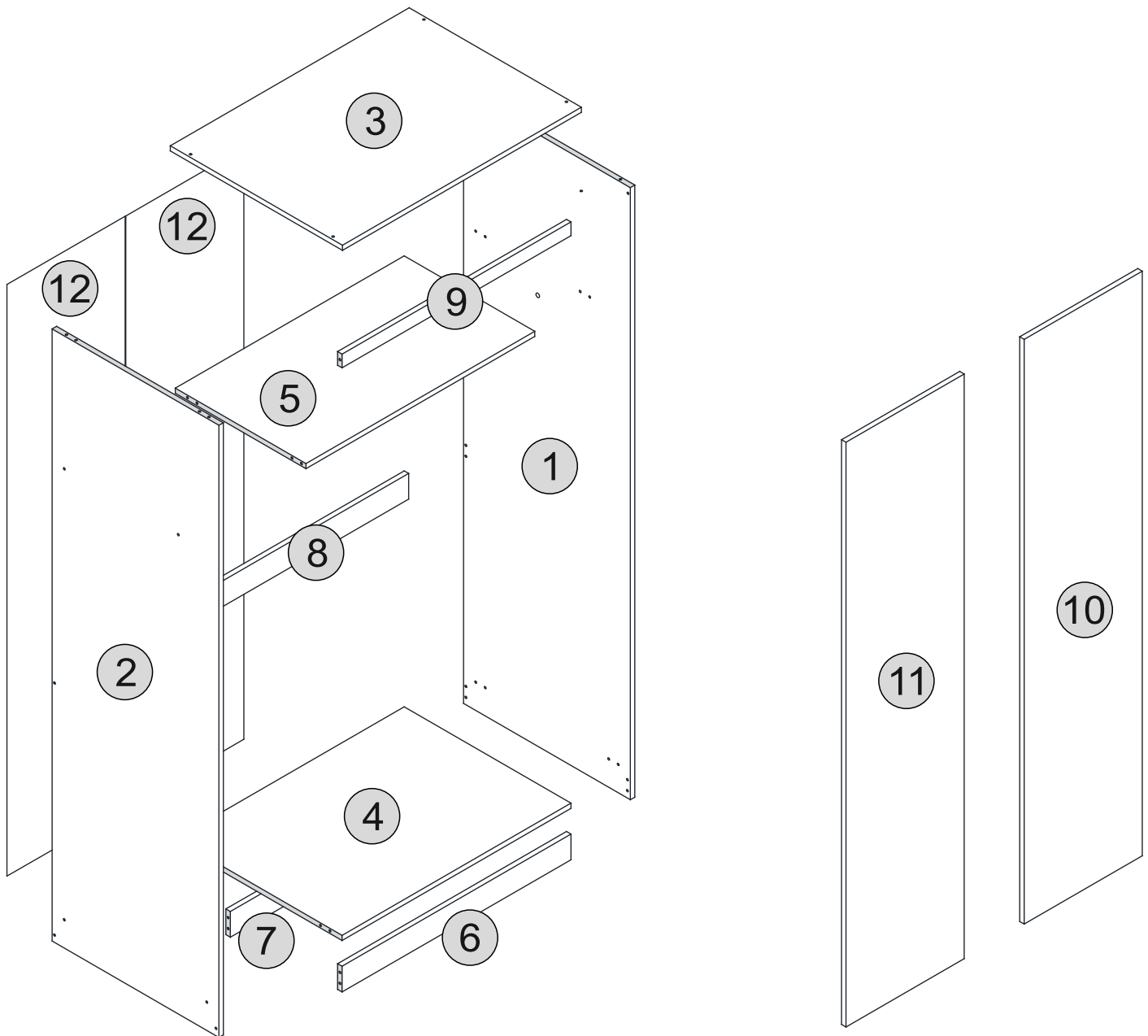





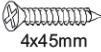

FOR CLEANING, YOU MAY USE A DAMP CLOTH (NOT WET). DO NOT USE POLISH, DETERGENT OR CHEMICAL CLEANERS.

THE SURFACE OF THIS ITEM IS NOT HEAT RESISTANT. ALWAYS USE A PLACE MAT UNDER HOT OR COLD ITEMS TO PREVENT MARKING.



Part Number	Part Code	Part Description	Quantity	Carton
1	S100-101-162-TA1-01	Right Side Panel	1	1/2
2	S100-101-162-TA1-02	Left Side Panel	1	1/2
3	S100-101-162-TA1-03	Top Panel	1	2/2
4	S100-101-162-TA1-04	Base	1	1/2
5	S100-101-162-TA1-05	Shelf	1	2/2
6	S100-101-162-TA1-06	Lower Front Crossbar	1	1/2
7	S100-101-162-TA1-07	Lower Back Crossbar	1	1/2
8	S100-101-162-TA1-08	Middle Back Crossbar	1	2/2
9	S100-101-162-TA1-09	Top Front Crossbar	1	2/2
10	S100-101-162-TA1-10	Right Door	1	2/2
11	S100-101-162-TA1-11	Left Door	1	2/2
12	S100-101-162-TA1-12	Back Panel	2	1/2

# HARDWARE LIST

No.	Part Name		Qty
A	Wooden Dowel (6x25mm)		20
B	45mm Screw (4x45mm)		18
C	14mm Screw (3.5x14mm)		40
D	Hanging Rail (765mm)		1
E	5" Hinge		6
F	Hanging Rail Support		2
G	Handle (AL96mm)		2
H	Handle Screw		4
I	PVC L-Bracket		2
J	Plastic Foot		4
K	Nail		46
L	Screw Cover (Sticker 15mm)		14
M	Wall Fixings (4x20mm=1pc)		1

## TIPS FOR FITTING CAM-LOCKS

**WHEN FITTING THE CAM-LOCK**  
ENSURE STARTING POSITION IS CORRECT  
BEFORE YOU INSERT CONNECTING CAM BOLT  
TURN CLOCKWISE UNTIL SECURE

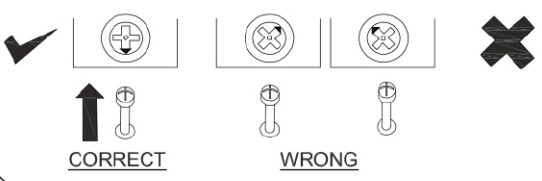

**CORRECT**      **WRONG**

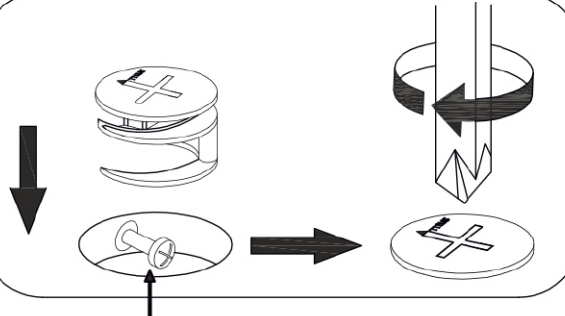

Cam bolt head needs to be in centre

### CAMBOLT

Tighten until shoulder is flush with panel. Do not overtighten or undertighten (see example below)

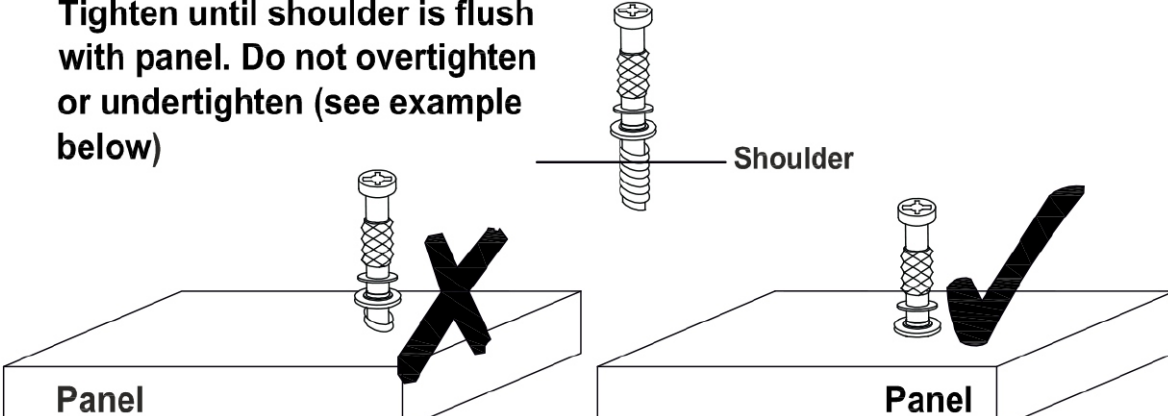

Shoulder

Panel

Panel

# STEP 1

### PARTS REQUIRED

4 - BASE x1

5 - SHELF x1

6 - LOWER FRONT CROSSBAR x1

7 - LOWER BACK CROSSBAR x1

8 - MIDDLE BACK CROSSBAR x1

9 - TOP FRONT CROSSBAR x1

### HARDWARE REQUIRED

A  16

### TOOLS REQUIRED

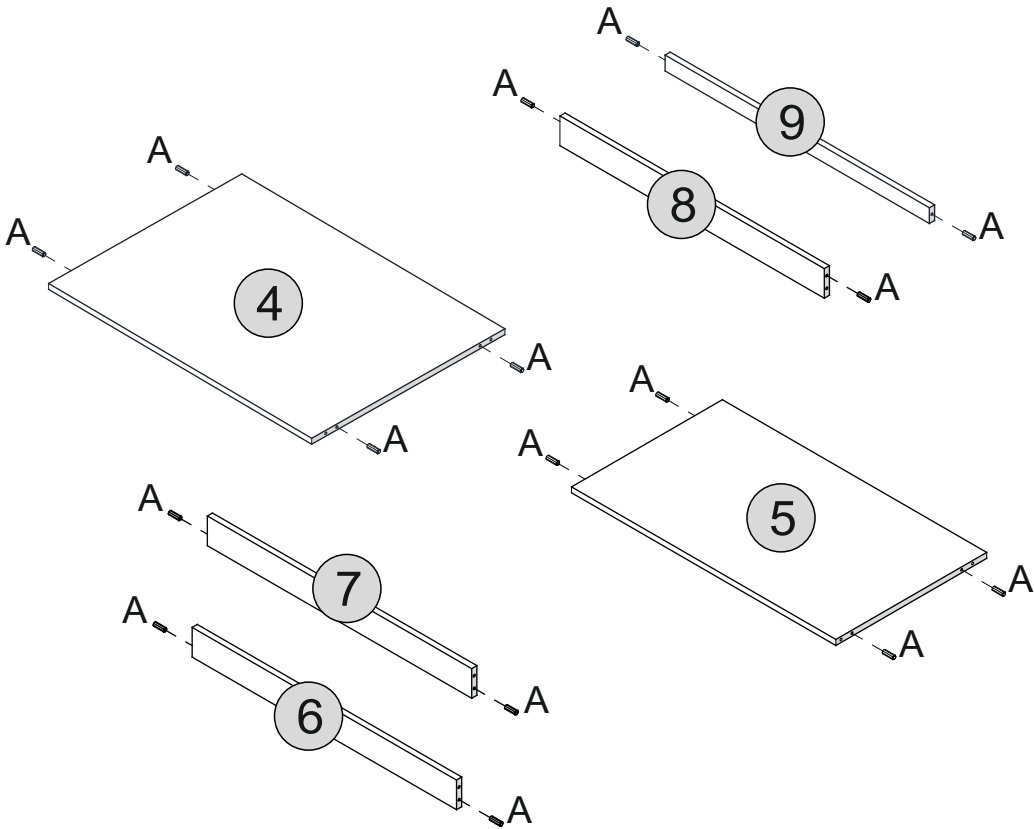
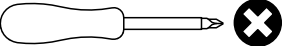

# STEP 2

### PARTS REQUIRED

1 - RIGHT SIDE PANEL x1

2 - LEFT SIDE PANEL x1

### HARDWARE REQUIRED

A  04

C  04

F  02

J  04

### TOOLS REQUIRED

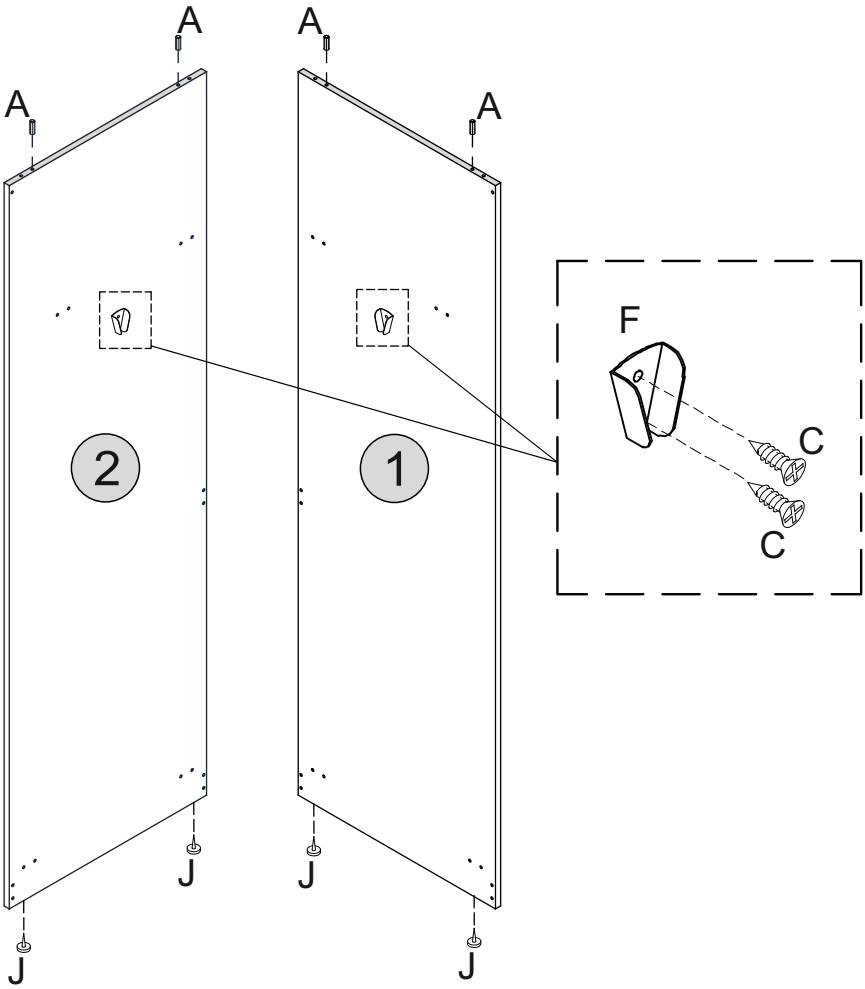
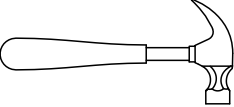
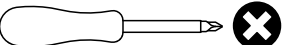



# STEP 3

## PARTS REQUIRED

- 2 - LEFT SIDE PANEL x1
- 4 - BASE x1
- 5 - SHELF x1
- 7 - LOWER BACK CROSSBAR x1
- 8 - MIDDLE BACK CROSSBAR x1

## HARDWARE REQUIRED

- B  06
- L  06

## TOOLS REQUIRED

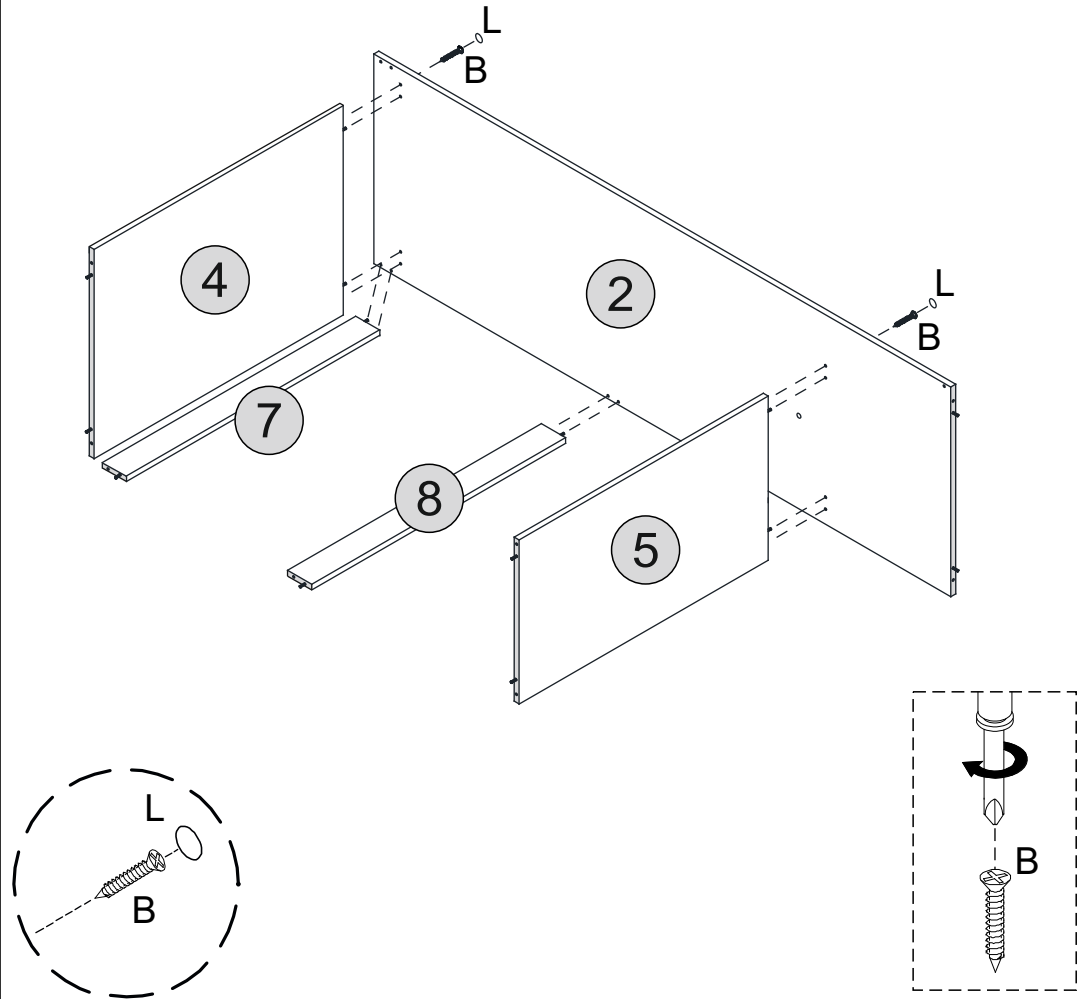
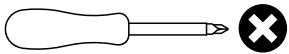



# STEP 4

## PARTS REQUIRED

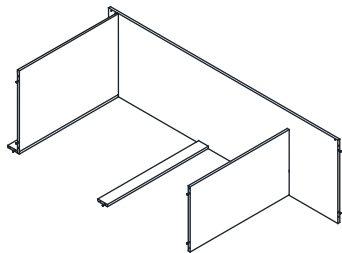
- 1 - RIGHT SIDE PANEL x1
- 6 - LOWER FRONT CROSSBAR x1
- 9 - TOP FRONT CROSSBAR x1



## HARDWARE REQUIRED

- B  08
- L  08

## TOOLS REQUIRED

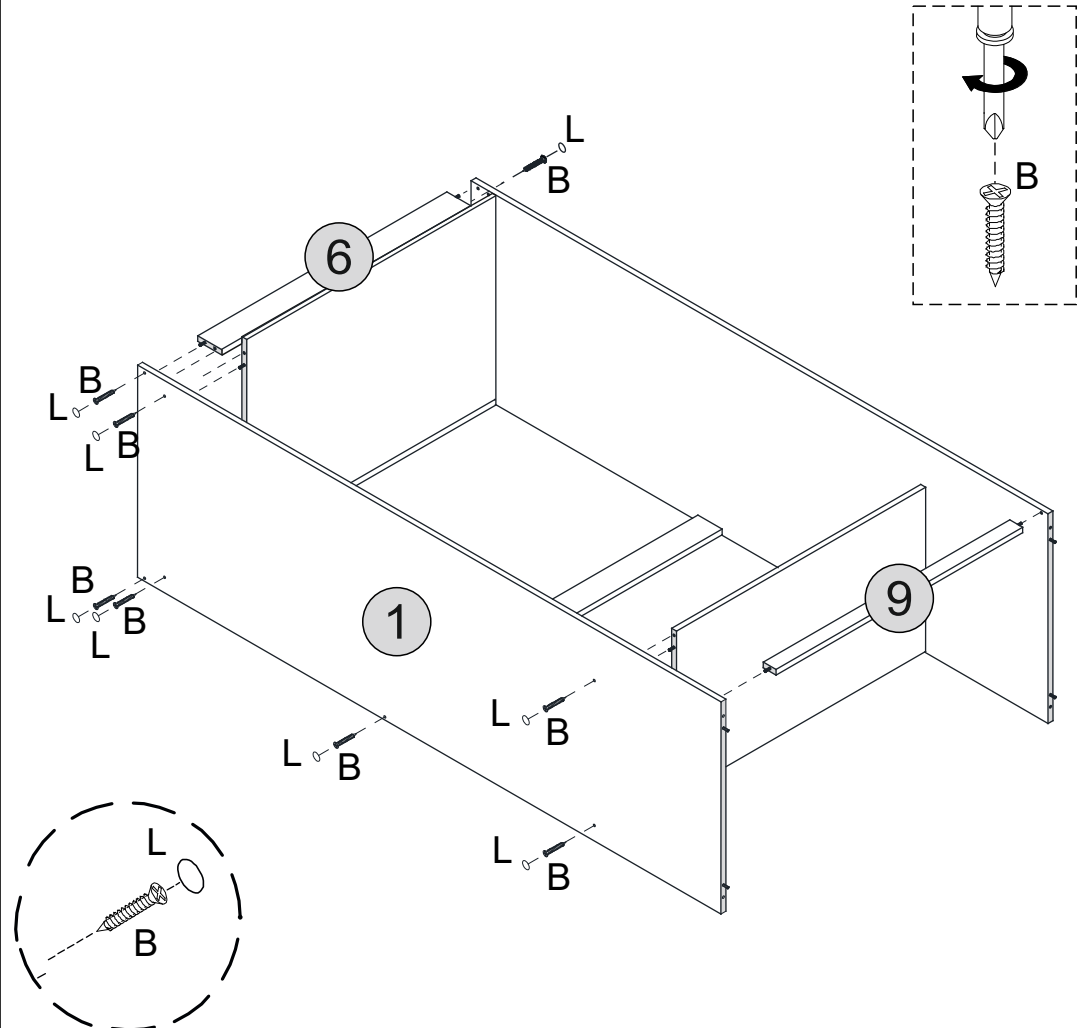
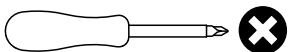

# STEP 5

## PARTS REQUIRED

3 - TOP PANEL x1

## HARDWARE REQUIRED

C  02

I  01

## TOOLS REQUIRED

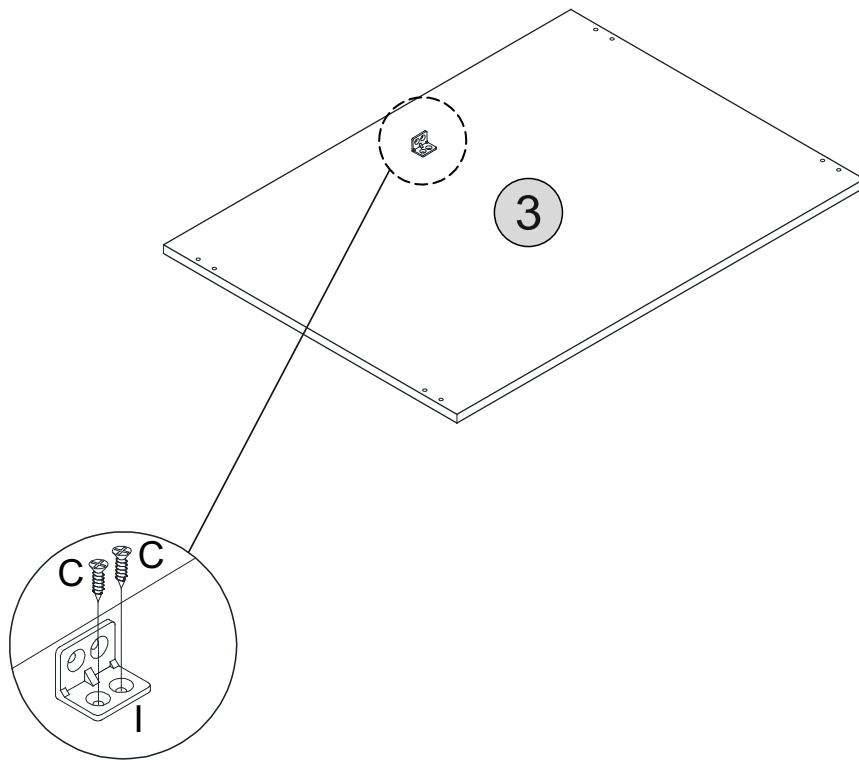
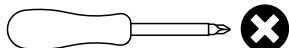

# STEP 6

## PARTS REQUIRED

3 - TOP PANEL x1

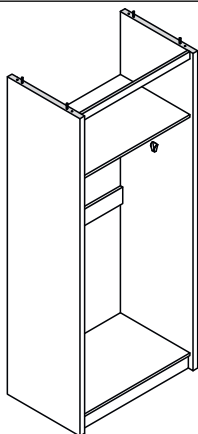

## HARDWARE REQUIRED

B  04

C  06

I  01

## TOOLS REQUIRED

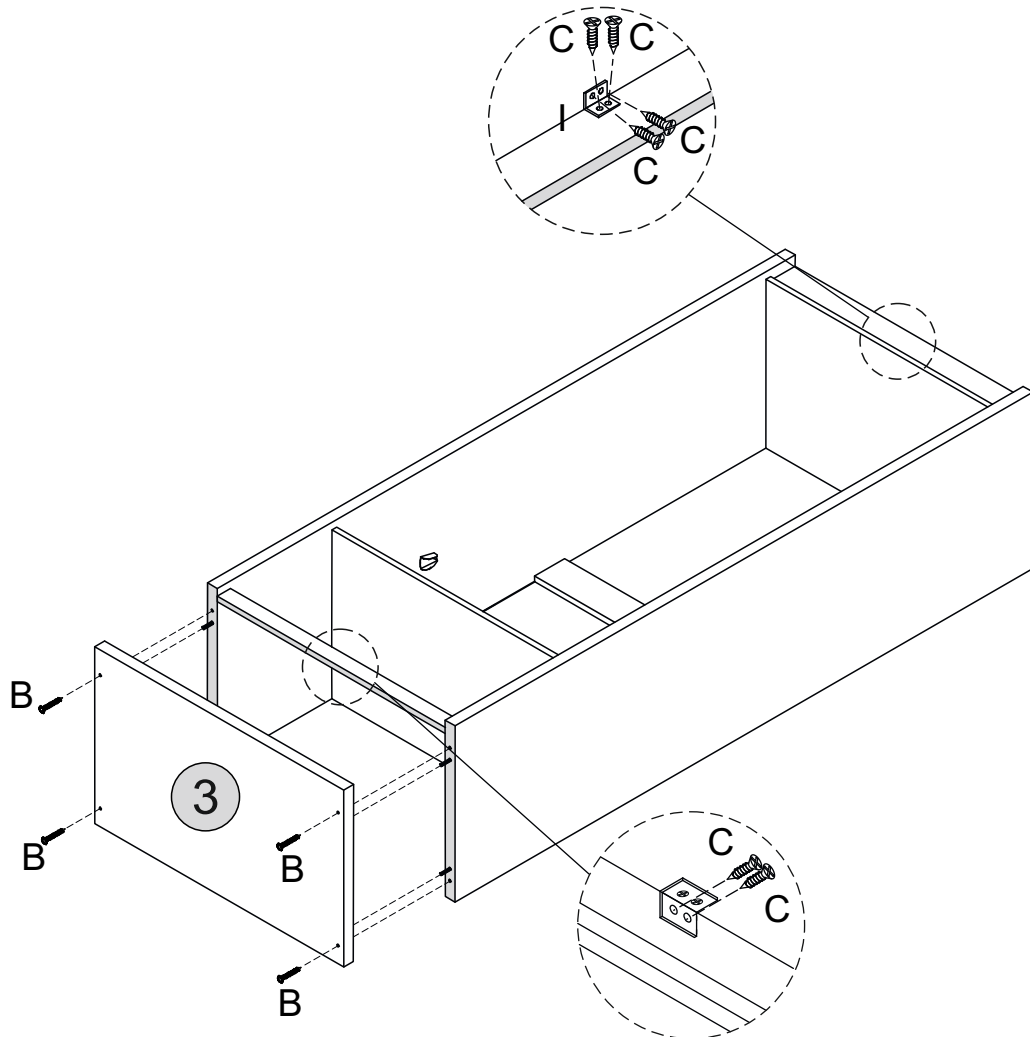
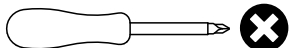

# STEP 7

## PARTS REQUIRED

12 - BACK PANEL x2

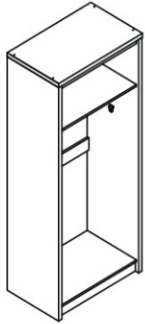

## HARDWARE REQUIRED

C  4

K  46

## TOOLS REQUIRED

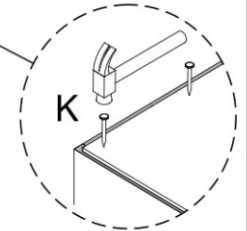
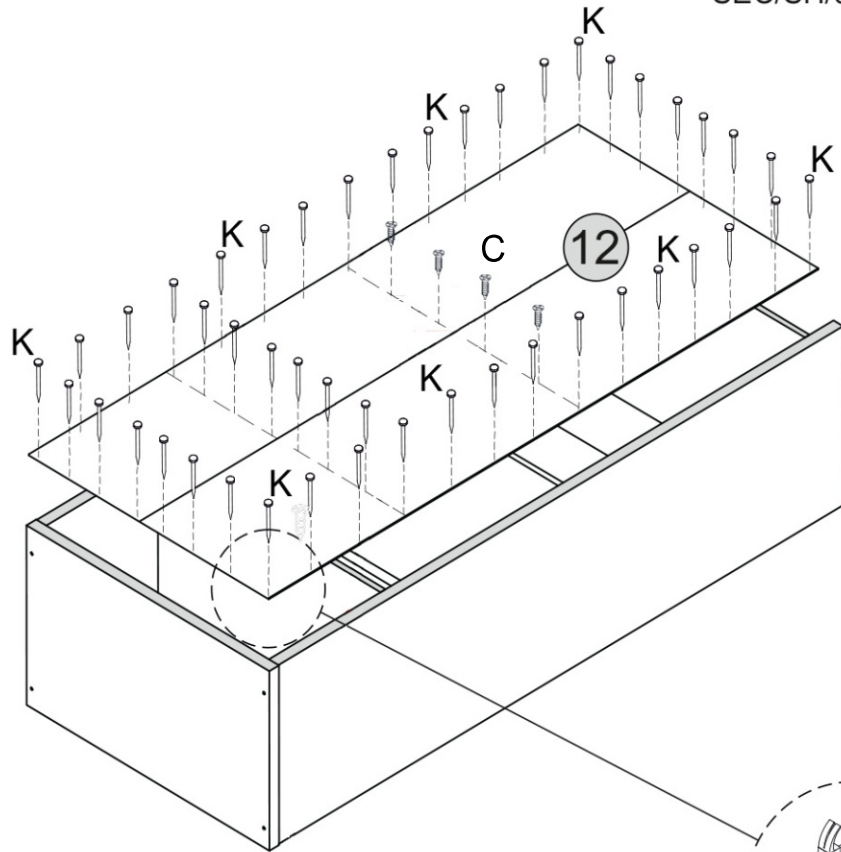
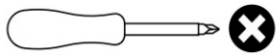

# STEP 8

## PARTS REQUIRED

10 - RIGHT DOOR x1

11 - LEFT DOOR x1

## HARDWARE REQUIRED

C  12

E  06

## TOOLS REQUIRED

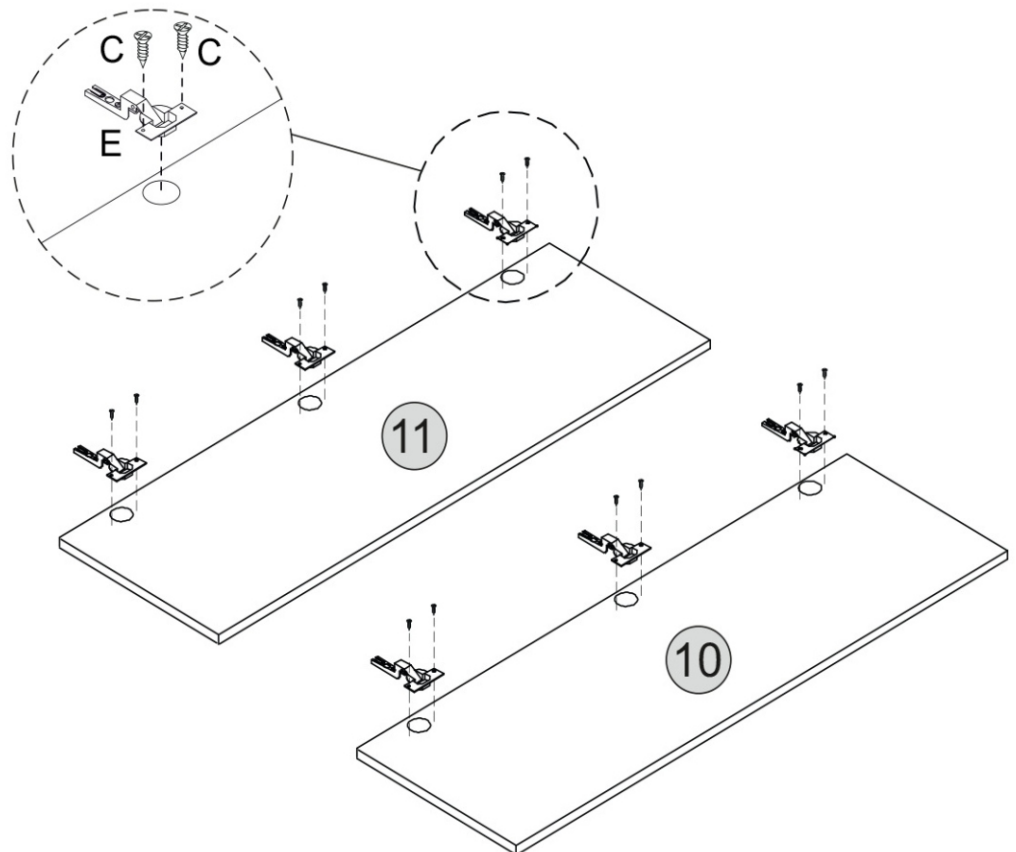
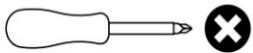

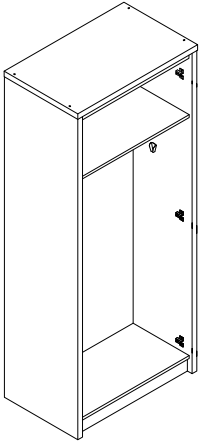

# STEP 9

**PARTS REQUIRED**



**HARDWARE REQUIRED**

C		12
---	---	----

E		06
---	---	----

**TOOLS REQUIRED**

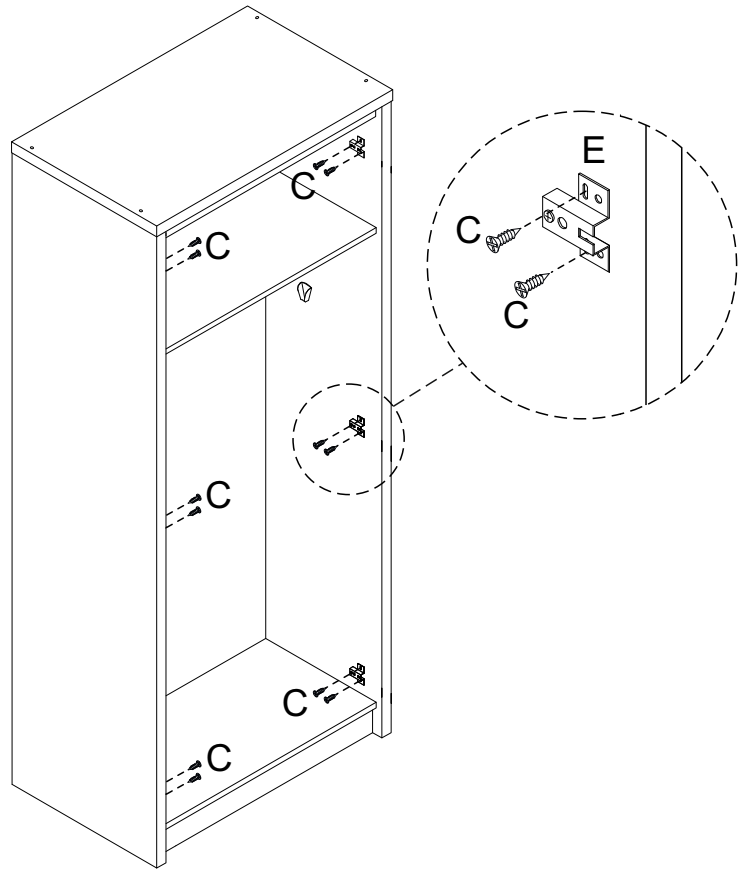
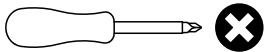

# STEP 10

**PARTS REQUIRED**

10 - RIGHT DOOR	x1
-----------------	----

11 - LEFT DOOR	x1
----------------	----

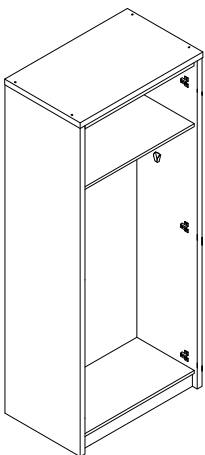

**HARDWARE REQUIRED**

**TOOLS REQUIRED**

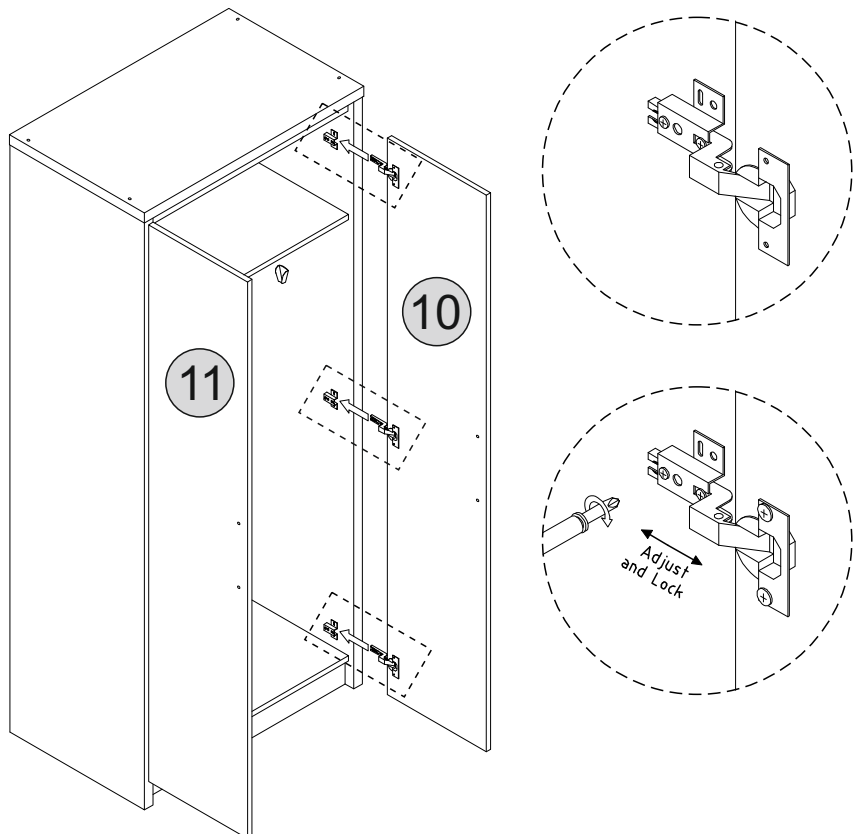
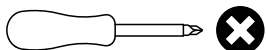



# STEP 11

PARTS REQUIRED

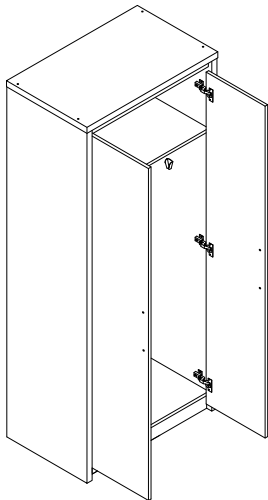

HARDWARE REQUIRED

D		01
G		02
H		04

TOOLS REQUIRED

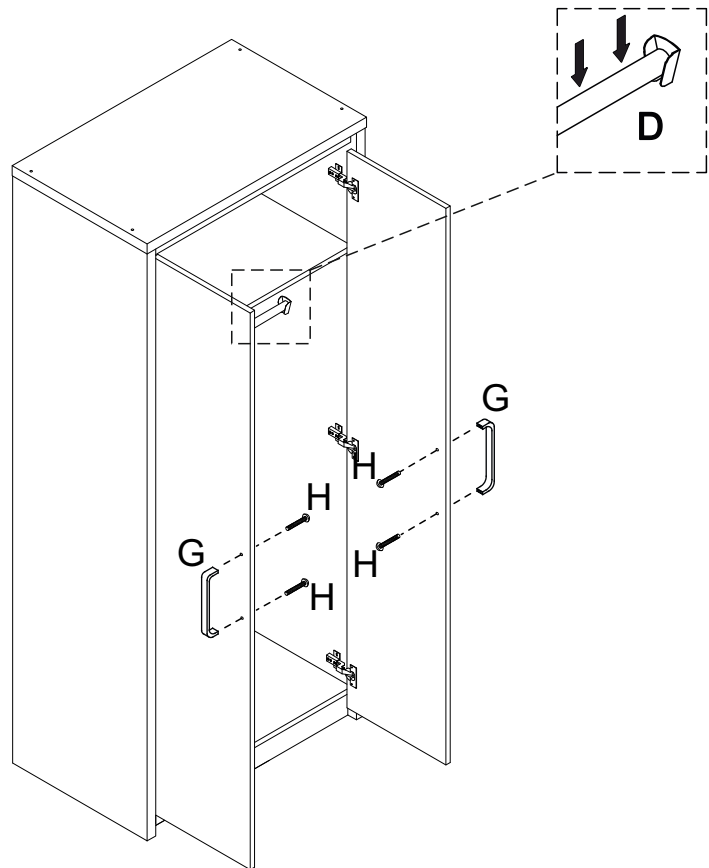
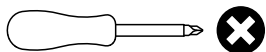

# STEP 12

PARTS REQUIRED

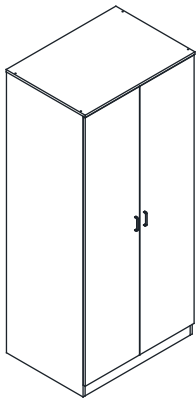

HARDWARE REQUIRED

M		01
---	--	----

TOOLS REQUIRED

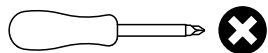

## WARNING

**Serious or fatal injuries can occur from furniture tipping over. To prevent the furniture from tipping over we recommend that it is permanently fixed to the wall.**

Wall fixings are not supplied with this product as different wall materials require different types of fixing devices. Please make sure you use fixings suitable for the walls in your home.

