

NEVADA 3+2 DRAWER CHEST ASSEMBLY INSTRUCTIONS

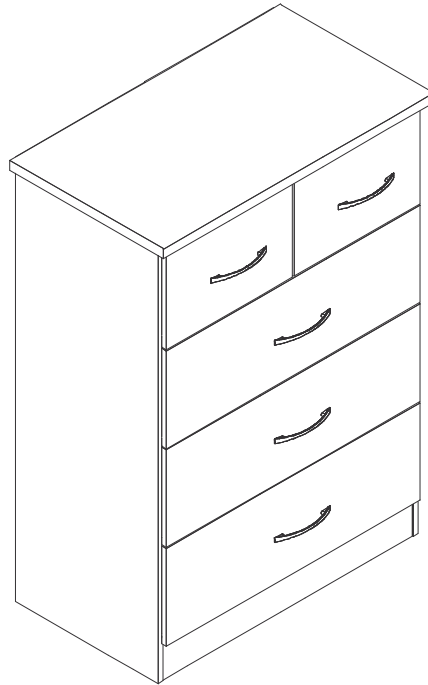

IMPORTANT **FOR DOMESTIC USE ONLY** **PLEASE READ BEFORE YOU CONTINUE FURTHER** **CARE AND MAINTENANCE**

After unpacking this product please keep the original packaging in case it needs to be returned for any reason.

- Please ensure all fittings and parts are present before commencing with assembly.
- Never drag or push products as this could cause damage to the joints making it inferior.
- We strongly recommend that you keep children away from your work area.
- We recommend that you lay a blanket or sheet on the floor to avoid damage to both your floor and the product.
- Assemble this product as close to its final position as possible.
- Do not place this product next to a radiator or in direct sunlight.
- Do not drag or push items across your high gloss furniture as this may cause the surface to scratch
- Wood is a natural product and may expand if subjected to damp and may shrink or crack if subjected to heat. Therefore it is recommended that room temperature is maintained, with no sudden temperature fluctuations.
- Make sure any spillage is wiped off immediately.
- Do not place hot or chilled items directly on to the surface, use a place mat or marking will occur.
- For general cleaning use a soft cotton or micro fibre cloth, and do not use detergents of any kind.
- From time to time it may be necessary to tighten fittings, regular inspections should be carried out.
- Do not place on a wet or damp floor as staining may occur to your floor.

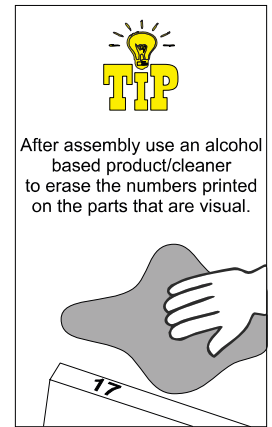
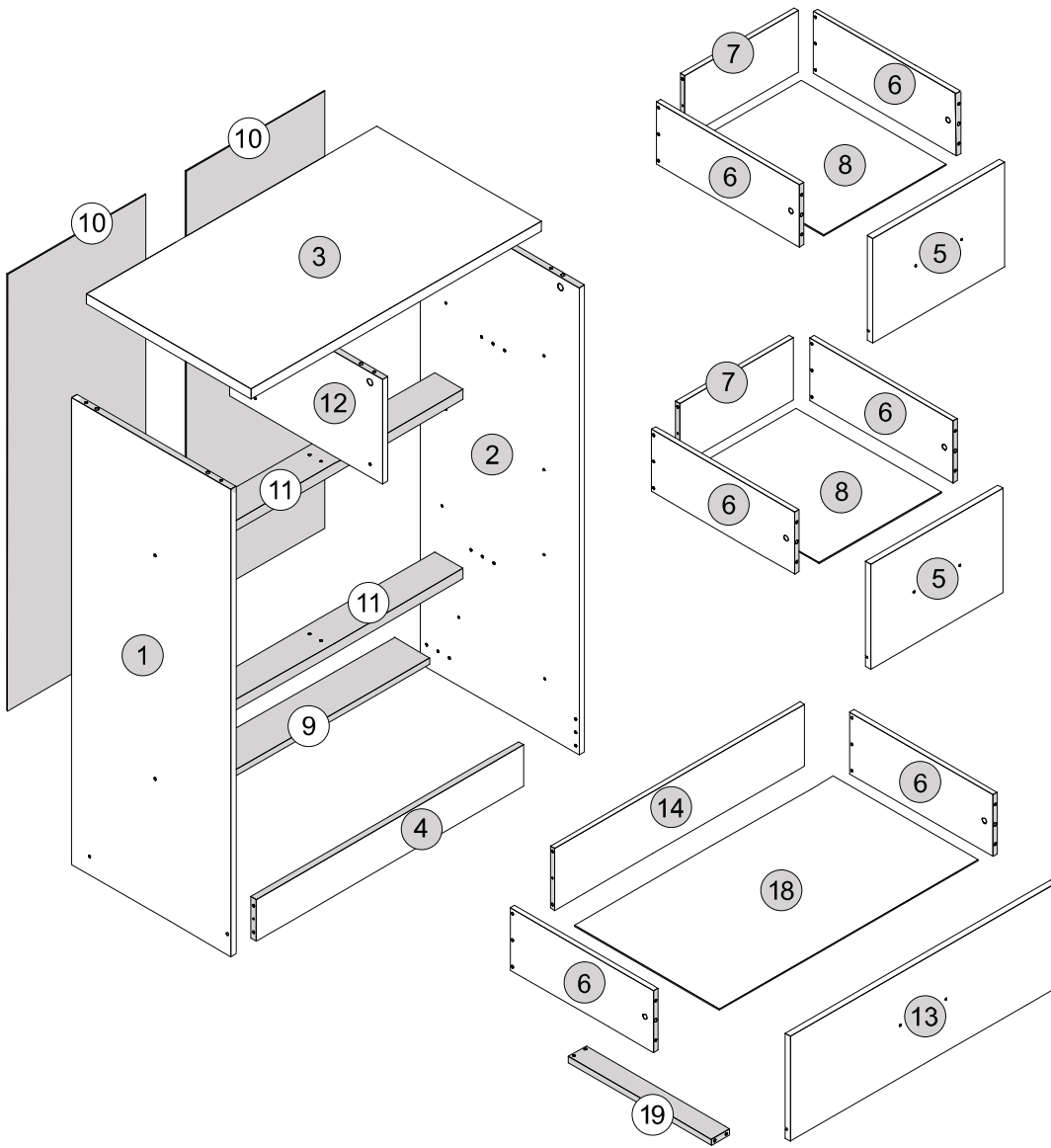

TOOLS REQUIRED

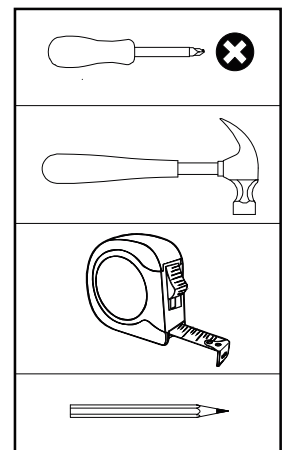









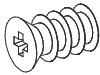
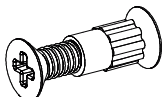
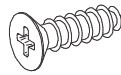
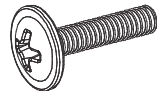
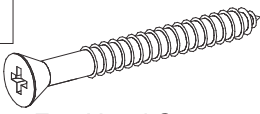
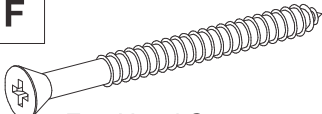
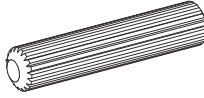

PARTS LIST

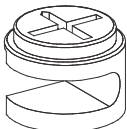
Please Note:

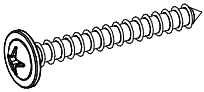
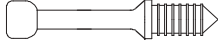
The below parts have all been stamped with the part number to help identify them during assembly.

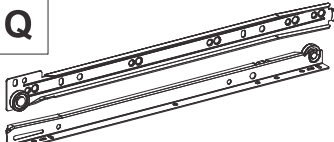
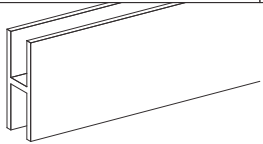
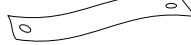
Part Number	Part Description	Quantity	Carton
01	Left Side Panel	1	1/2
02	Right Side Panel	1	1/2
03	Top Panel	1	2/2
04	Front Baseboard	1	1/2
05	Small Drawer Front	2	2/2
06	Drawer Side	10	1/2
07	Small Drawer Back Panel	2	1/2
08	Small Drawer Bottom	2	1/2
09	Back Baseboard	1	1/2
10	Back Panel	2	1/2
11	Crossbar	2	2/2
12	Division Panel	1	1/2
13	Large Drawer Front	3	2/2
14	Large Drawer Back Panel	3	1/2
18	Large Drawer Bottom	3	2/2
19	Drawer Bottom Support Bar	3	1/2

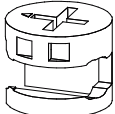
FITTINGS LIST

<p>A</p>  <p>Flat Head Screw 2/+ Ø6,0 x 10mm (16x)</p>	<p>B</p>  <p>Double Flat Head Screw 1/+ Ø4,0 x 18mm (2x)</p>	<p>C</p>  <p>Flat Head Screw 2/+ Ø4,0 x 14mm (30x)</p>	<p>D</p>  <p>Flan Head Screw 2/+ Ø4,0 x 20mm (10x)</p>
<p>E</p>  <p>Flat Head Screw 1/+ Ø3,5 x 40mm (6x)</p>	<p>F</p>  <p>Flat Head Screw 2/+ Ø4,0 x 50mm (19x)</p>	<p>G</p>  <p>2/+ Dowel Ø6,0 x 30mm (69x)</p>	<p>H</p>  <p>2/+ Nail 10x10 Ringed-1,5x23mm (84x)</p>
<p>I</p>  <p>1/+ Back Panel Bracket 14x14mm (2x)</p>	<p>J</p>  <p>2/+ Cam Nut Ø12x8,8MM (10x)</p>	<p>K</p>  <p>1/+ Washer Ø16x7 (4x)</p>	<p>L</p>  <p>1/+ Plastic Foot L 19x17x8mm Ø2 (6x)</p>
<p>M</p>  <p>Flan Head Screw 1/+ Ø3,5 x 30mm (2x)</p>	<p>N</p>  <p>2/+ Cam Bolt (16x)</p>	<p>O</p>  <p>2/+ Hole Plugs 19MM (9x)</p>	<p>P</p>  <p>Glue 10Gr (3x)</p>
<p>Q</p>  <p>Drawer Runners 400MM (5x)</p>	<p>R</p>  <p>Back Panel Strip H 799x19x3,8mm (1x)</p>	<p>S</p>  <p>Strap 200x20x1MM (2x)</p>	<p>T</p>  <p>Handle (5x)</p>
<p>U</p>  <p>1/+ Cam Nut Ø14,9x11MM (6x)</p>	<p>V</p>  <p>+2 Hole Plugs Líneo 19mm (9x)</p>		

TIPS FOR FITTINGS CAM-LOCKS

WHEN FITTING CAM NUT, ENSURE STARTING POSITION IS CORRECT BEFORE YOU INSERT CONNECTING CAM BOLT TURN CLOCKWISE UNTIL SECURE



↑
CORRECT



WRONG

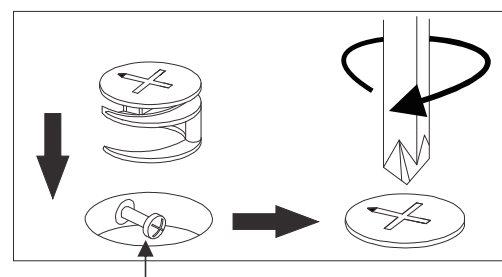

Cam bolt head needs to be in centre

CAMBOLT

Tighten until shoulder is flush with panel. Do not overtighten or undertighten (see example below)

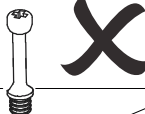

Panel

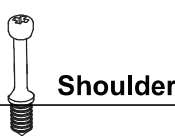

Shoulder



Panel

STEP 1

PARTS REQUIRED

1 - LEFT SIDE PANEL x1

HARDWARE REQUIRED

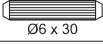
G  02
Ø6 x 30

H  02
10 x 10

L  02

P  01
GLUE

TOOLS REQUIRED

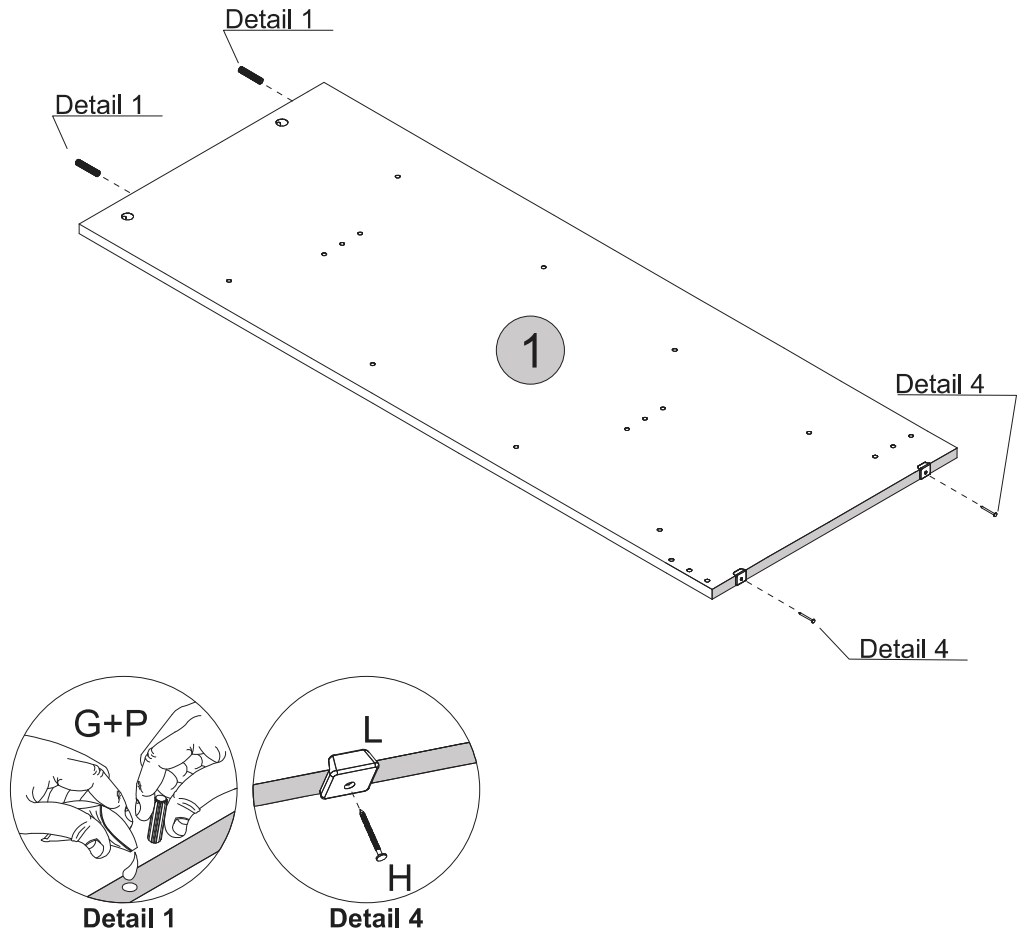
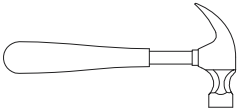



STEP 2

PARTS REQUIRED

2 - RIGHT SIDE PANEL x1

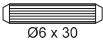
HARDWARE REQUIRED

G  02
Ø6 x 30

H  02
10 x 10

L  02

P  01
GLUE

TOOLS REQUIRED

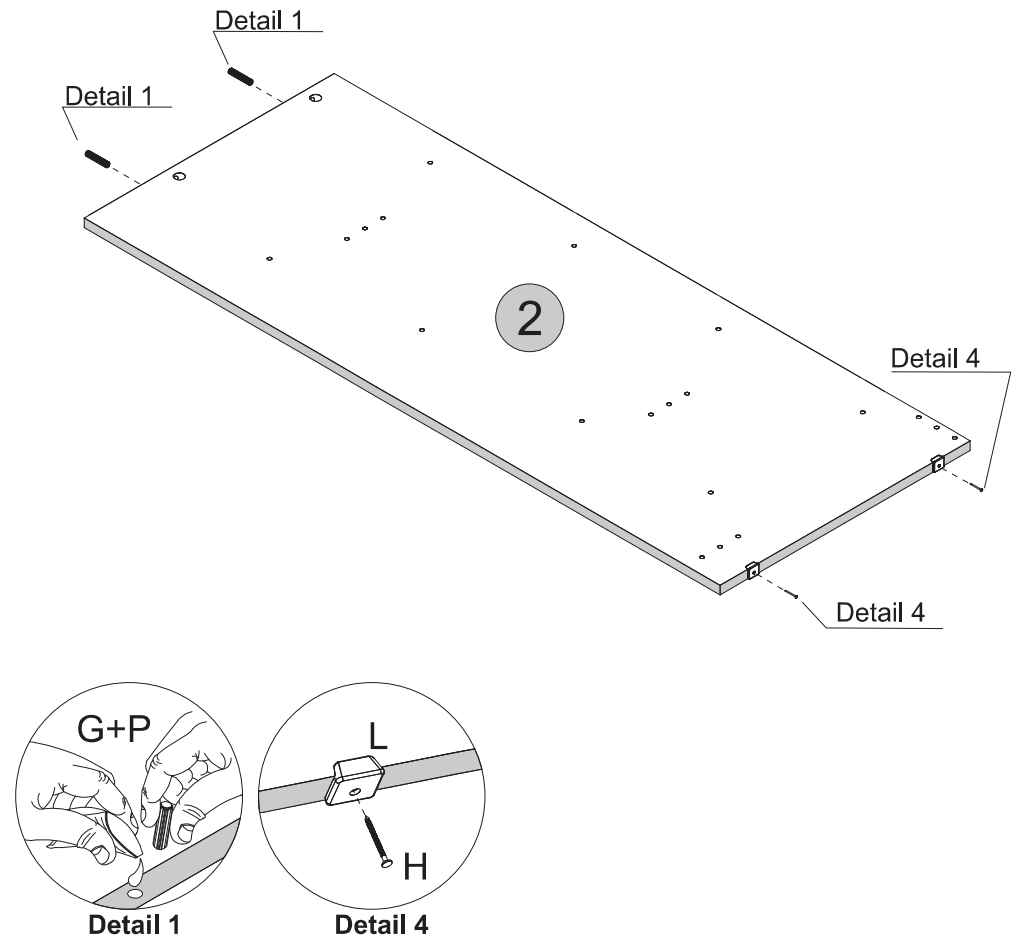
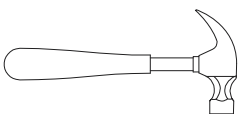

STEP 3

PARTS REQUIRED

1 - LEFT SIDE PANEL x1

HARDWARE REQUIRED

A  08
Ø6 x 10

Q  04
LEFT

TOOLS REQUIRED

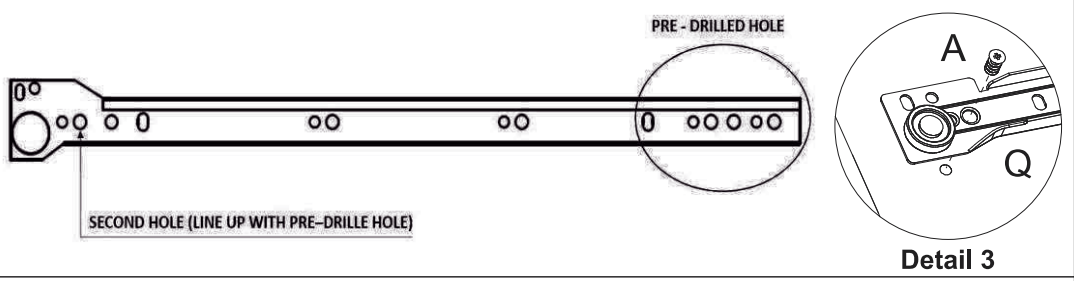
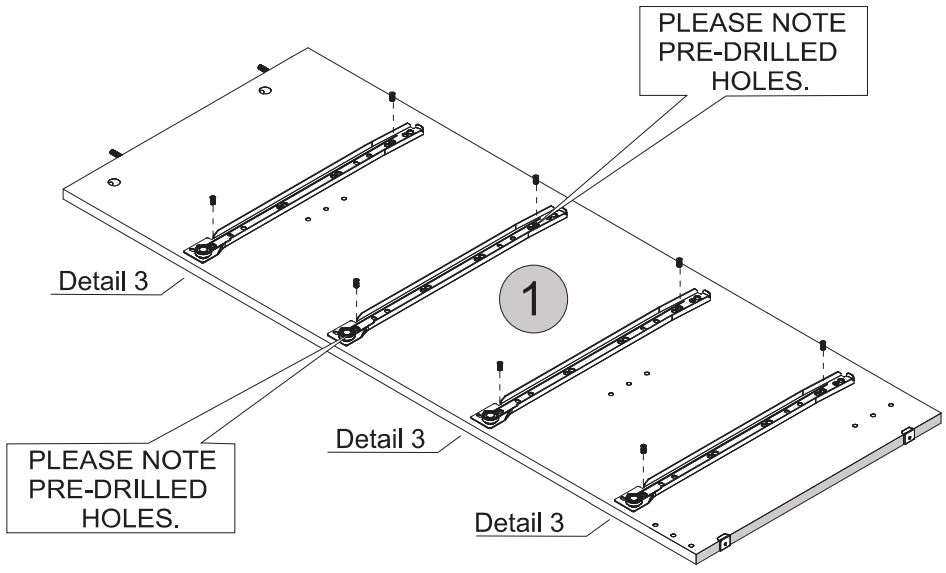
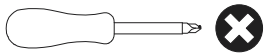

STEP 4

PARTS REQUIRED

2 - RIGHT SIDE PANEL x1

HARDWARE REQUIRED

A  08
Ø6 x 10

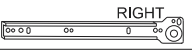
Q  04
RIGHT

TOOLS REQUIRED

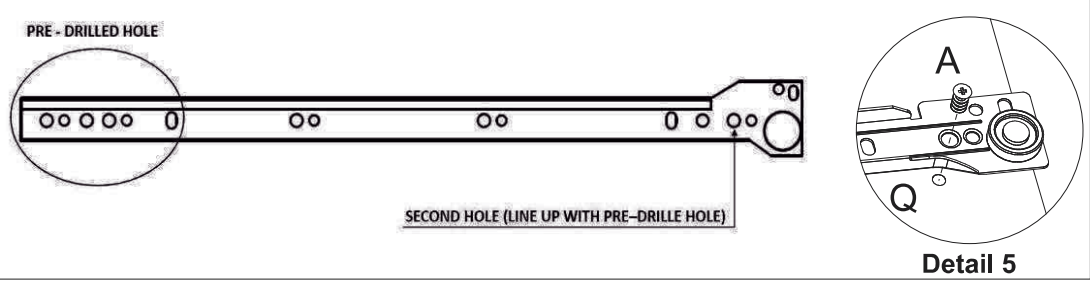
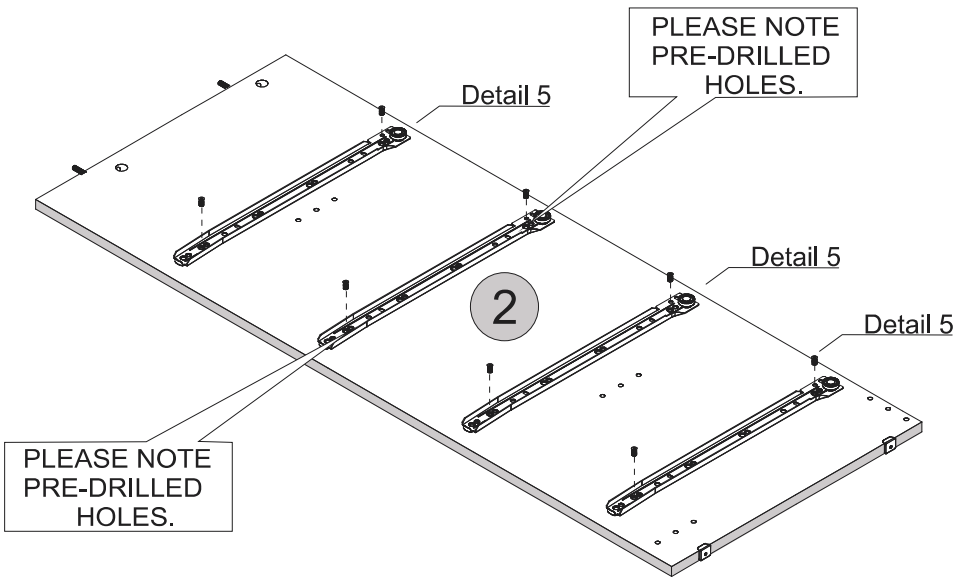
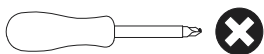

STEP 5

PARTS REQUIRED

4 - FRONT BASEBOARD x1

9 - BACK BASEBOARD x1

11 - CROSSBAR x2

HARDWARE REQUIRED

G  16
Ø6 x 30

H  02
10 x 10

L  02

P  01
GLUE

TOOLS REQUIRED

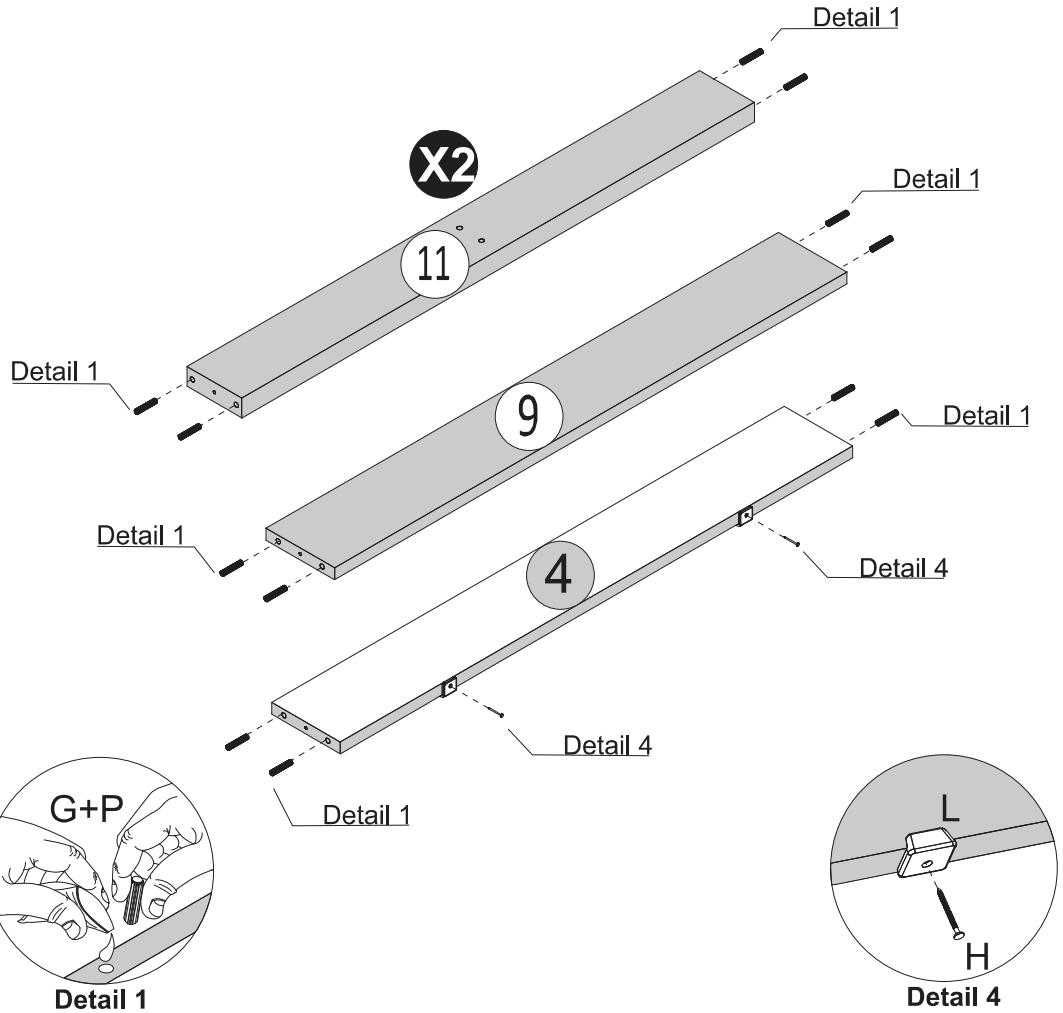
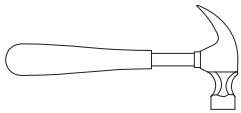

STEP 6

PARTS REQUIRED

12 - DIVISION PANEL x1

HARDWARE REQUIRED

B  02
Ø4.0 x 18mm

G  03
Ø6 x 30

P  01
GLUE

Q  01
LEFT

Q  01
RIGHT

TOOLS REQUIRED

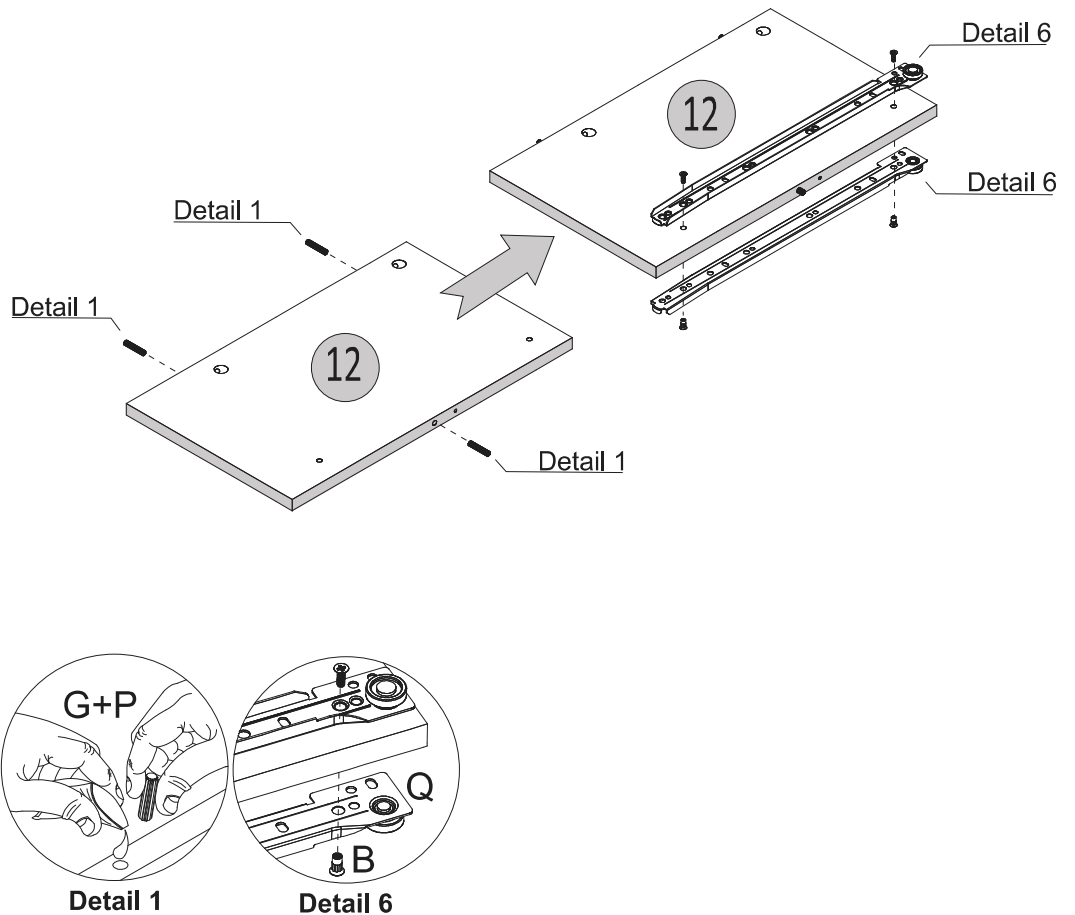
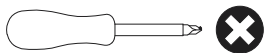



STEP 7

PARTS REQUIRED

- 2 - RIGHT SIDE PANEL x1
- 4 - FRONT BASEBOARD x1
- 9 - BACK BASEBOARD x1
- 11 - CROSSBAR x2

HARDWARE REQUIRED

- F  04
Ø4 x 50
- P  01

TOOLS REQUIRED

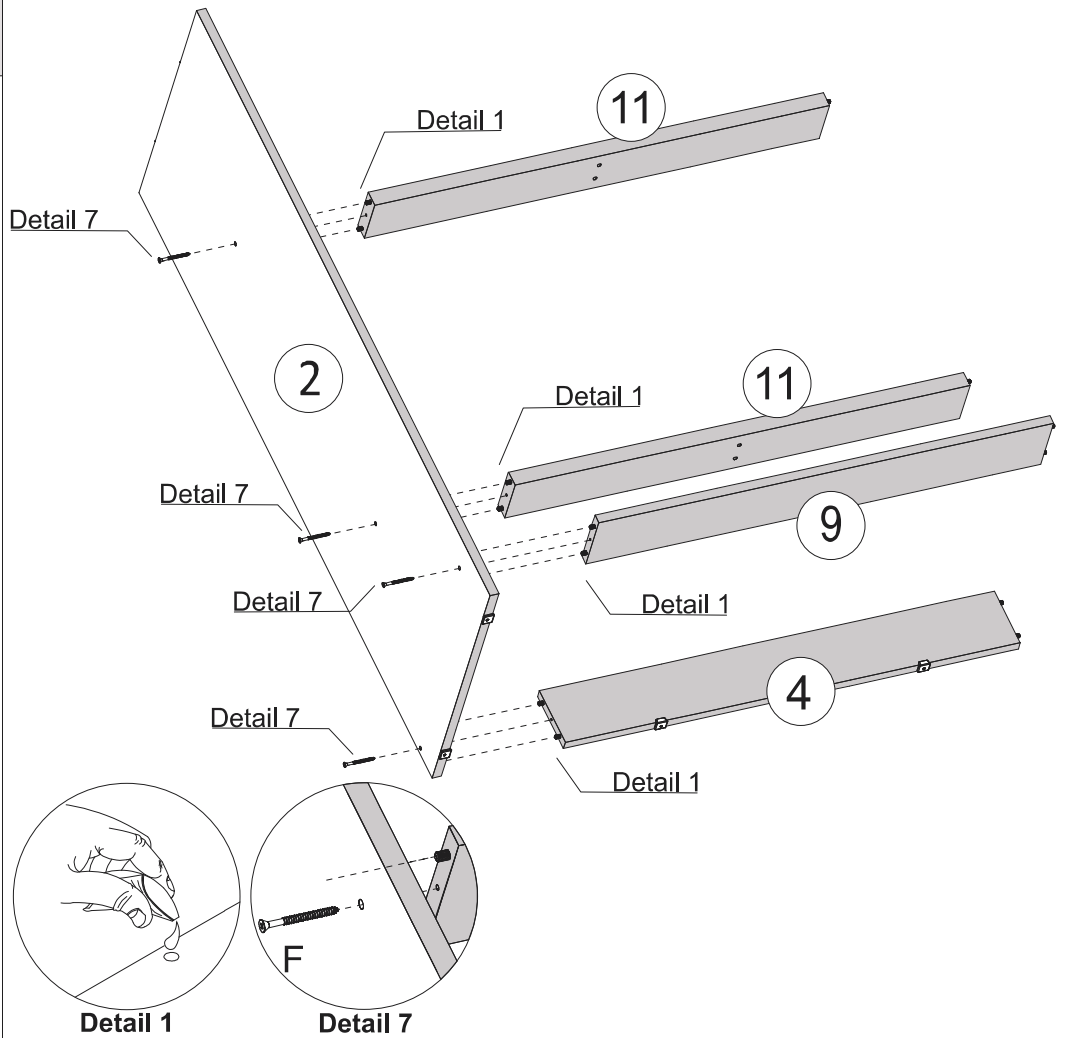
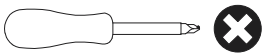



STEP 8

PARTS REQUIRED

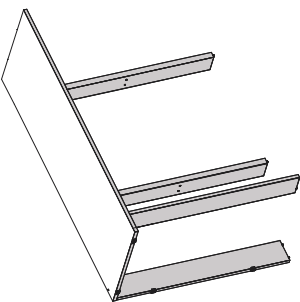
- 1 - LEFT SIDE PANEL x1



HARDWARE REQUIRED

- F  04
Ø4 x 50
- P  01

TOOLS REQUIRED

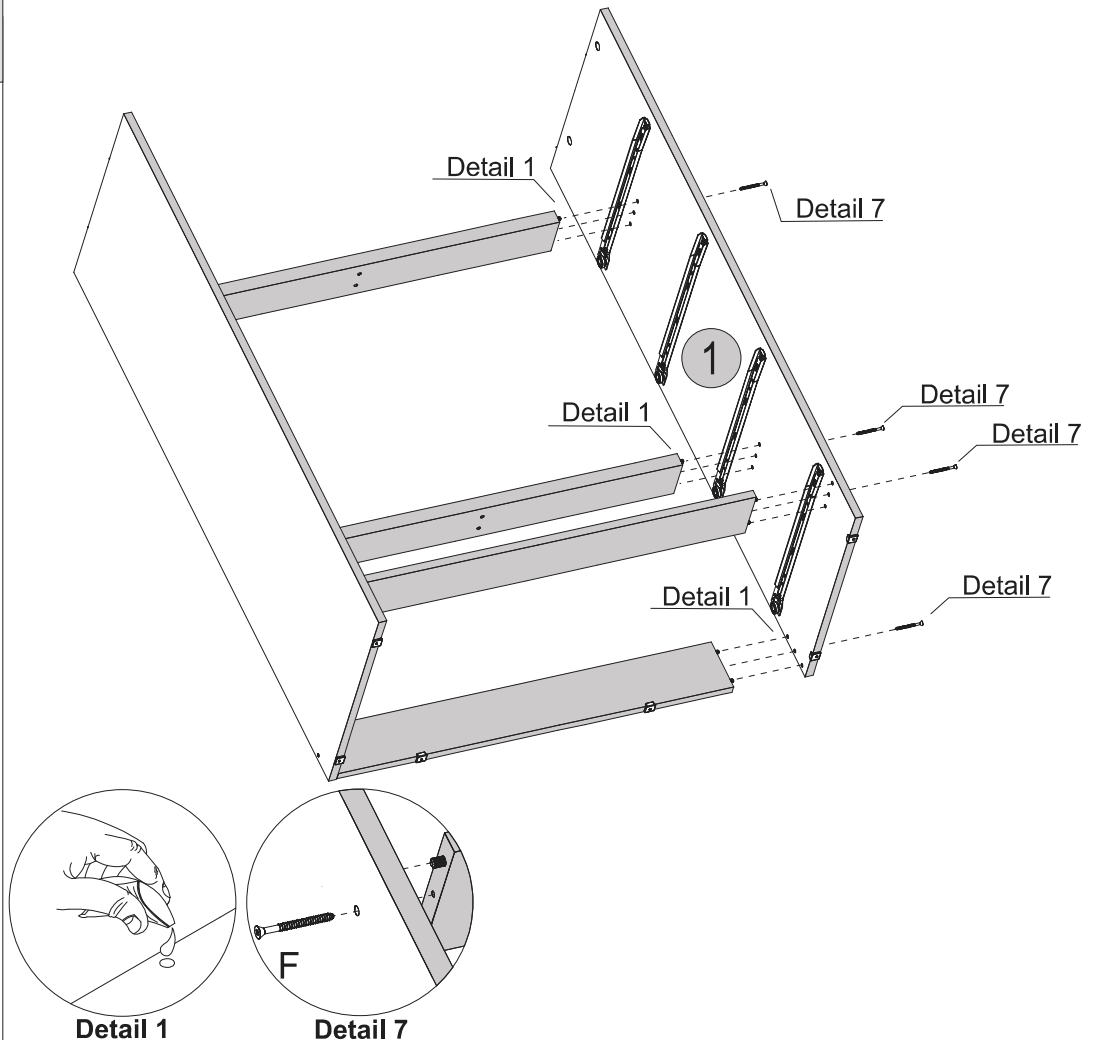
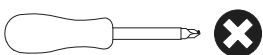

STEP 9

PARTS REQUIRED

3 - TOP PANEL x1

HARDWARE REQUIRED

N  06

TOOLS REQUIRED

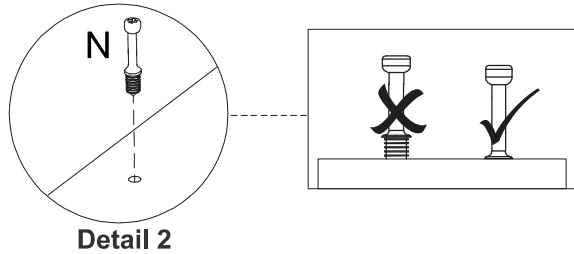
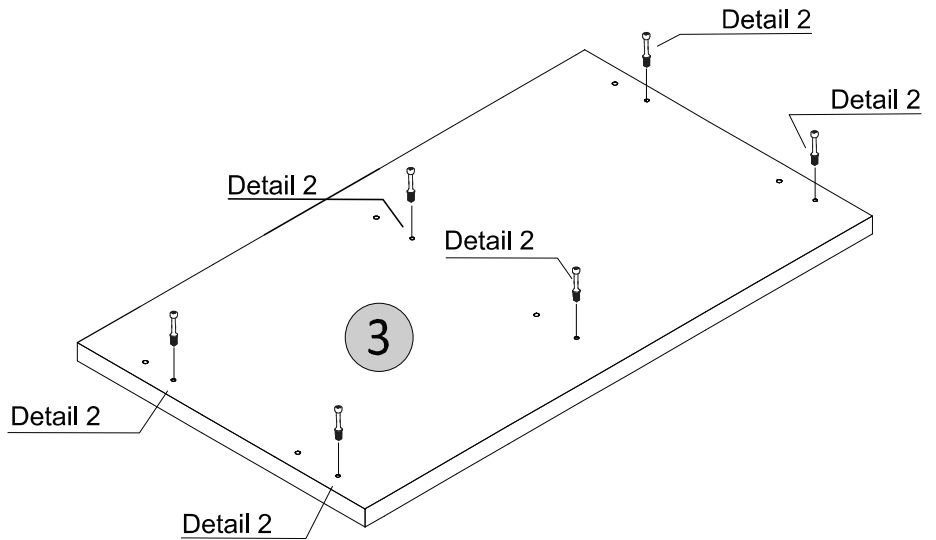
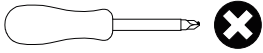

STEP 10

PARTS REQUIRED

3 - TOP PANEL x1

12 - DIVISION PANEL x1

HARDWARE REQUIRED

U  02

TOOLS REQUIRED

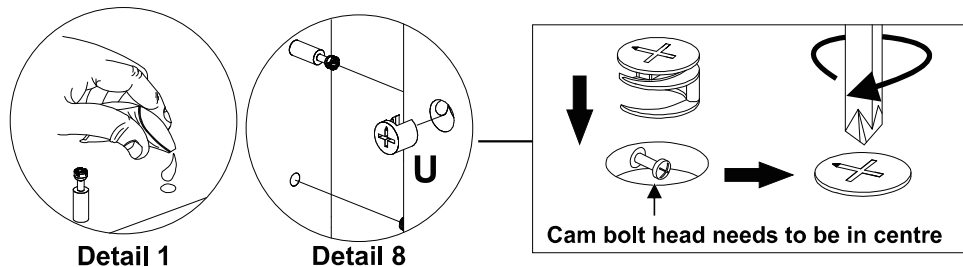
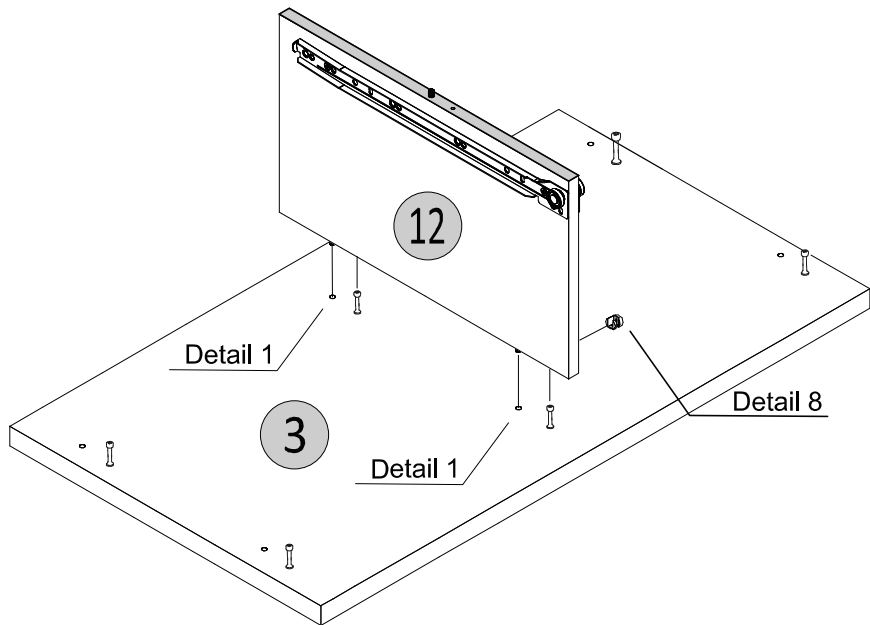
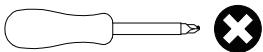

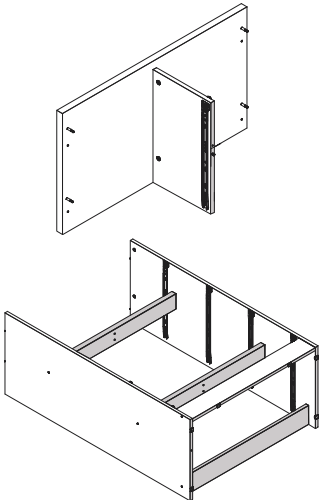

STEP 11

PARTS REQUIRED



HARDWARE REQUIRED

F	 Ø4 x 50	01
P		01
U		04

TOOLS REQUIRED

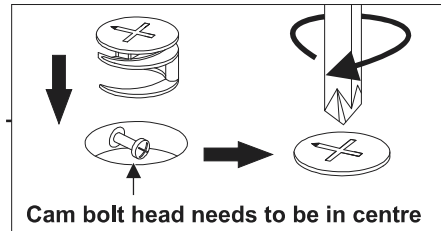
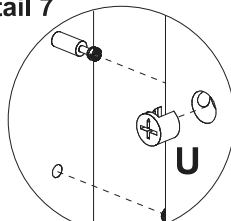
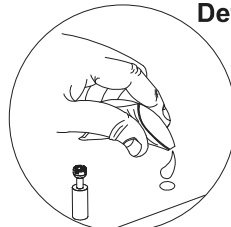
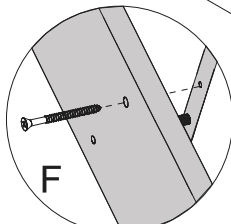
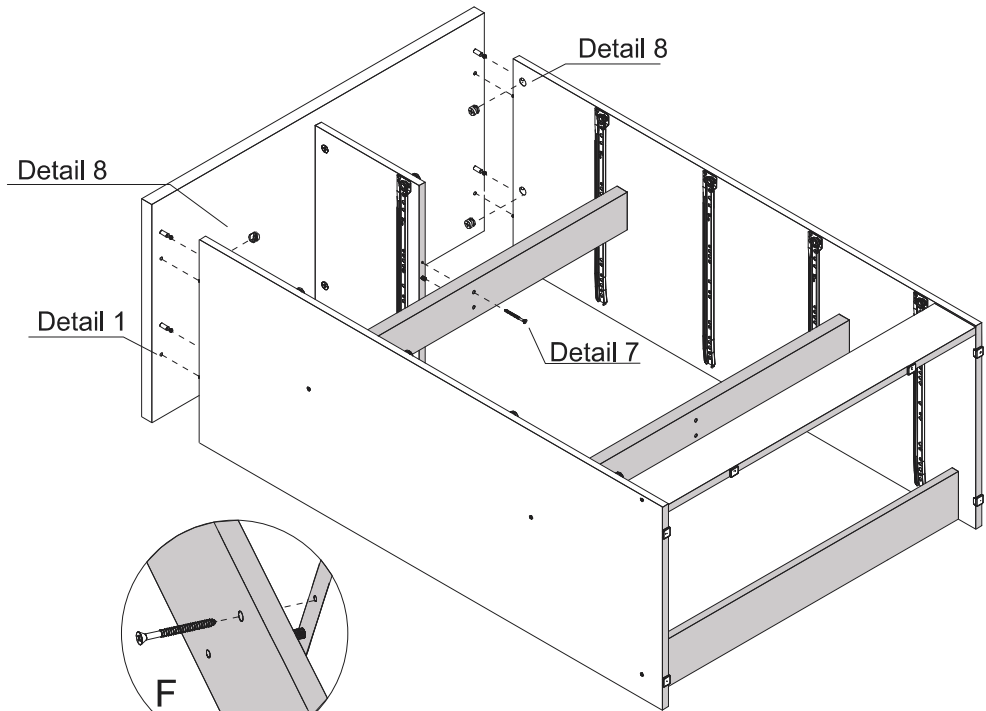
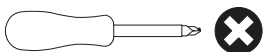



STEP 12

PARTS REQUIRED

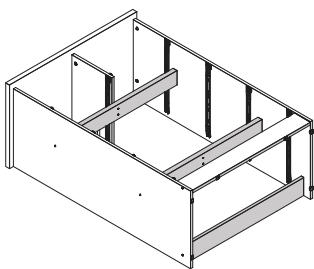
10 - BACK PANEL	x2
-----------------	----



HARDWARE REQUIRED

H		32
I		02
R		01

TOOLS REQUIRED

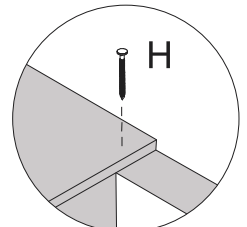
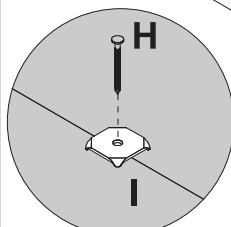
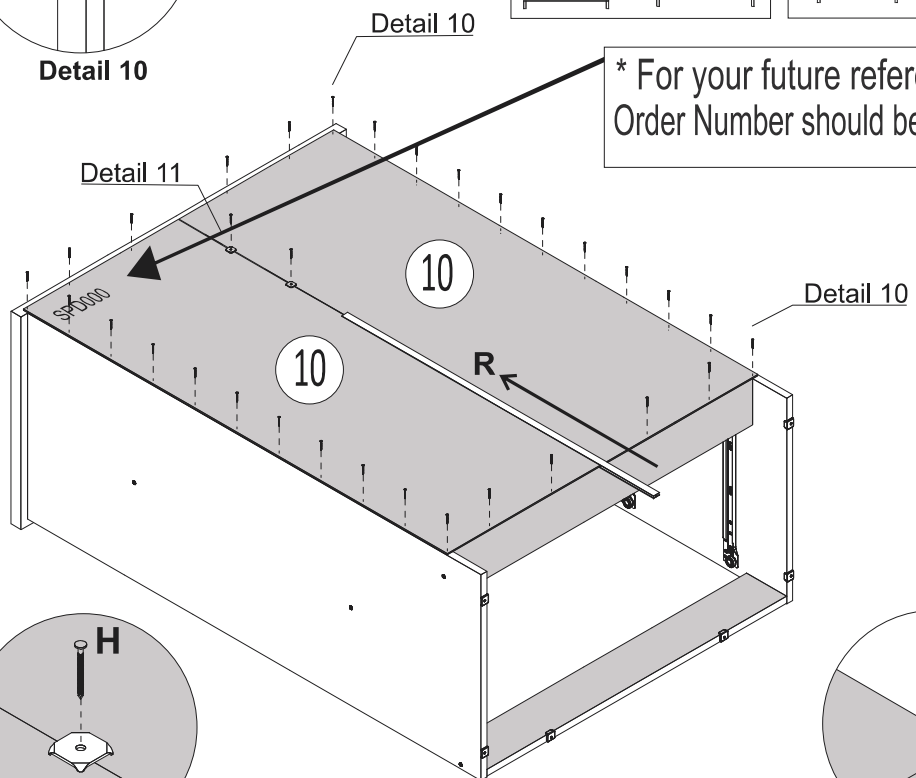
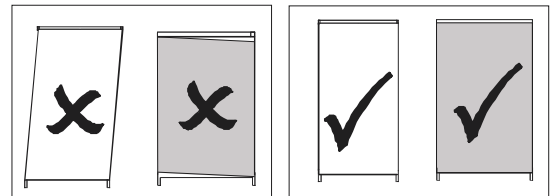
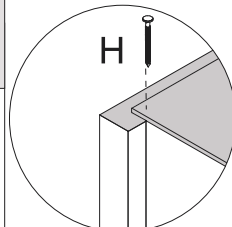
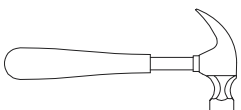



STEP 13

PARTS REQUIRED

- 6 - DRAWER SIDE x10
- 7 - SMALL DRAWER BACK PANEL x2
- 14 -LARGE DRAWER BACK PANEL x3
- 19 -DRAWER BOTTOM SUPPORT BAR x3

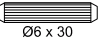
HARDWARE REQUIRED

- G  46
- P  01

TOOLS REQUIRED



Detail 1

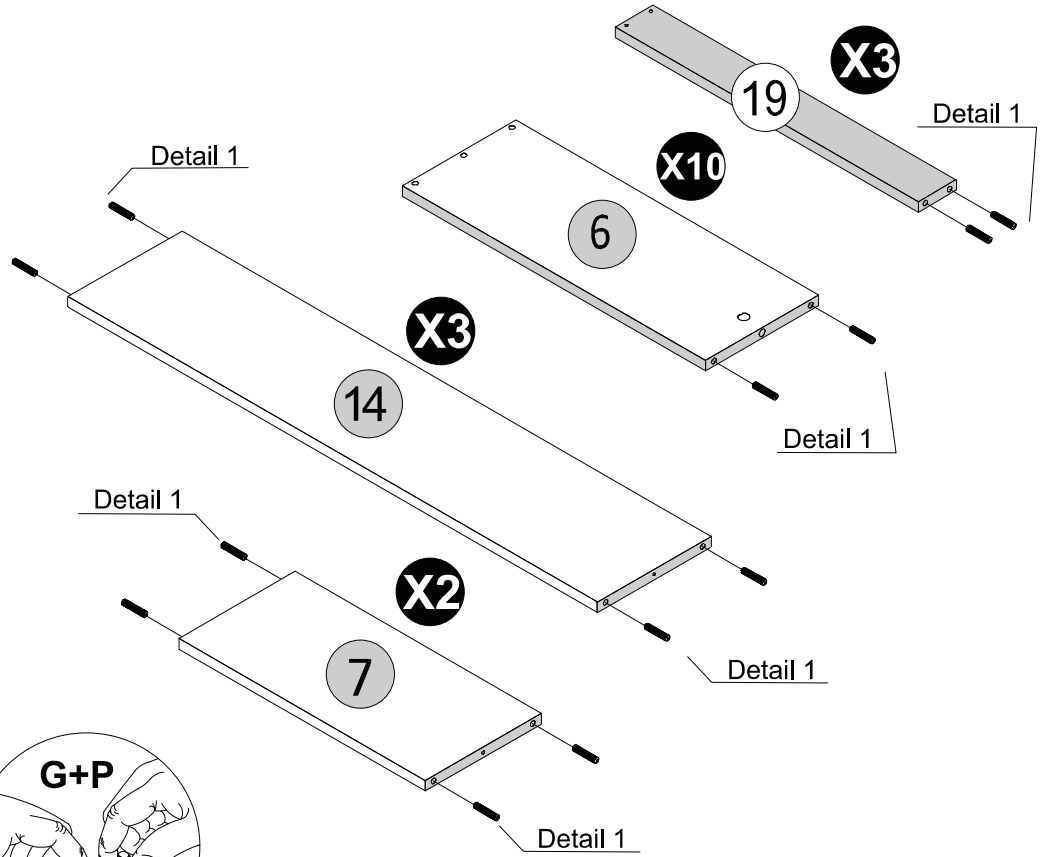

STEP 14

PARTS REQUIRED

- 13 -LARGE DRAWER FRONT x3
- 5 - SMALL DRAWER FRONT x2

HARDWARE REQUIRED

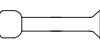
- N  10

TOOLS REQUIRED

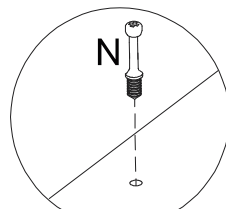
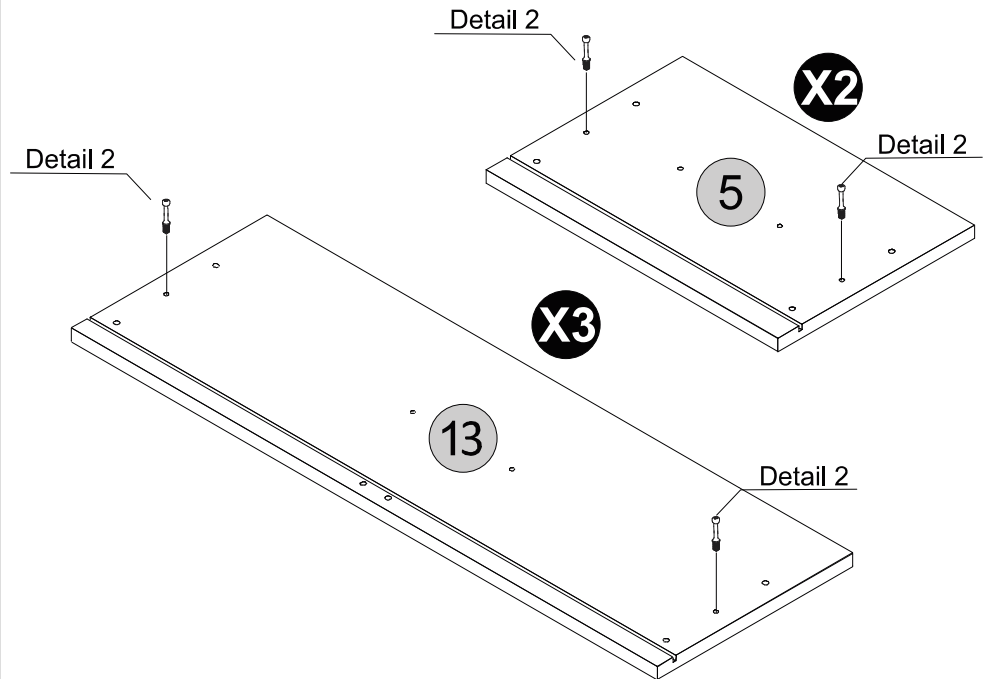
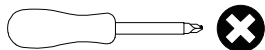

Detail 2

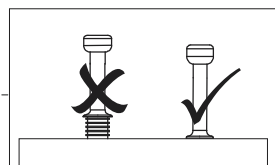

STEP 15

PARTS REQUIRED

6 - DRAWER SIDE x6

14 - LARGE DRAWER BACK PANEL x3

HARDWARE REQUIRED

F  06
Ø4 x 50

TOOLS REQUIRED

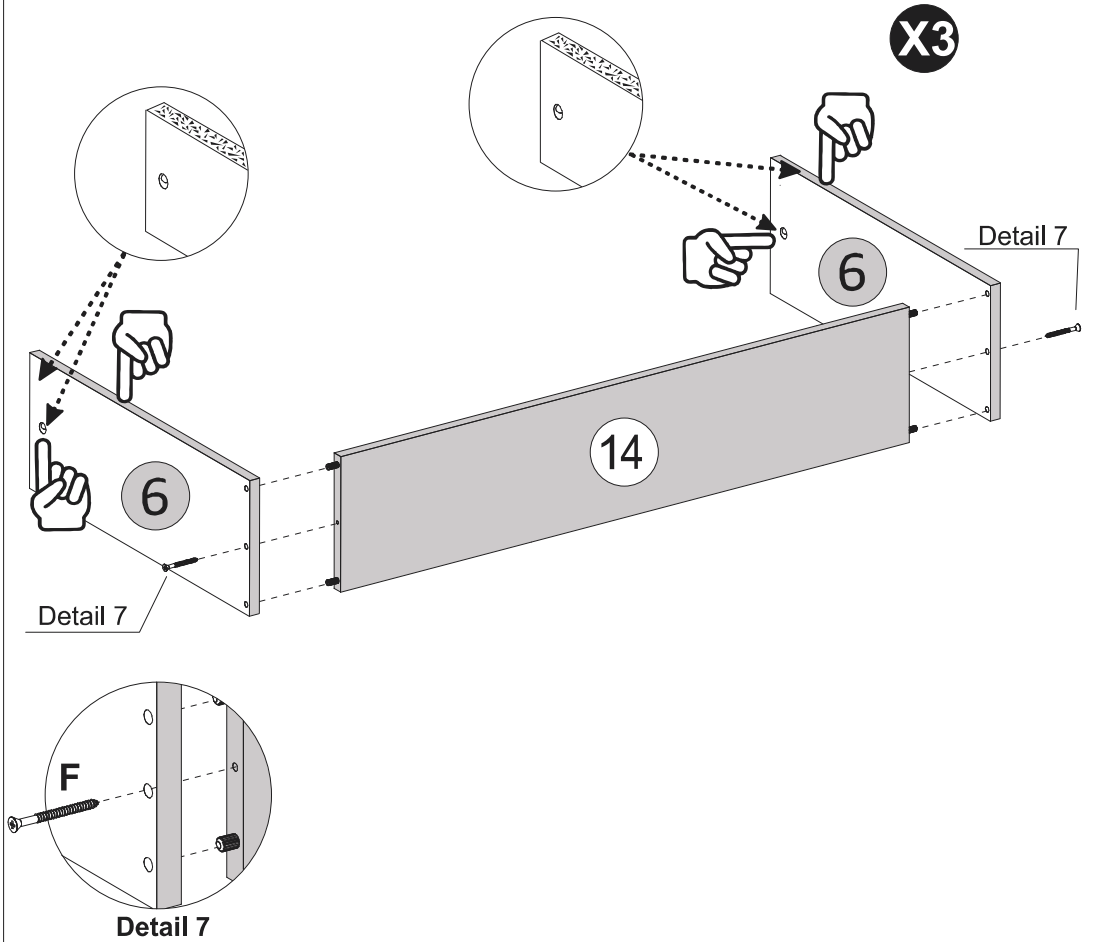
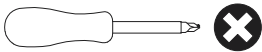

STEP 16

PARTS REQUIRED

13 - LARGE DRAWER FRONT x3

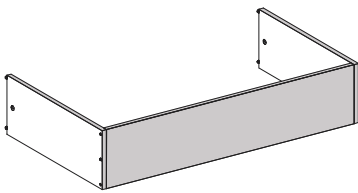

HARDWARE REQUIRED

J  06

P  01
GLUE

TOOLS REQUIRED

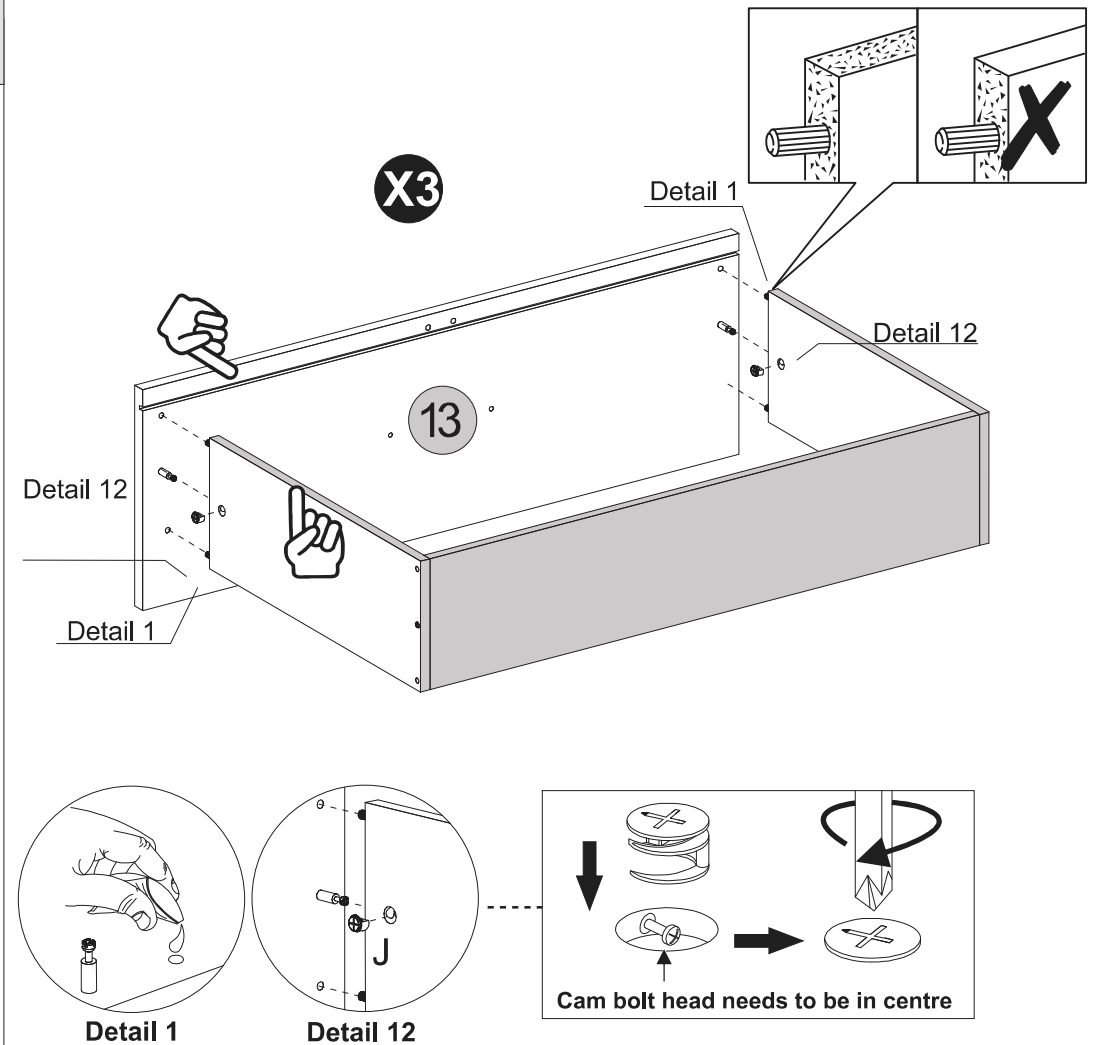
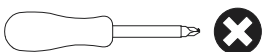

STEP 17

PARTS REQUIRED

18 - LARGE DRAWER BOTTOM x3

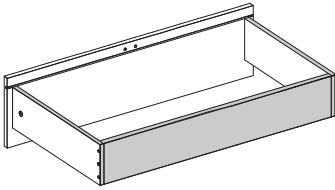

HARDWARE REQUIRED

H  12
10 x 10

TOOLS REQUIRED

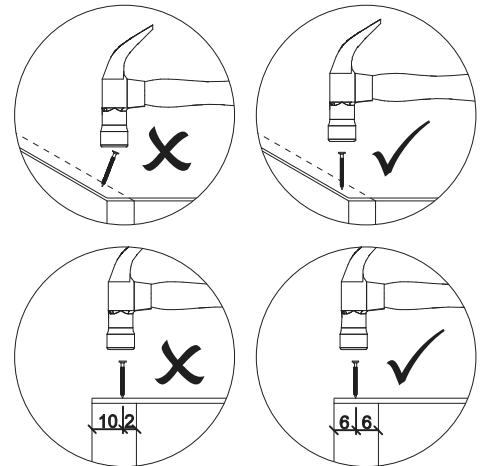
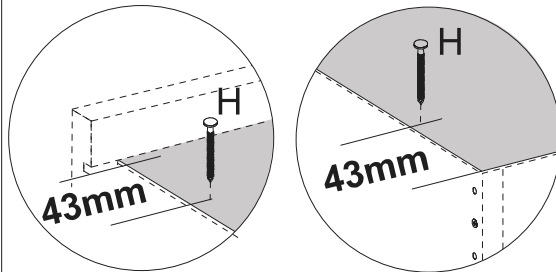
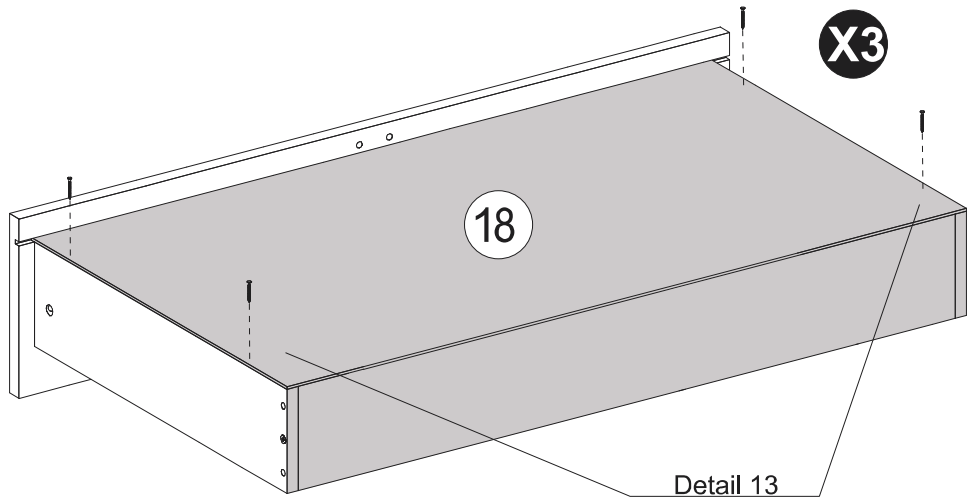
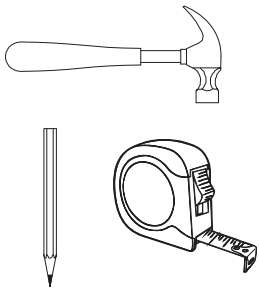

Detail 13

STEP 18

PARTS REQUIRED

19 - DRAWER BOTTOM SUPPORT BAR x3

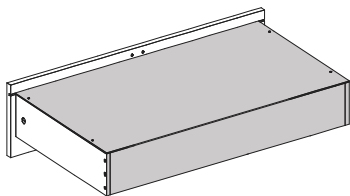

HARDWARE REQUIRED

H  18
10 x 10

P  01
GLUE

TOOLS REQUIRED

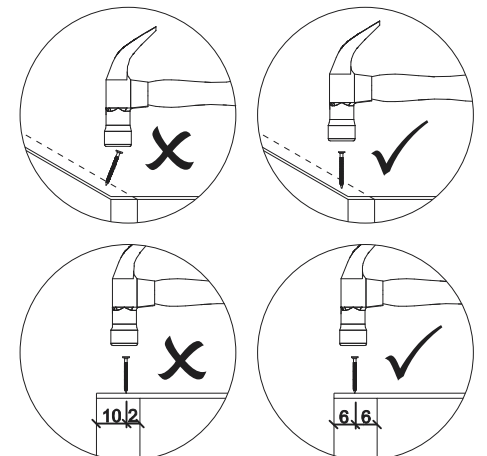
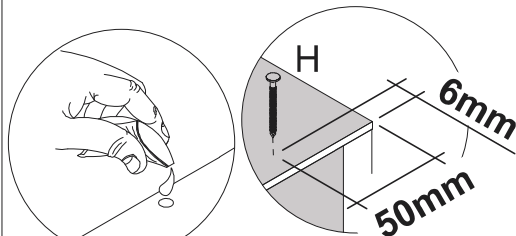
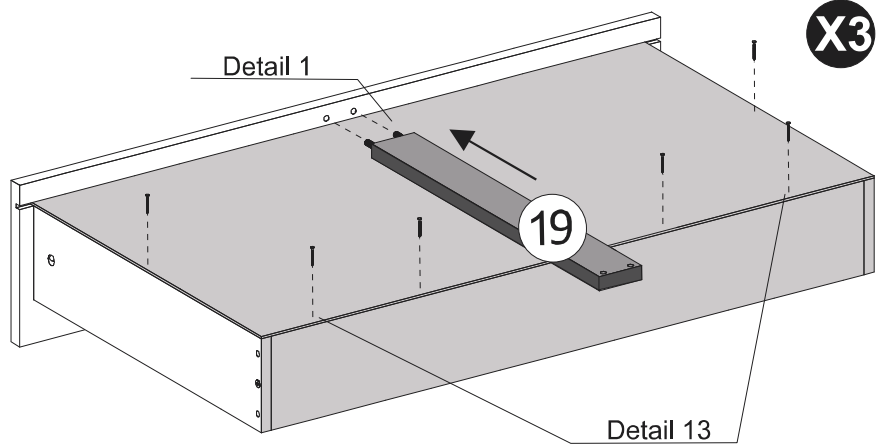
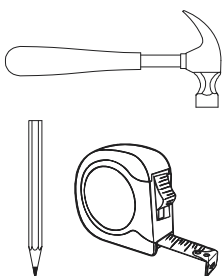

Detail 1



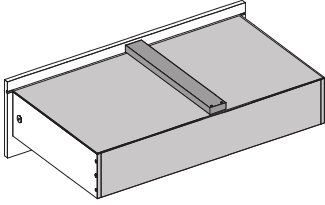

Detail 13

STEP 19

PARTS REQUIRED



HARDWARE REQUIRED

C		12
	Ø4,0 x 14mm	
E		06
	Ø3,5 x 40mm	
Q		03
	LEFT	
Q		03
	RIGHT	

TOOLS REQUIRED

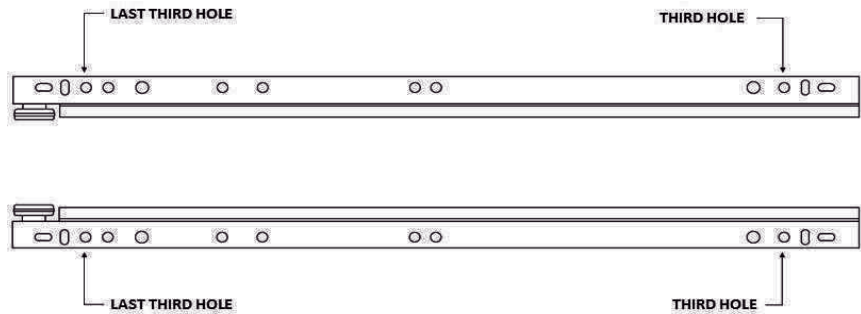
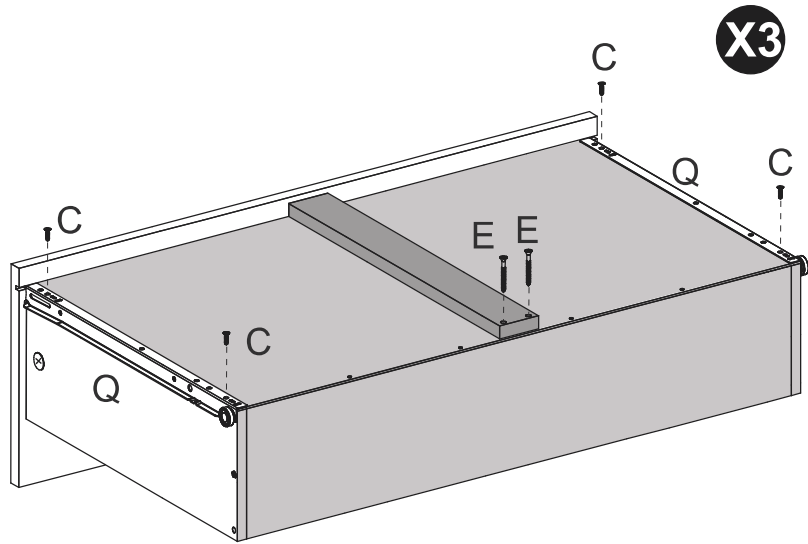
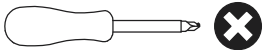

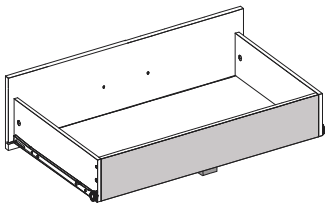

STEP 20

PARTS REQUIRED



HARDWARE REQUIRED

D		06
	4 x 22	
T		03
O		06

TOOLS REQUIRED

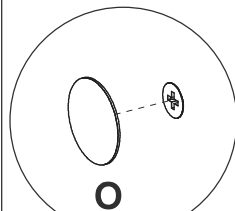
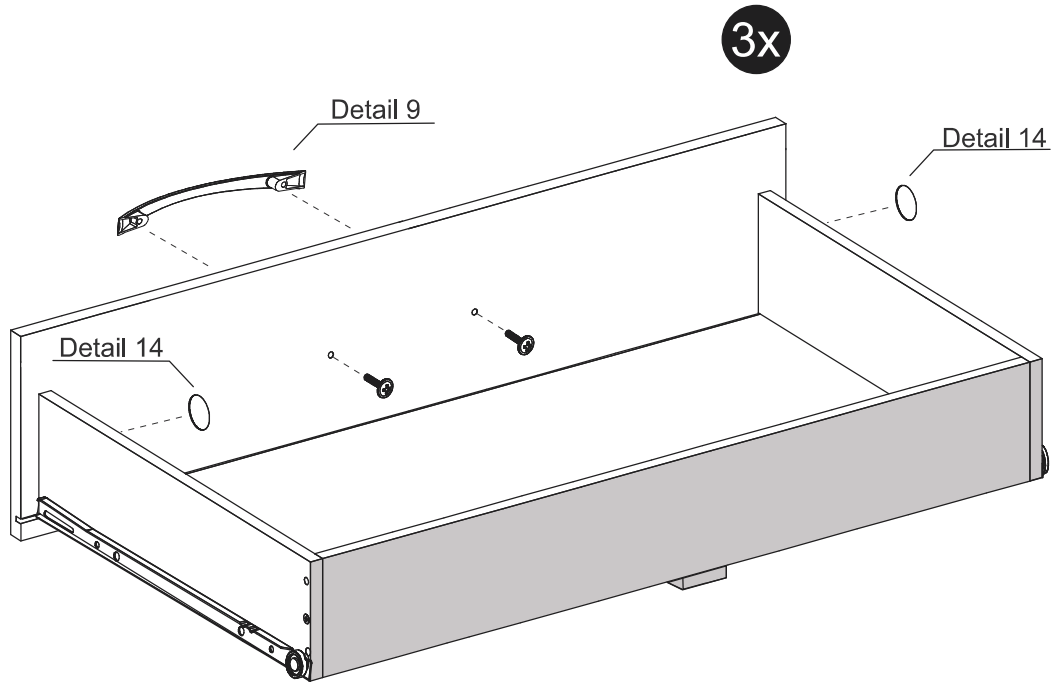
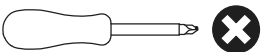

Detail 14

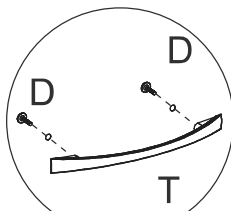

Detail 9

STEP 21

PARTS REQUIRED

6 - DRAWER SIDE x6

7 - DRAWER BACK PANEL x3

HARDWARE REQUIRED

F  04
Ø4 x 50

TOOLS REQUIRED

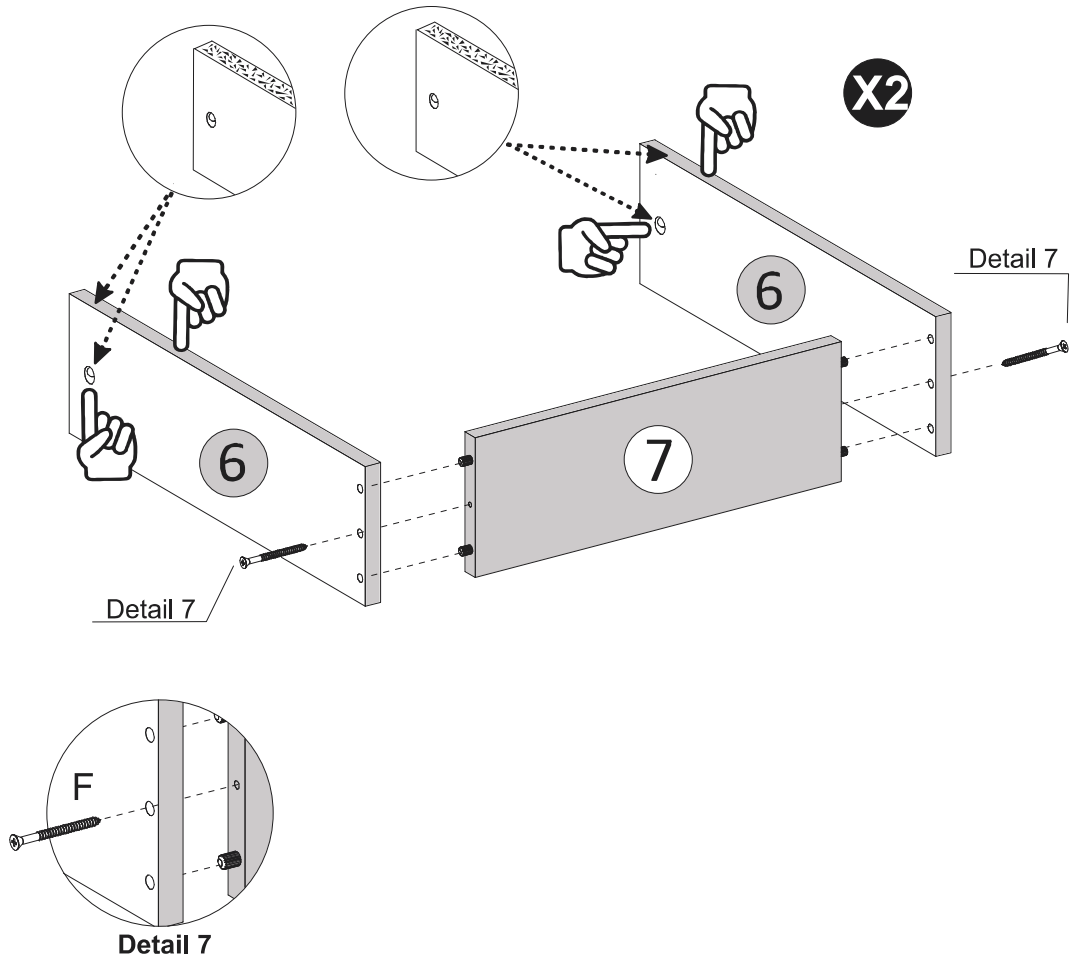
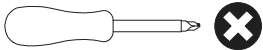

STEP 22

PARTS REQUIRED

5 - SMALL DRAWER FRONT x3

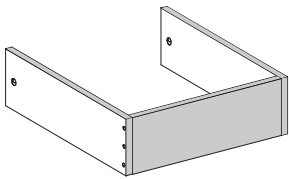

HARDWARE REQUIRED

J  04

P  01
GLUE

TOOLS REQUIRED

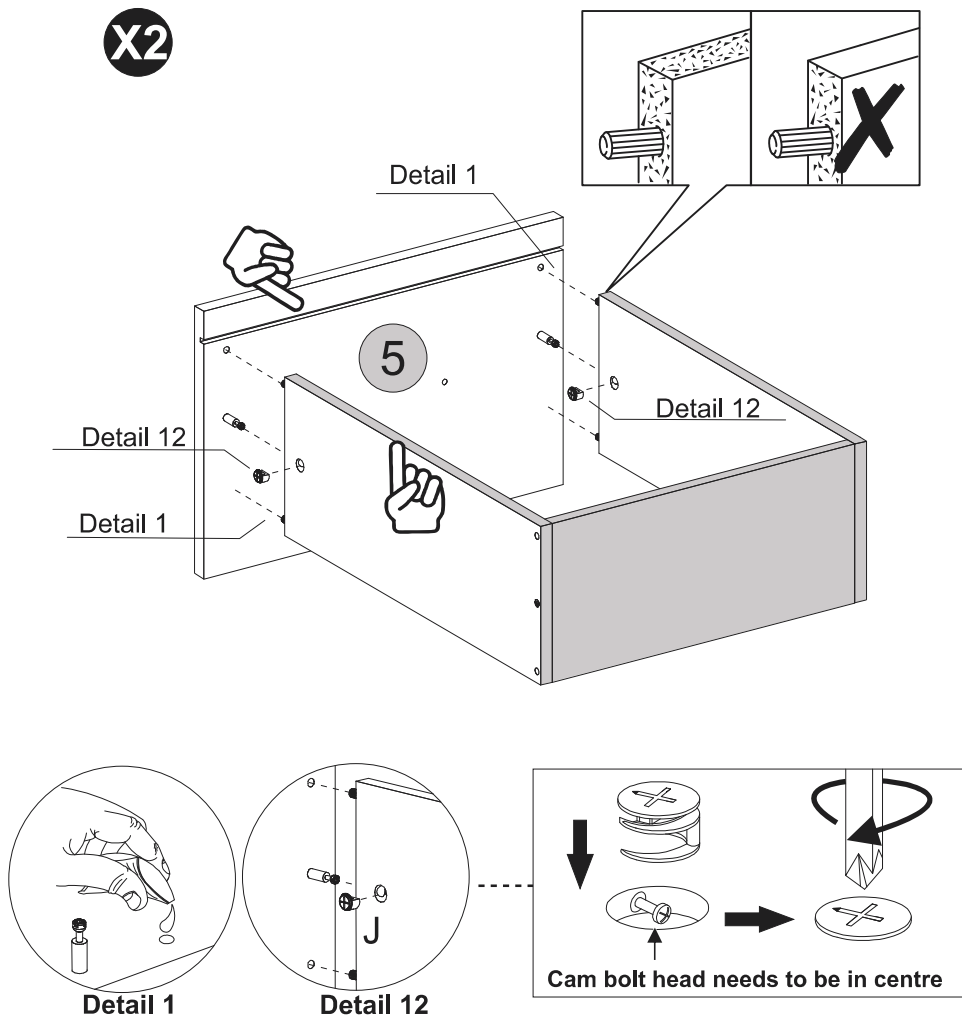
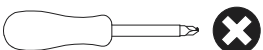

STEP 23

PARTS REQUIRED

8 - DRAWER BOTTOM x2

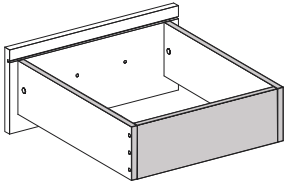

HARDWARE REQUIRED

H  08
10 x 10

TOOLS REQUIRED

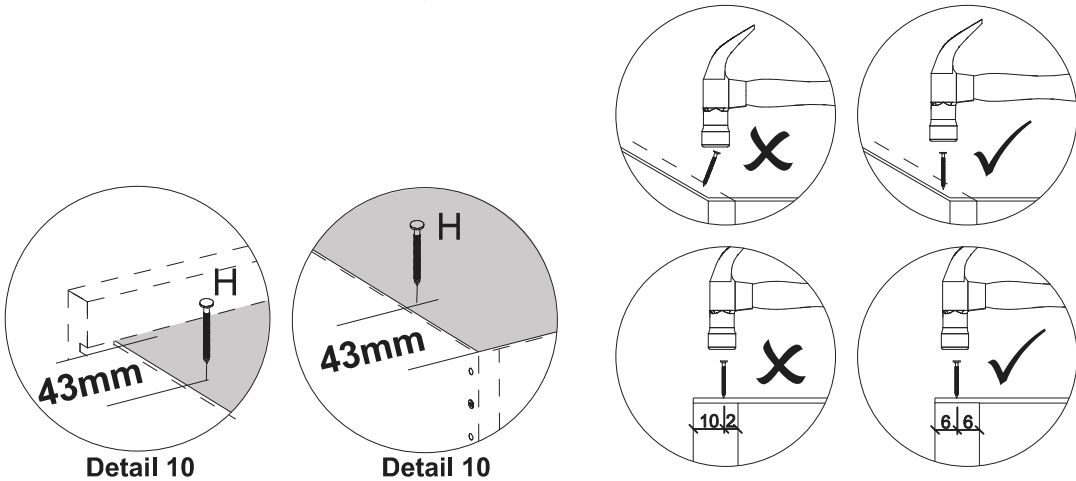
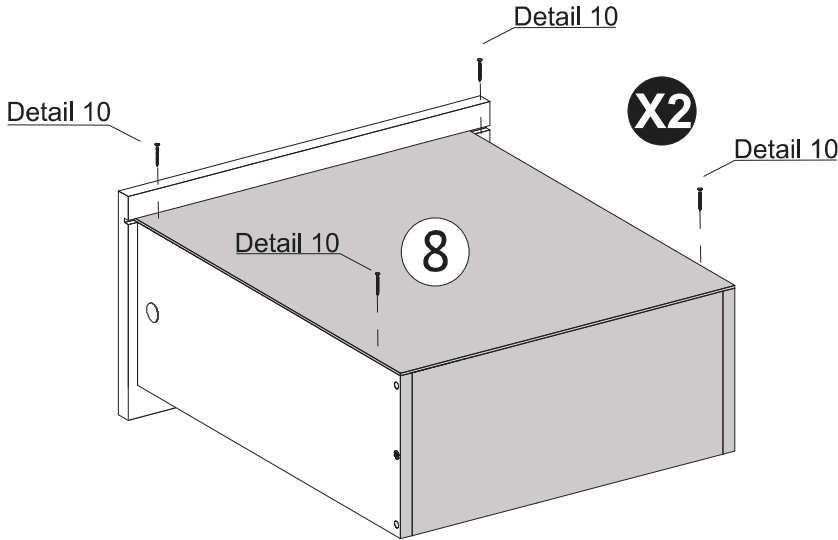
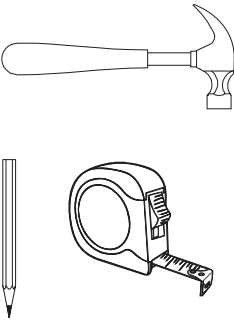

STEP 24

PARTS REQUIRED

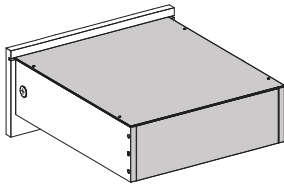

HARDWARE REQUIRED

H  08
10 x 10

TOOLS REQUIRED

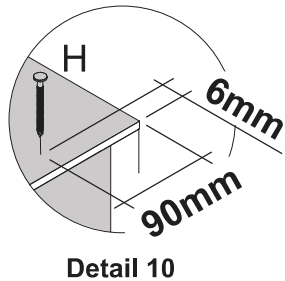
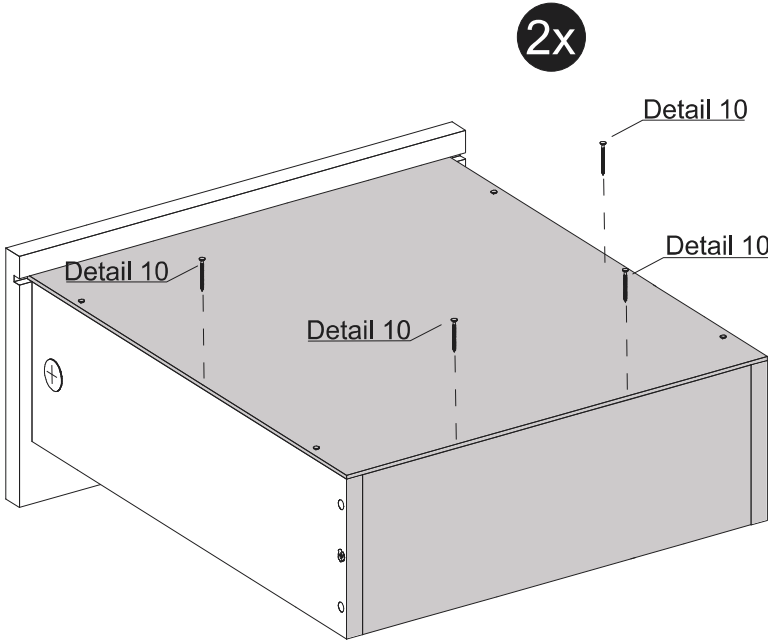
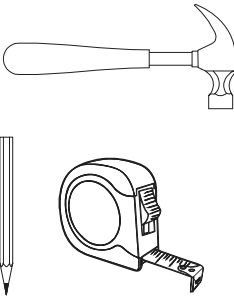

STEP 25

PARTS REQUIRED

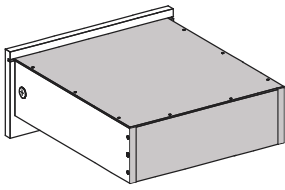

HARDWARE REQUIRED

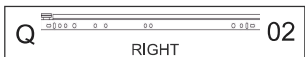
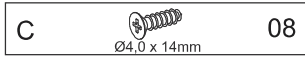

TOOLS REQUIRED

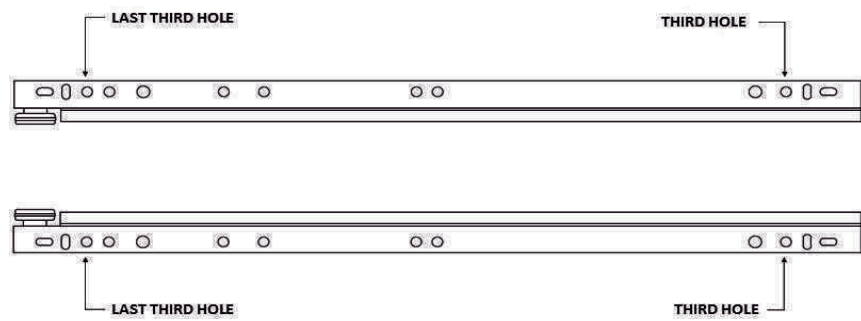
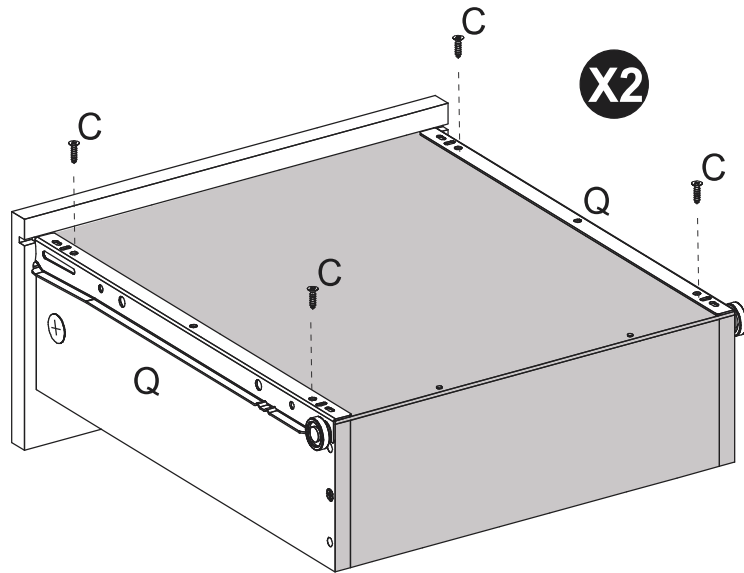
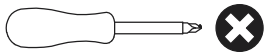

STEP 26

PARTS REQUIRED

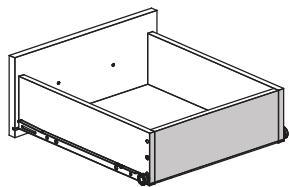

HARDWARE REQUIRED

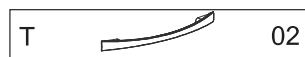
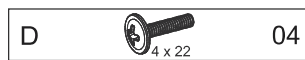

TOOLS REQUIRED

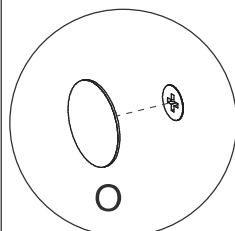
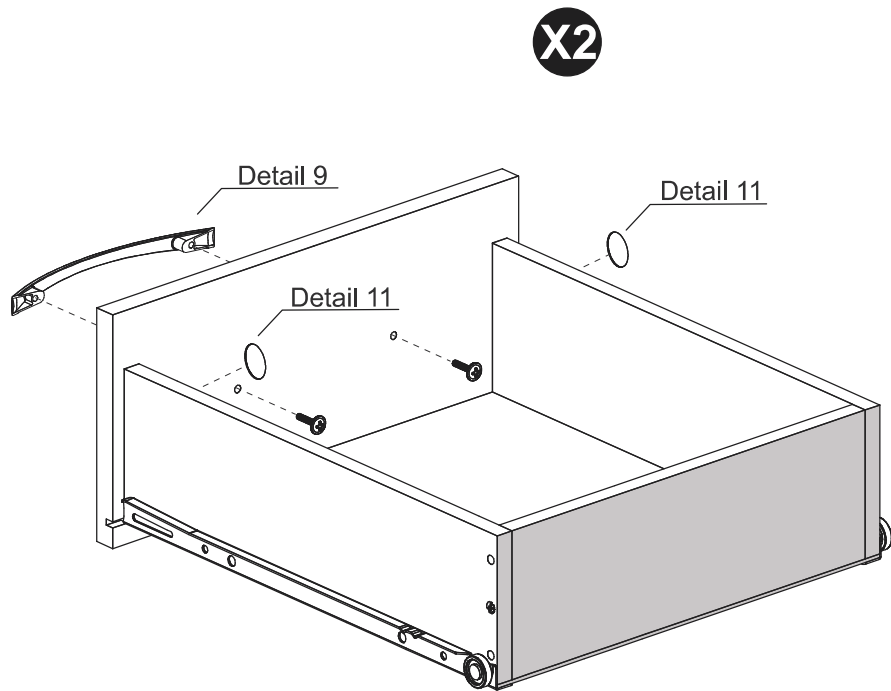
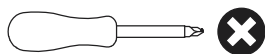

Detail 11

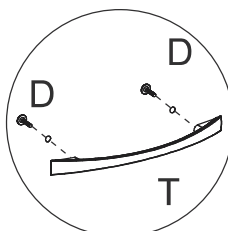

Detail 9

STEP 27

PARTS REQUIRED

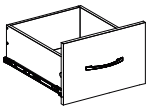
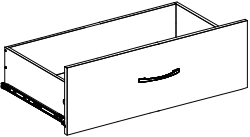
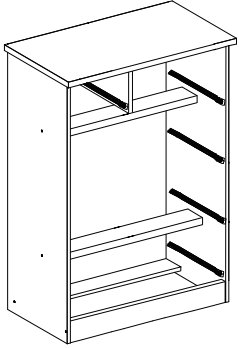

HARDWARE REQUIRED



TOOLS REQUIRED

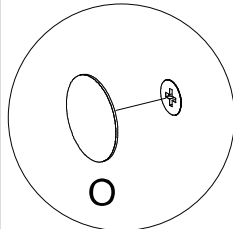
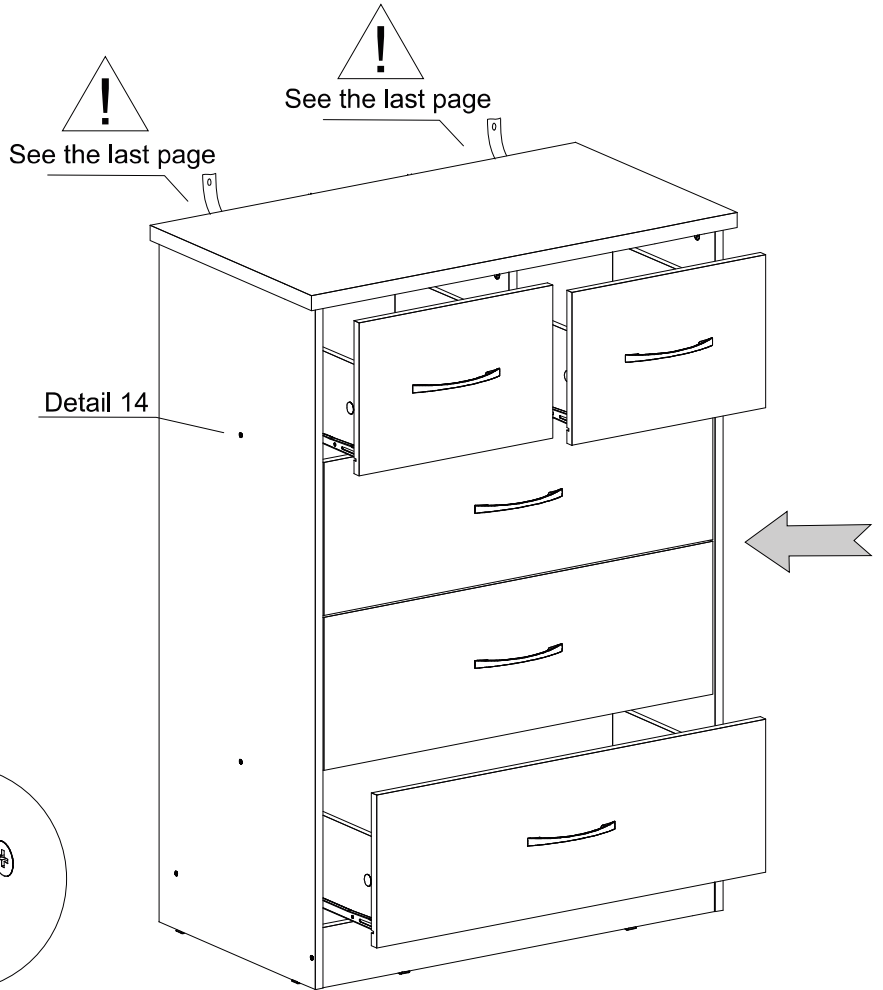

Detail 14

STEP 28

PARTS REQUIRED

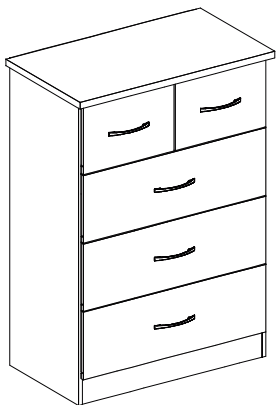

HARDWARE REQUIRED

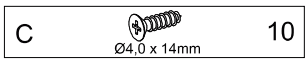

TOOLS REQUIRED

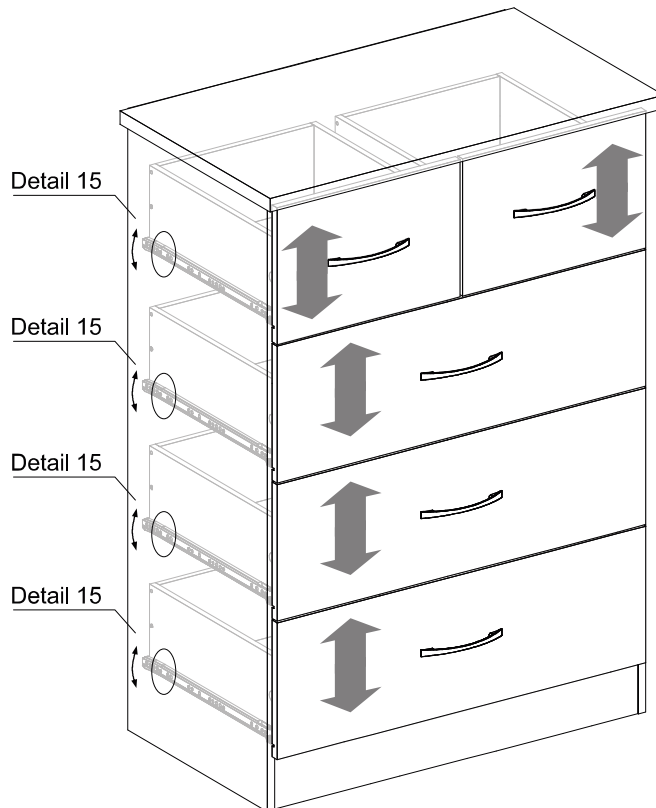

Drawer Adjustment

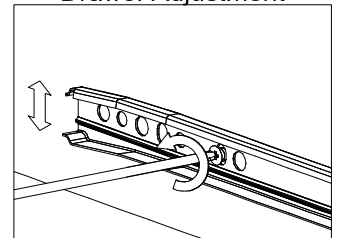

Right Side

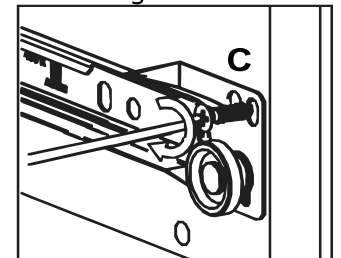

Left Side

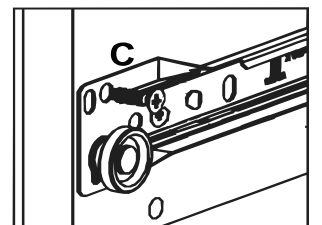

Detail 15

WARNING

Serious or fatal injuries can occur from furniture tipping over. To prevent the furniture from tipping over we recommend that it is permanently fixed to the wall.

Wall fixings are not supplied with this product as different wall materials require different types of fixing devices. Please make sure you use fixings suitable for the walls in your home.

