

NEVADA 6 DRAWER CHEST

ASSEMBLY INSTRUCTIONS

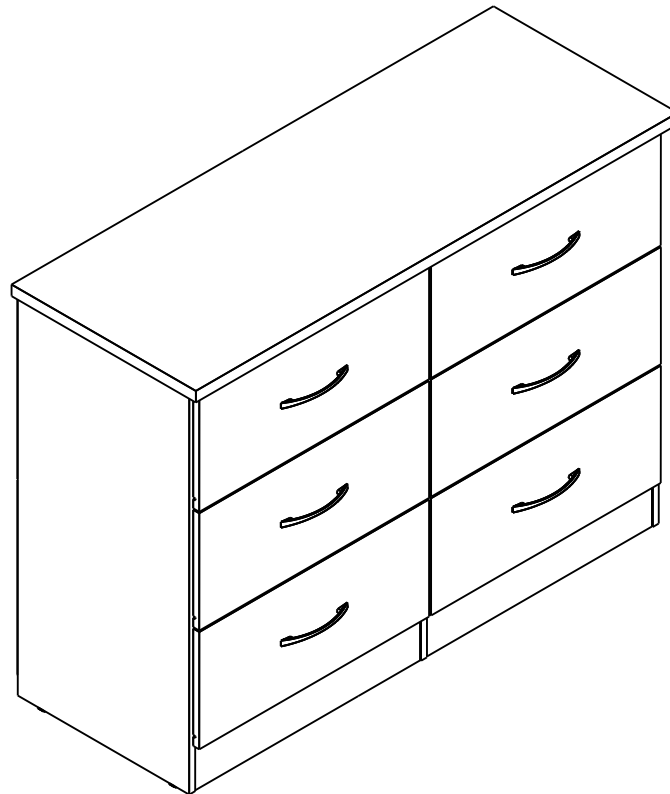

IMPORTANT
FOR DOMESTIC USE ONLY
PLEASE READ BEFORE YOU CONTINUE FURTHER

CARE AND MAINTENANCE

After unpacking this product please keep the original packaging in case it needs to be returned for any reason.

- Please ensure all fittings and parts are present before commencing with assembly.
- Never drag or push products as this could cause damage to the joints making it inferior.
- We strongly recommend that you keep children away from your work area.
- We recommend that you lay a blanket or sheet on the floor to avoid damage to both your floor and the product.
- Assemble this product as close to its final position as possible.
- Do not place this product next to a radiator or in direct sunlight.
- Do not drag or push items across your high gloss furniture as this may cause the surface to scratch
- Wood is a natural product and may expand if subjected to damp and may shrink or crack if subjected to heat. Therefore it is recommended that room temperature is maintained, with no sudden temperature fluctuations.
- Make sure any spillage is wiped off immediately.
- Do not place hot or chilled items directly on to the surface, use a place mat or marking will occur.
- For general cleaning use a soft cotton or micro fibre cloth, and do not use detergents of any kind.
- From time to time it may be necessary to tighten fittings, regular inspections should be carried out.
- Do not place on a wet or damp floor as staining may occur to your floor.



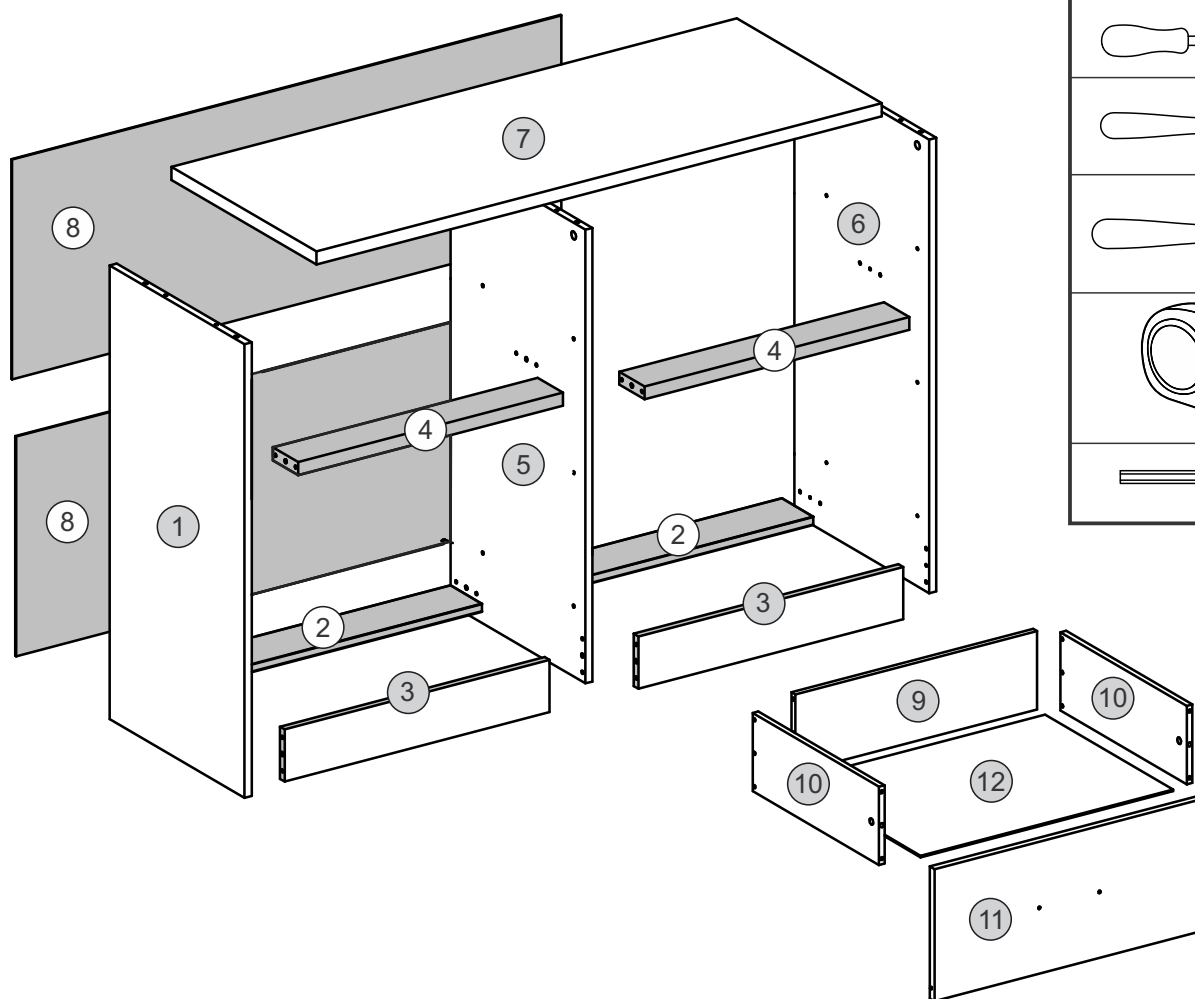
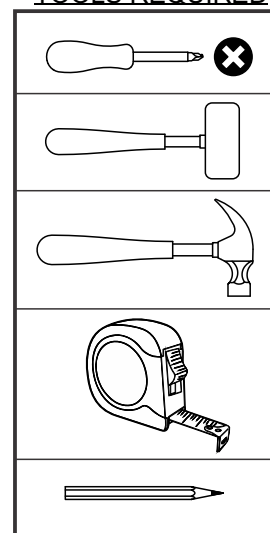



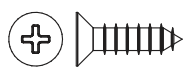
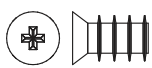
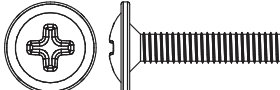

TOOLS REQUIRED

***Please Note:***

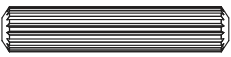
The below parts have all been stamped with the part number to help identify them during assembly.

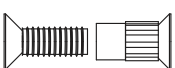
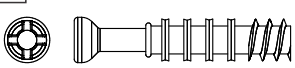
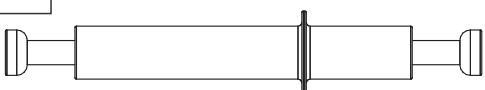
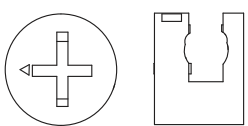
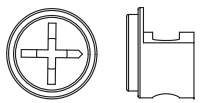
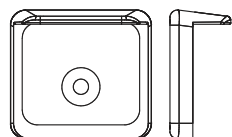
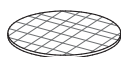
Part Number	Part Description	Quantity	Carton
01	Left Side Panel	1	1/2
02	Back Baseboard	2	1/2
03	Front Baseboard	2	1/2
04	Crossbar	2	1/2
05	Division Panel	1	1/2
06	Right Side Panel	1	1/2
07	Top Panel	1	2/2
08	Back Panel	2	2/2
09	Drawer Back Panel	6	1/2
10	Drawer Side	12	2/2
11	Drawer Front	6	2/2
12	Drawer Bottom	6	2/2

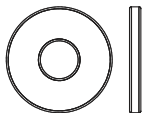

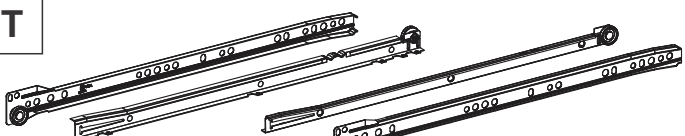
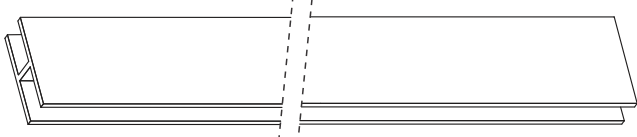
FITTINGS LIST

A  Flat Head Screw Ø4,0 x 14mm (36x) +/2	B  Flat Head Screw Ø6,0 x 10mm (12x) +/2	C  Flan Head Screw Ø4,0 x 20mm (12x) +/2	D  Flan Head Screw Ø3,5 x 30mm (2x) +/1
E  Flat Head Screw Ø4,0x 50mm (12x) +/2	F  Dowel Ø6,0 x 30mm (66x) +/2	G  Dowel Ø6,0 x 50mm (6x) +/1	
H  Nail 10 x 10 (116x) +/2	I  Double Flat Head Screw Ø4,0 x 18mm (6x) +/1	J  Cam Bolt (24x) +/2	K  Double Cam Bolt (3x) +/1
L  Cam Nut Ø15mm (18x) +/2	M  Cam Nut Ø12mm (12x) +/2	N  Plastic Foot (6x) +/1	O  Hole Plugs (12x) +/2
P  Glue (2x)	Q  Strap (2x)	R  Washer (4x) +/1	S  Handle (6x)
T  Drawer Runners (6x)	U  Back Panel Strip (1x)		

TIPS FOR FITTINGS CAM-LOCKS

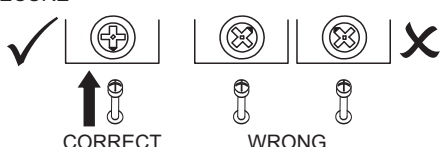
WHEN FITTING CAM NUT, ENSURE STARTING POSITION IS CORRECT BEFORE YOU INSERT CONNECTING CAM BOLT TURN CLOCKWISE UNTIL SECURE



 CORRECT  WRONG

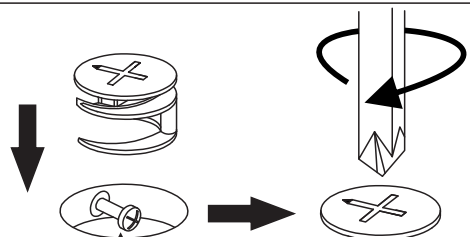

Cam bolt head needs to be in centre

CAMBOLT

Tighten until shoulder in flush with panel. Do not overtighten or undertighten (see example beside)

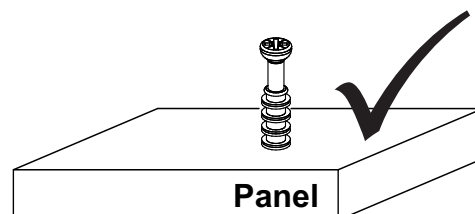
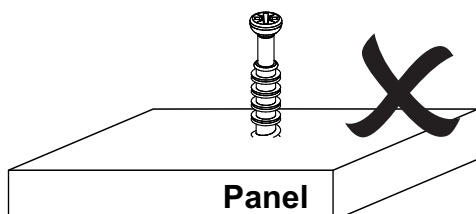
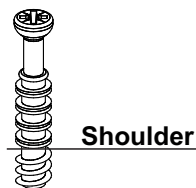



STEP 1

PARTS REQUIRED

2 - BACK BASEBOARD	x2
3 - FRONT BASEBOARD	x2
4 - CROSSBAR	x2

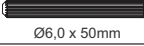
HARDWARE REQUIRED

F		12
G		06
P		01

TOOLS REQUIRED

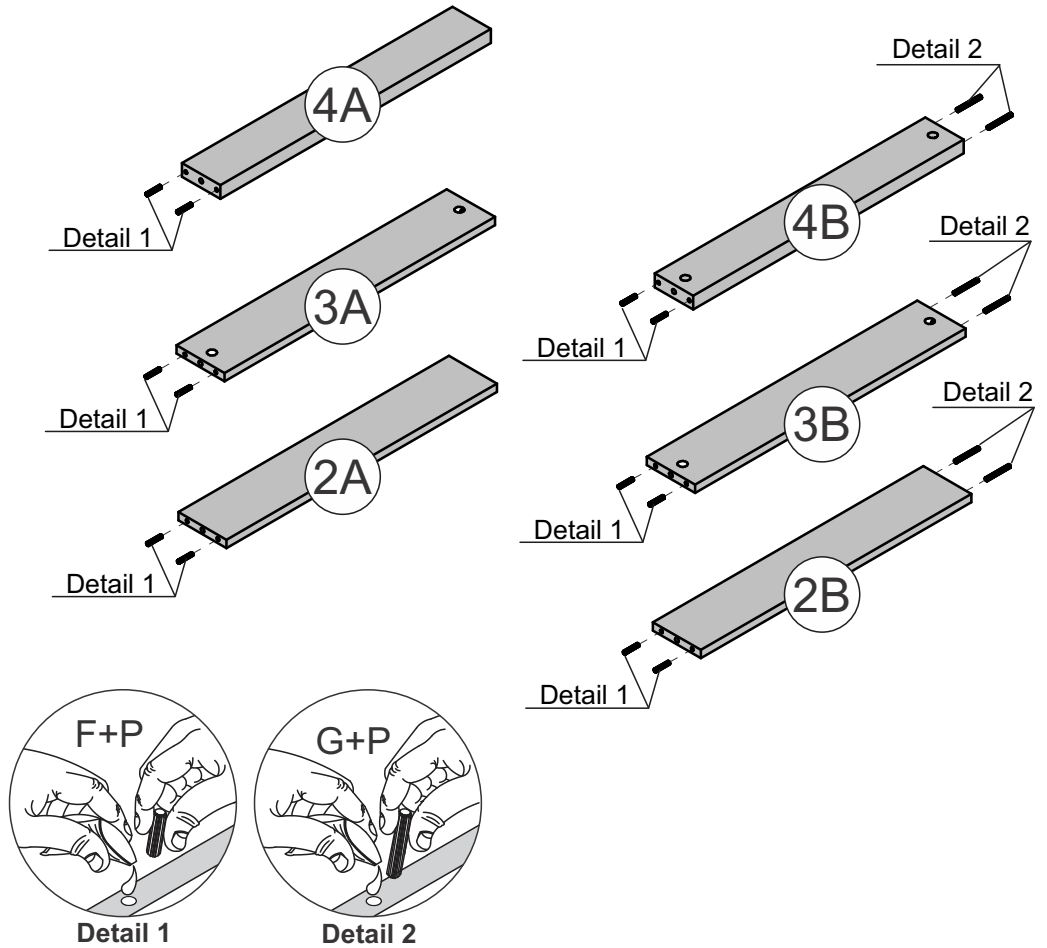
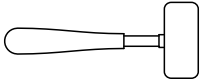

STEP 2

PARTS REQUIRED

7 - TOP PANEL	x1
---------------	----

HARDWARE REQUIRED

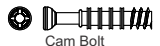
J		06
---	---	----

TOOLS REQUIRED

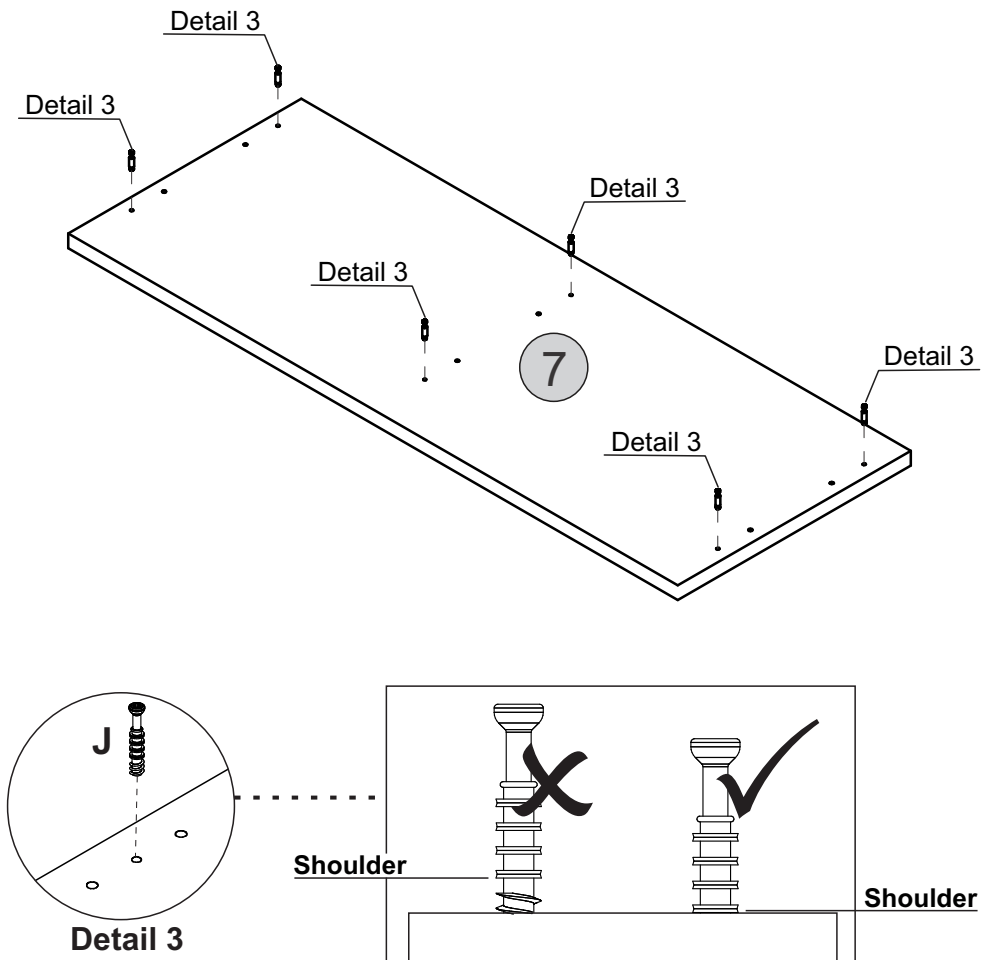
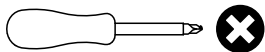

STEP 3

PARTS REQUIRED

6 - RIGHT SIDE PANEL x1

HARDWARE REQUIRED

B  06
Ø6,0 x 10mm

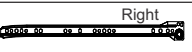
T  03
Right

TOOLS REQUIRED

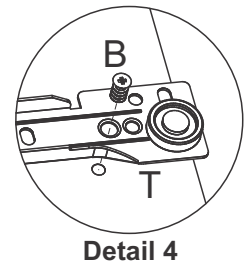
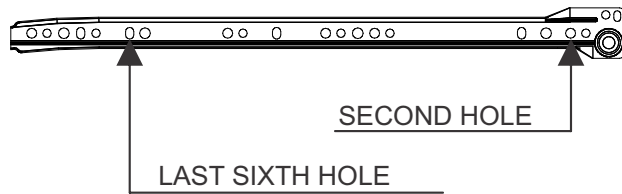
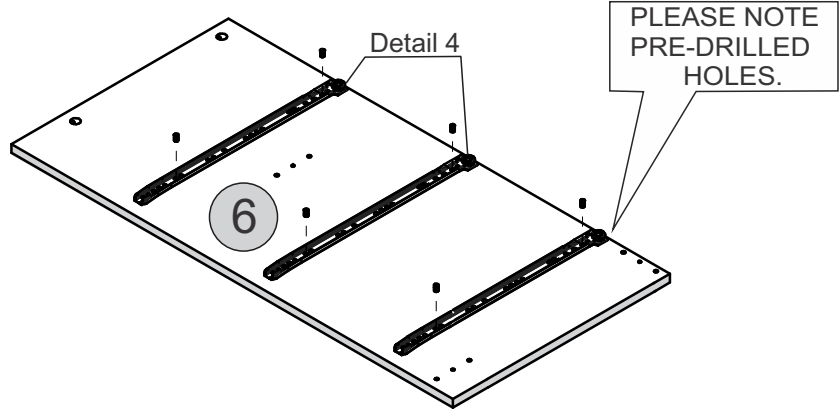
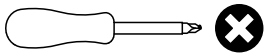

STEP 4

PARTS REQUIRED

1 - LEFT SIDE PANEL x1

HARDWARE REQUIRED

B  06
Ø6,0 x 10mm

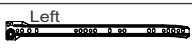
T  03
Left

TOOLS REQUIRED

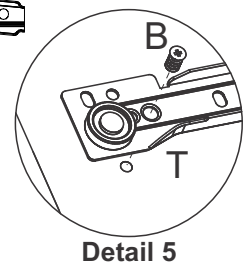
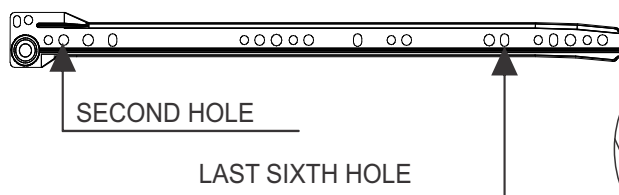
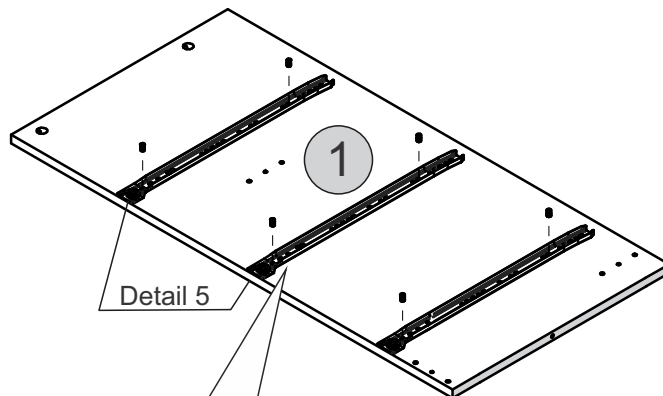
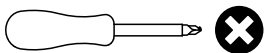



STEP 5

PARTS REQUIRED

5 - DIVISION PANEL x1

HARDWARE REQUIRED

I  06

T  Right 03

T  Left 03

TOOLS REQUIRED

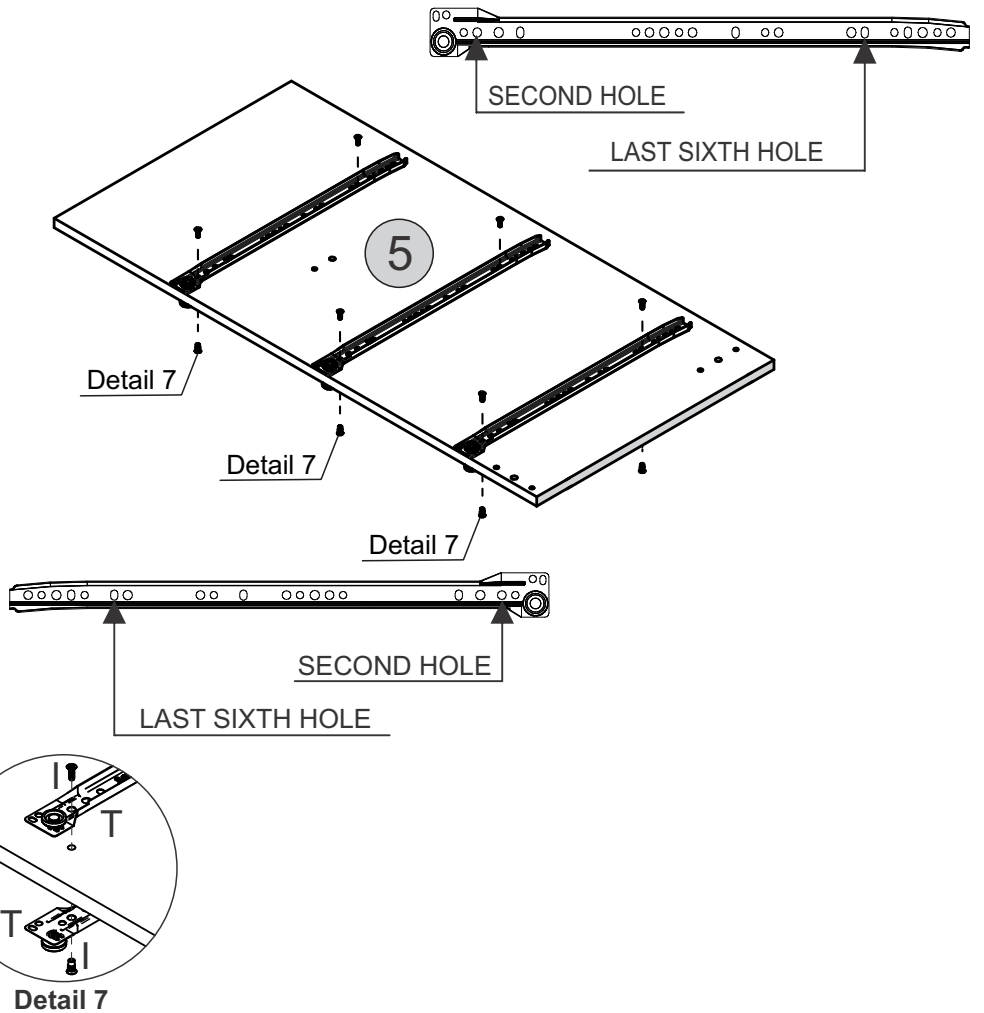
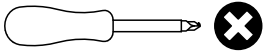

STEP 6

PARTS REQUIRED

5 - DIVISION PANEL x1

HARDWARE REQUIRED

F  Ø6,0 x 30mm 02

H  02

N  02

P  Glue 01

TOOLS REQUIRED

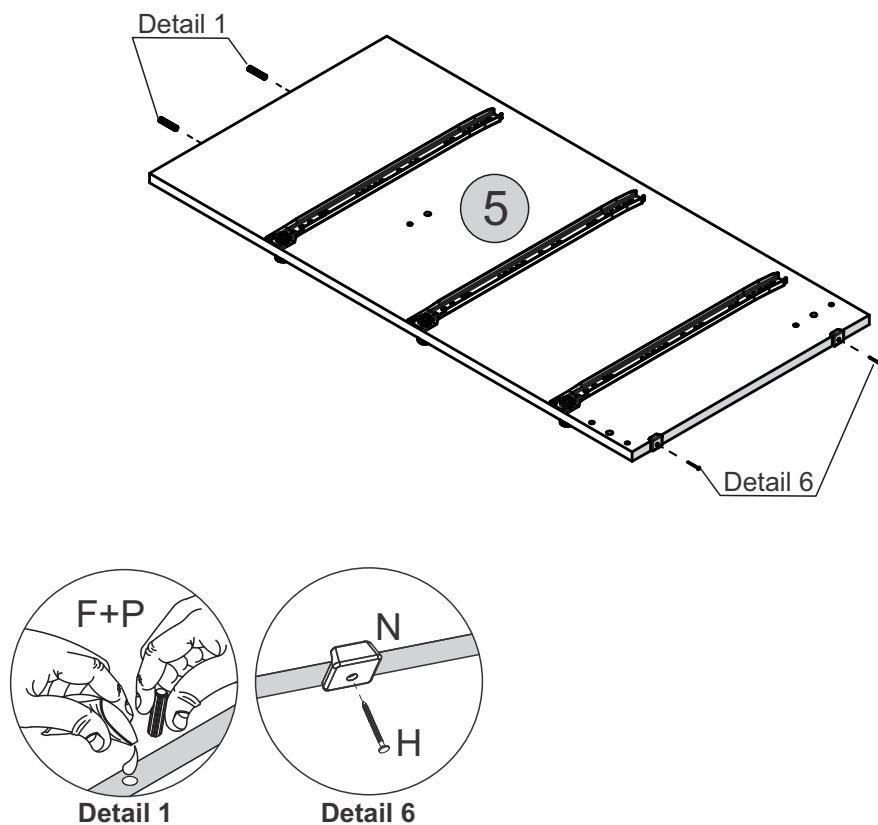
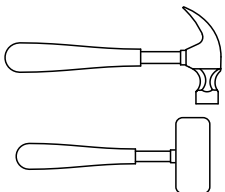

STEP 7

PARTS REQUIRED

1 - LEFT SIDE PANEL x1

6 - RIGHT SIDE PANEL x1

HARDWARE REQUIRED

F  04
Ø6,0 x 30mm

H  04

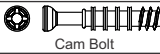
J  06
Cam Bolt

N  04

P  01
Glue

TOOLS REQUIRED

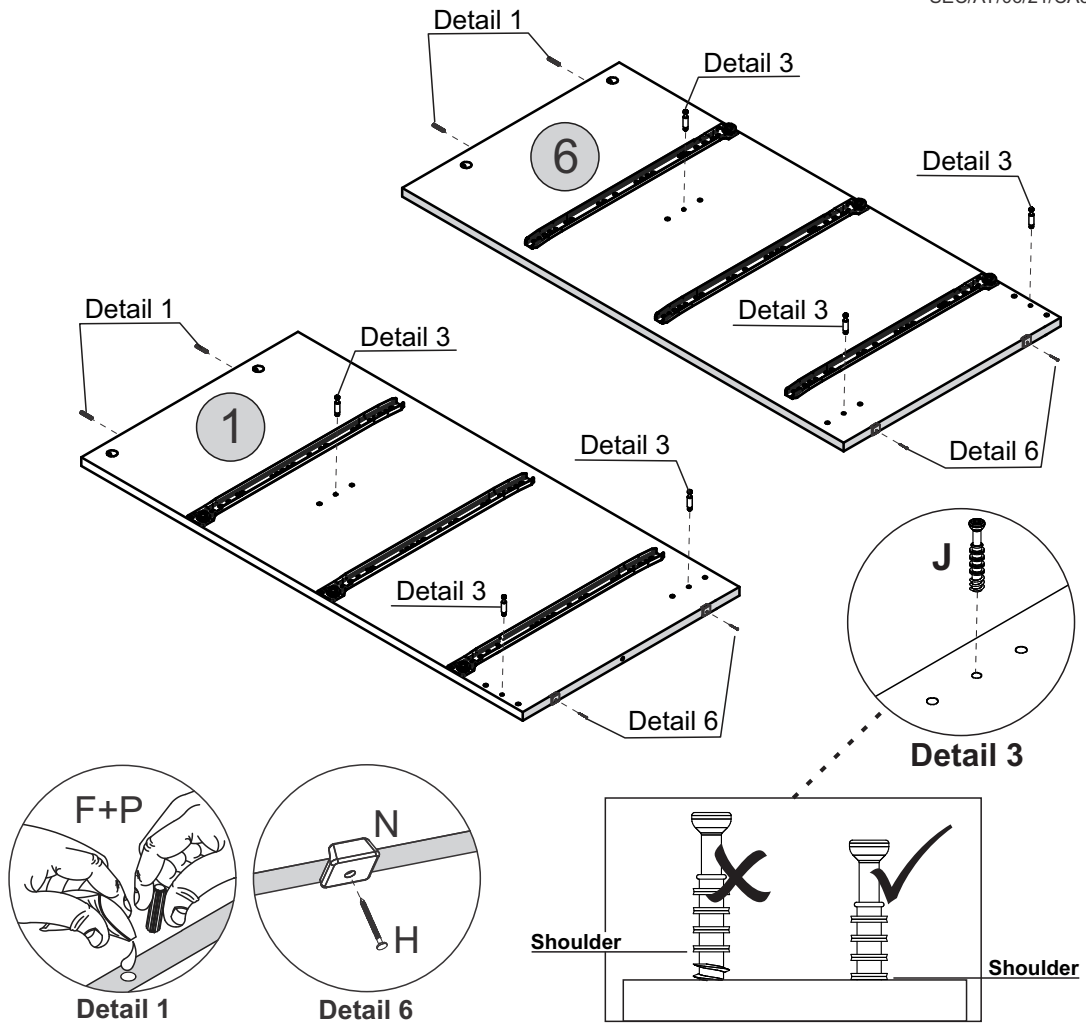
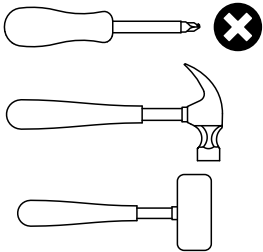

STEP 8

PARTS REQUIRED

2 - BACK BASEBOARD x2

3 - FRONT BASEBOARD x2

4 - CROSSBAR x2

5 - DIVISION PANEL x1

HARDWARE REQUIRED

K  03

L  06

P  01
Glue

TOOLS REQUIRED

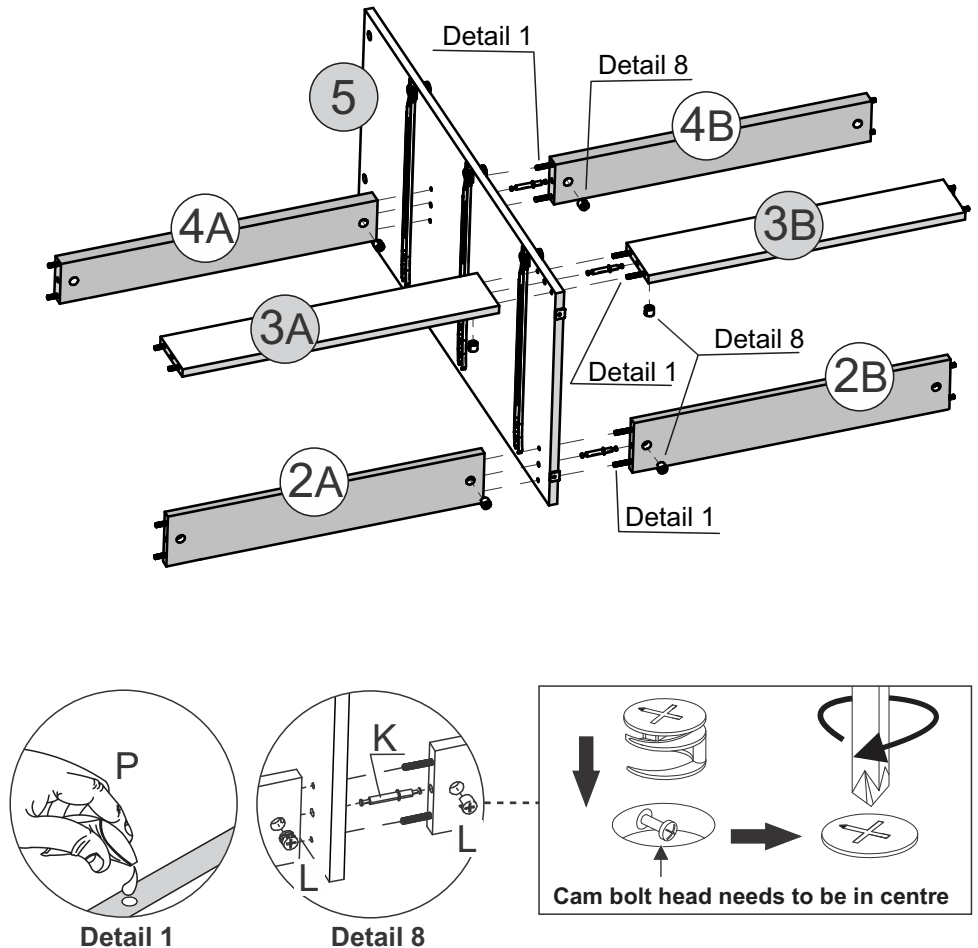
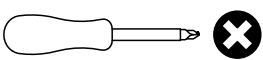

STEP 9

PARTS REQUIRED

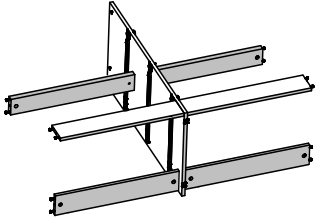

- 1 - LEFT SIDE PANEL x1
- 6 - RIGHT SIDE PANEL x1

HARDWARE REQUIRED

- L 06
- P 01

TOOLS REQUIRED

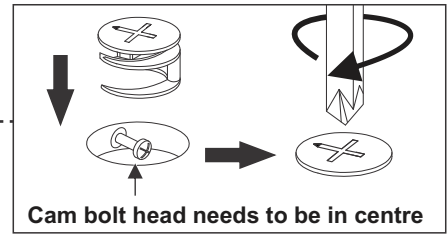
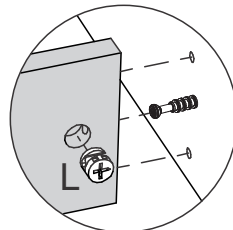
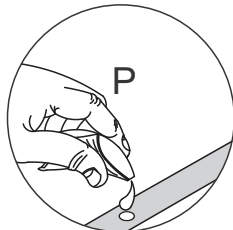
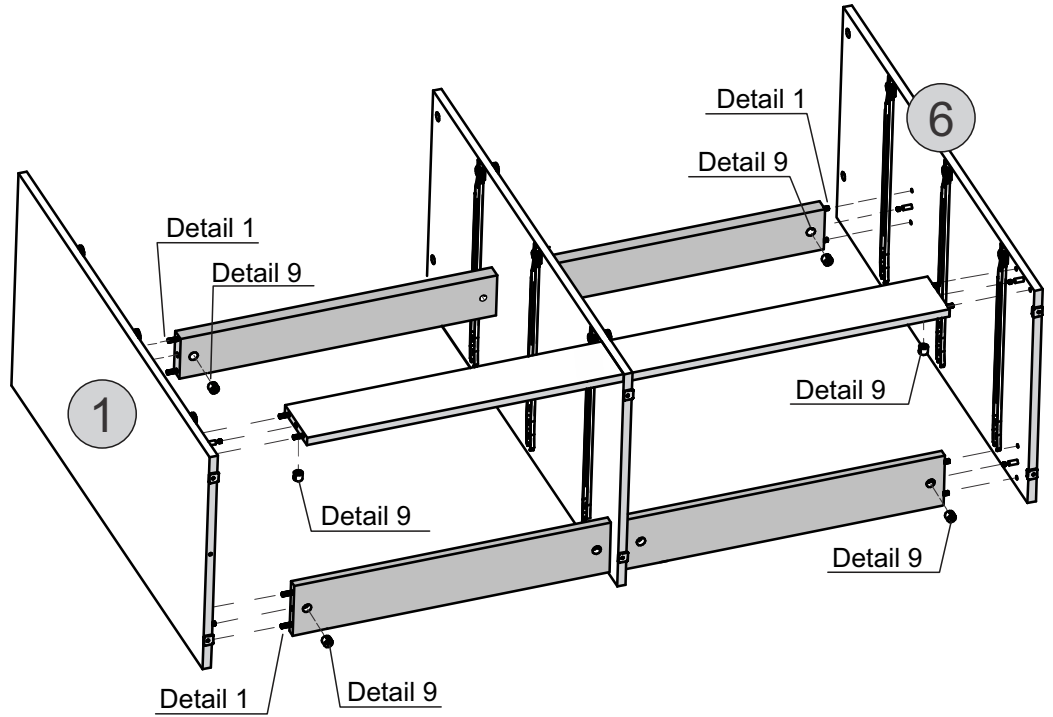
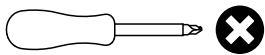

Detail 1

Detail 9

STEP 10

PARTS REQUIRED

- 7 - TOP PANEL x1

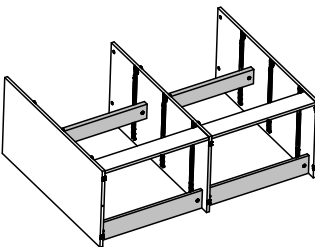

HARDWARE REQUIRED

- L 06
- P 01

TOOLS REQUIRED

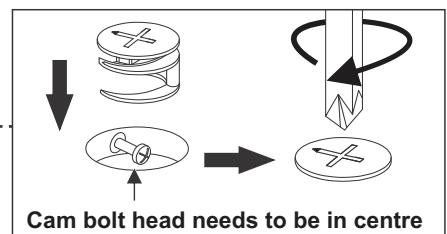
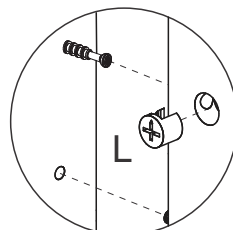
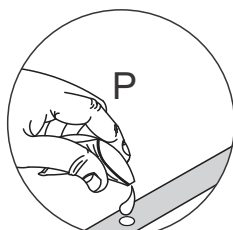
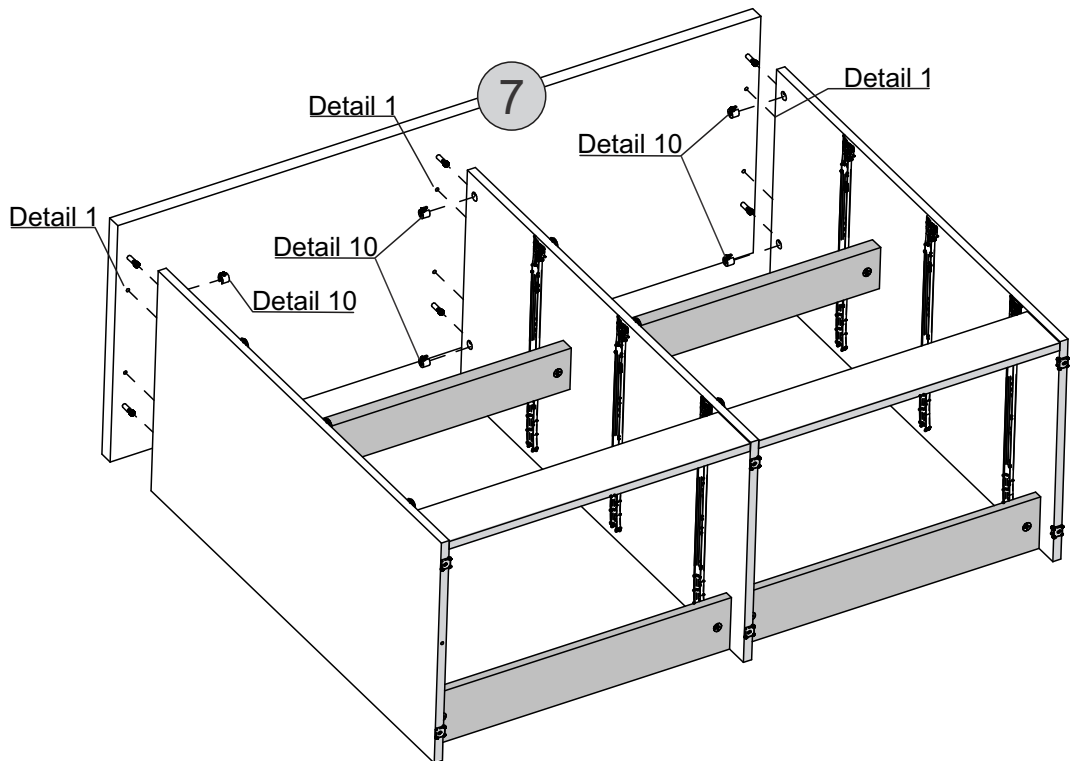
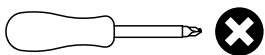

Detail 1

Detail 10

STEP 11

PARTS REQUIRED

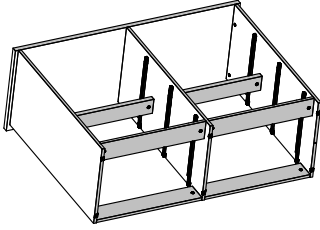

8 - BACK PANEL x2

HARDWARE REQUIRED

H  46

U  01

TOOLS REQUIRED

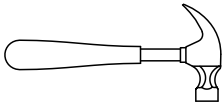

* For your future reference
Order Number should be here

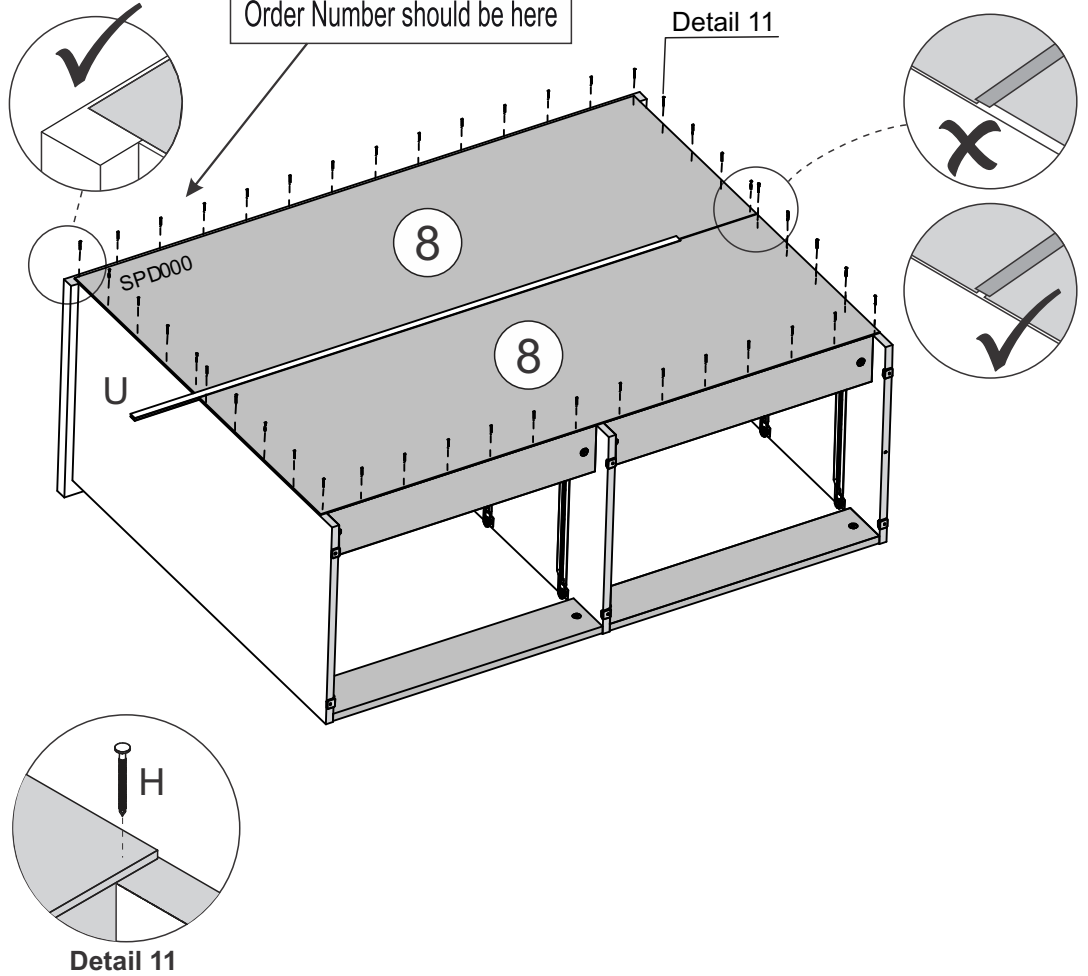

STEP 12

PARTS REQUIRED

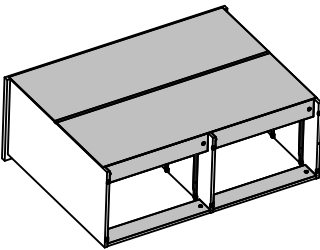

HARDWARE REQUIRED

H  10

TOOLS REQUIRED

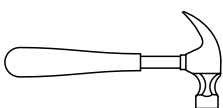

* For your future reference
Order Number should be here

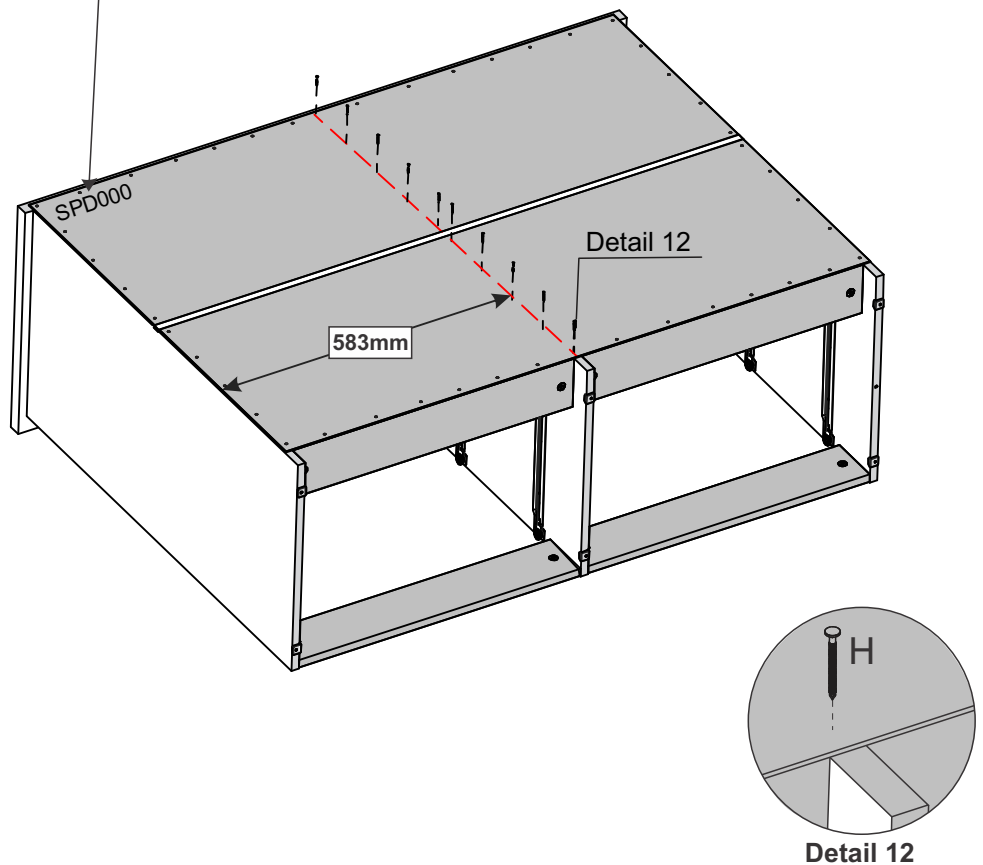

STEP 13

PARTS REQUIRED

11 - DRAWER FRONT x6

HARDWARE REQUIRED

J  12

TOOLS REQUIRED

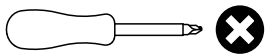

X6

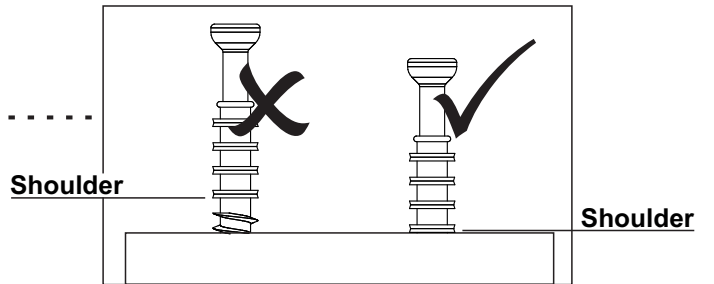
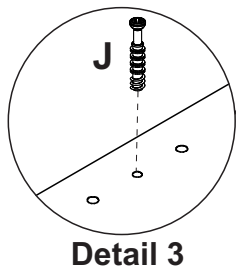
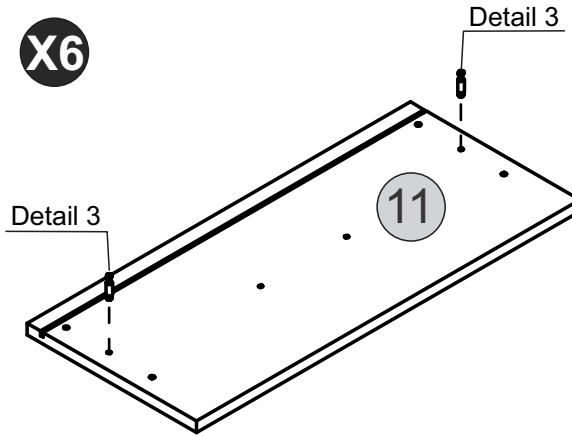

STEP 14

PARTS REQUIRED

9 - DRAWER BACK PANEL x6

10 - DRAWER SIDE x12

HARDWARE REQUIRED

F  48
Ø6,0 x 30mm

P  01
Glue

TOOLS REQUIRED

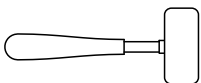

X12

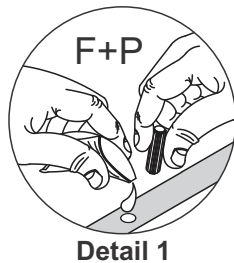
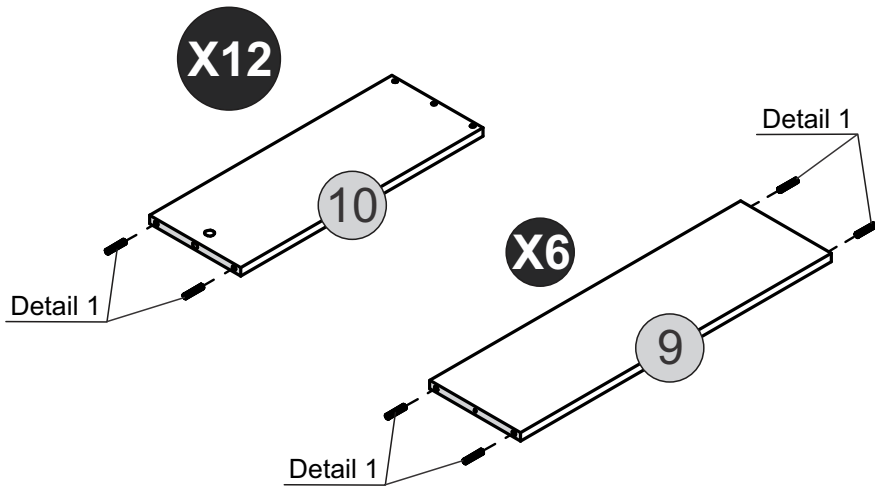

STEP 15

PARTS REQUIRED

9 - DRAWER BACK PANEL x6

10 - DRAWER SIDE x12

HARDWARE REQUIRED

E  12
Ø4.0 x 50mm

TOOLS REQUIRED

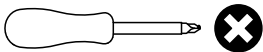

X6

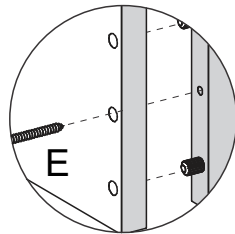
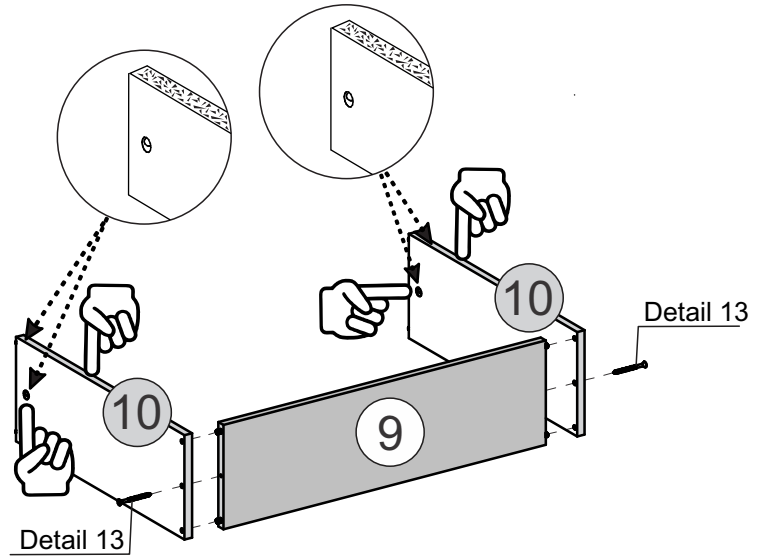

Detail 13

STEP 16

PARTS REQUIRED

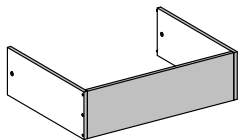

11 - DRAWER FRONT x6

HARDWARE REQUIRED

M  12

O  12

P  01

TOOLS REQUIRED

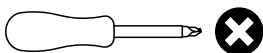

X6

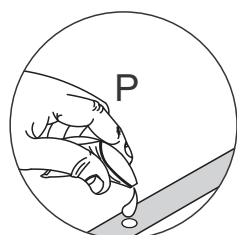
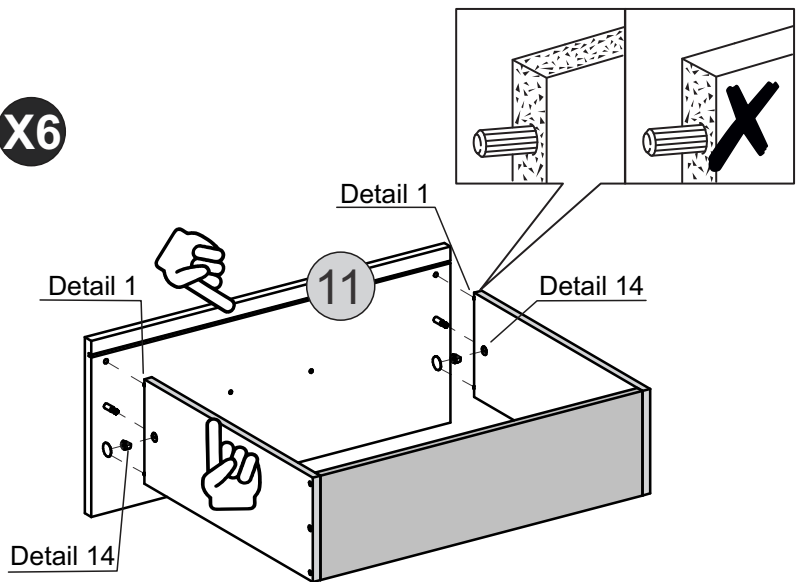

Detail 1

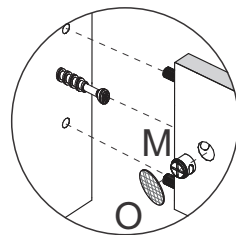

Detail 14

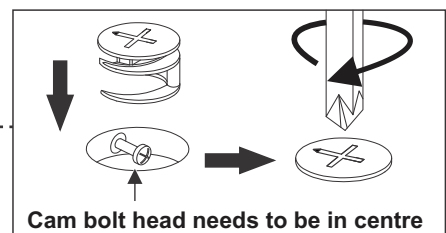

STEP 17

PARTS REQUIRED

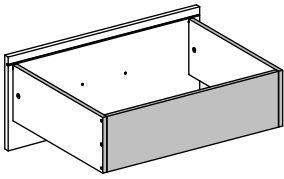

12 - DRAWER BOTTOM x6

HARDWARE REQUIRED

H  24
10 x 10

TOOLS REQUIRED

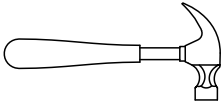

X6

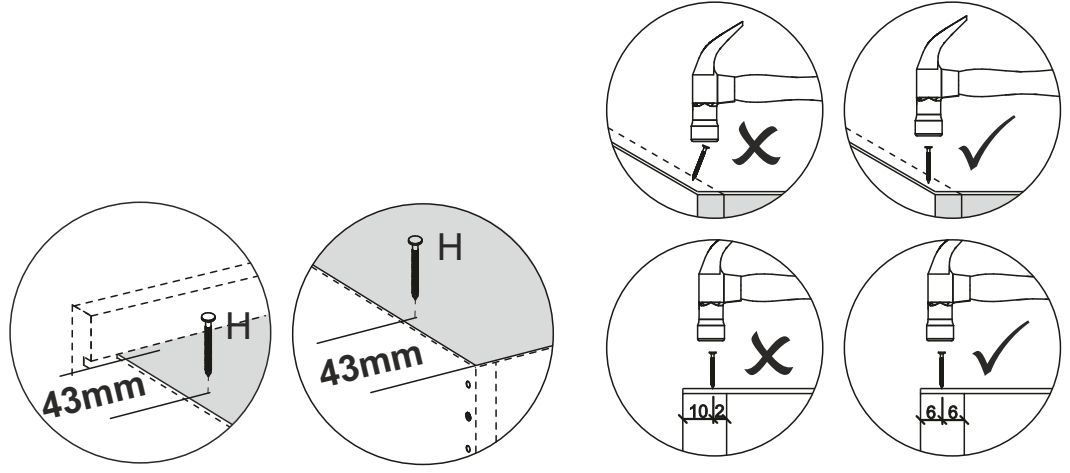
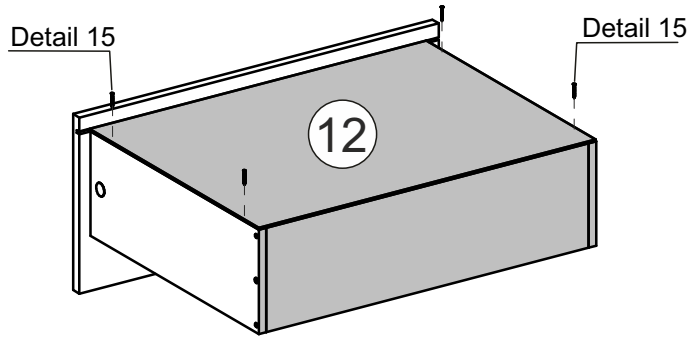

Detail 15

STEP 18

PARTS REQUIRED

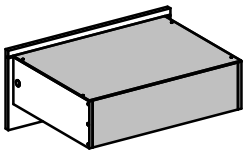

HARDWARE REQUIRED

H  30
10 x 10

TOOLS REQUIRED

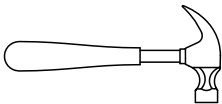

X6

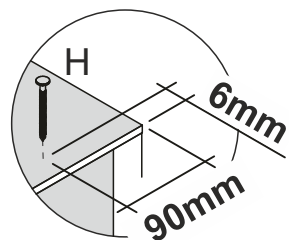
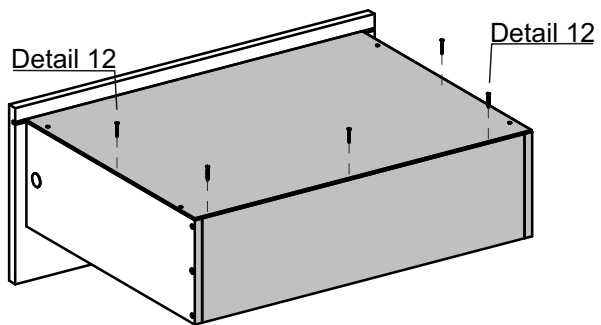

Detail 12

STEP 19

PARTS REQUIRED

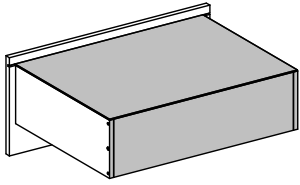

HARDWARE REQUIRED

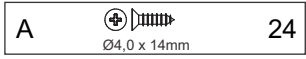

TOOLS REQUIRED

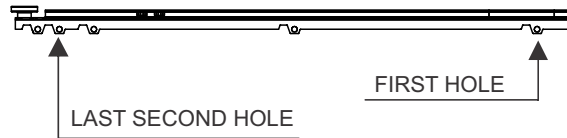
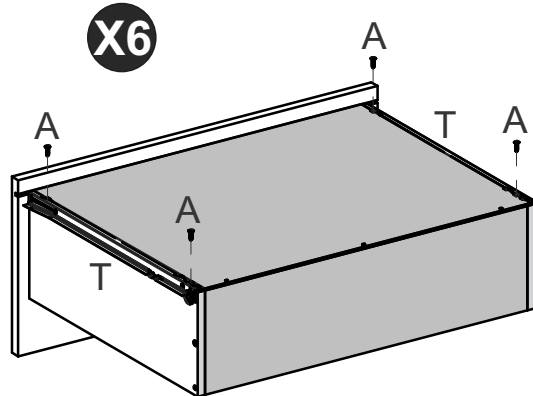
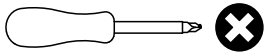

STEP 20

PARTS REQUIRED

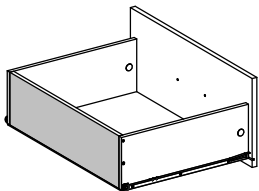

HARDWARE REQUIRED



TOOLS REQUIRED

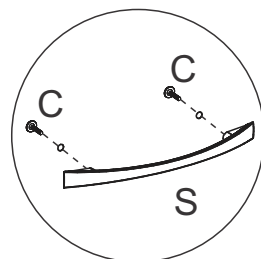
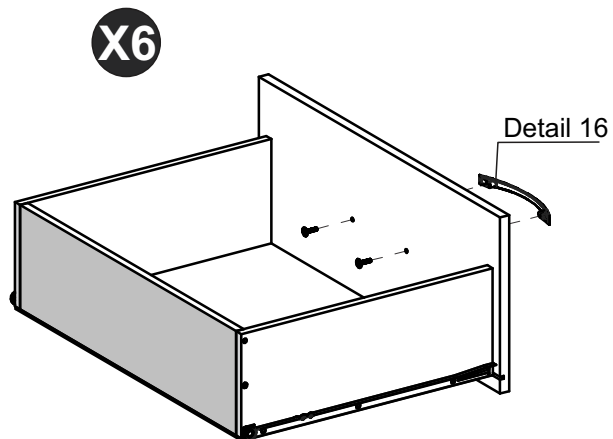
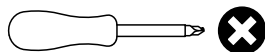

Detail 16

STEP 21

PARTS REQUIRED

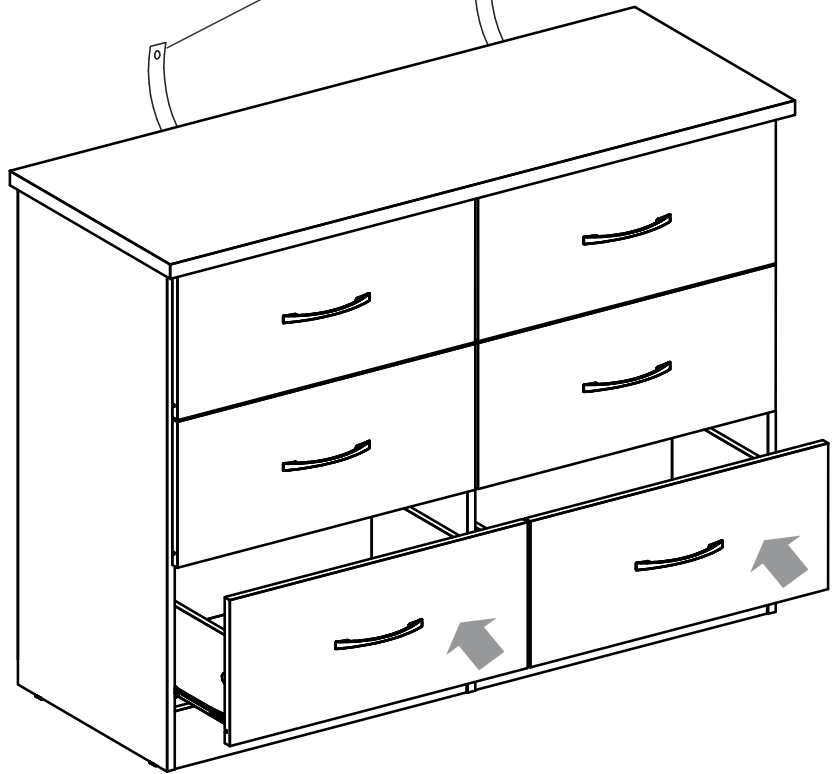
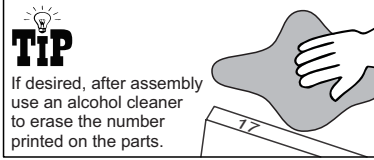
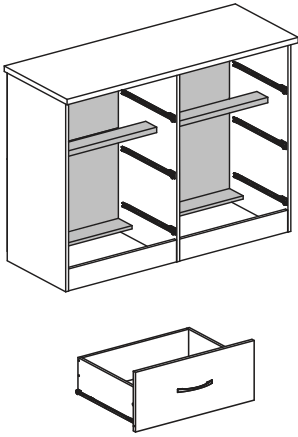

STEP 22

PARTS REQUIRED

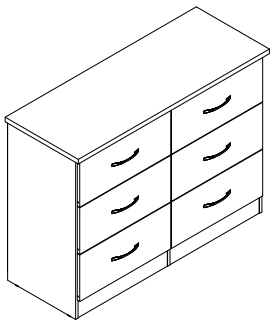

HARDWARE REQUIRED

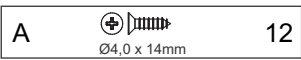

TOOLS REQUIRED

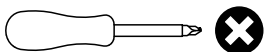

Detail 17

Detail 17

Detail 17

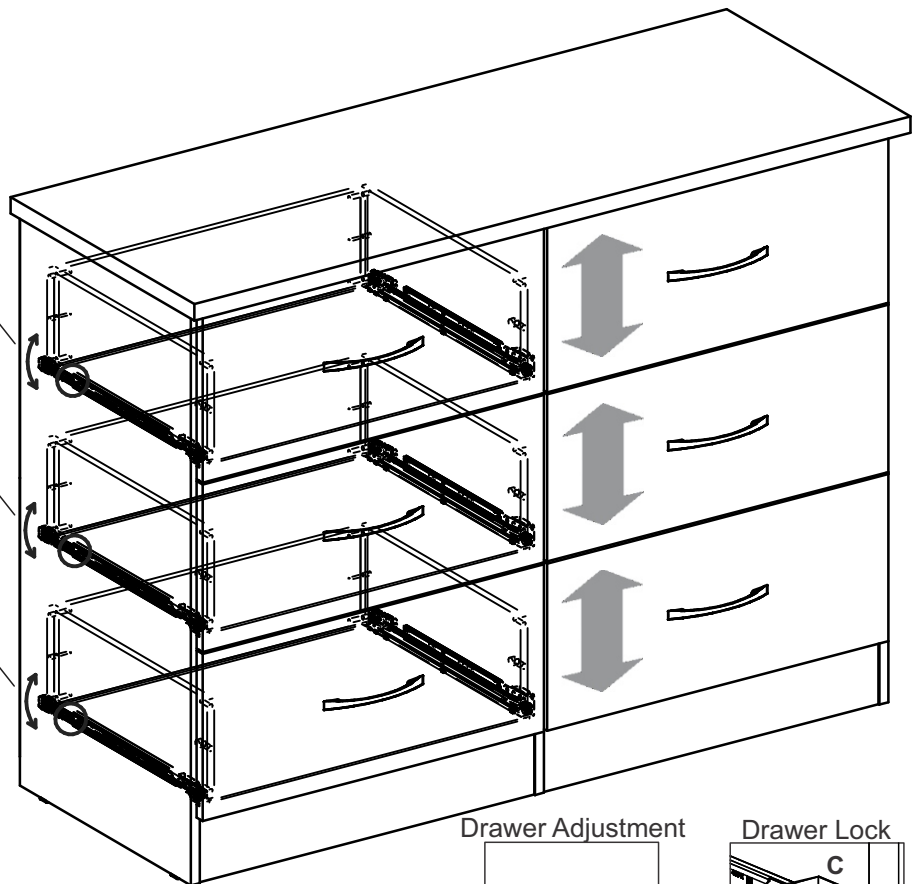

Drawer Adjustment

Drawer Lock

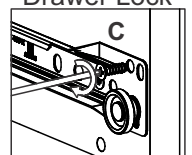
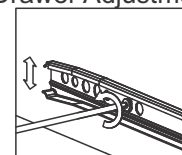

Detail 17

WARNING

Serious or fatal injuries can occur from furniture tipping over. To prevent the furniture from tipping over we recommend that it is permanently fixed to the wall.

Wall fixings are not supplied with this product as different wall materials require different types of fixing devices.

Please make sure you use fixings suitable for the walls in your home.

