

# 210 SERIES

## 4 Drawer Chest

### Assembly Instruction

!!Please take time to read and follow these instructions carefully!!

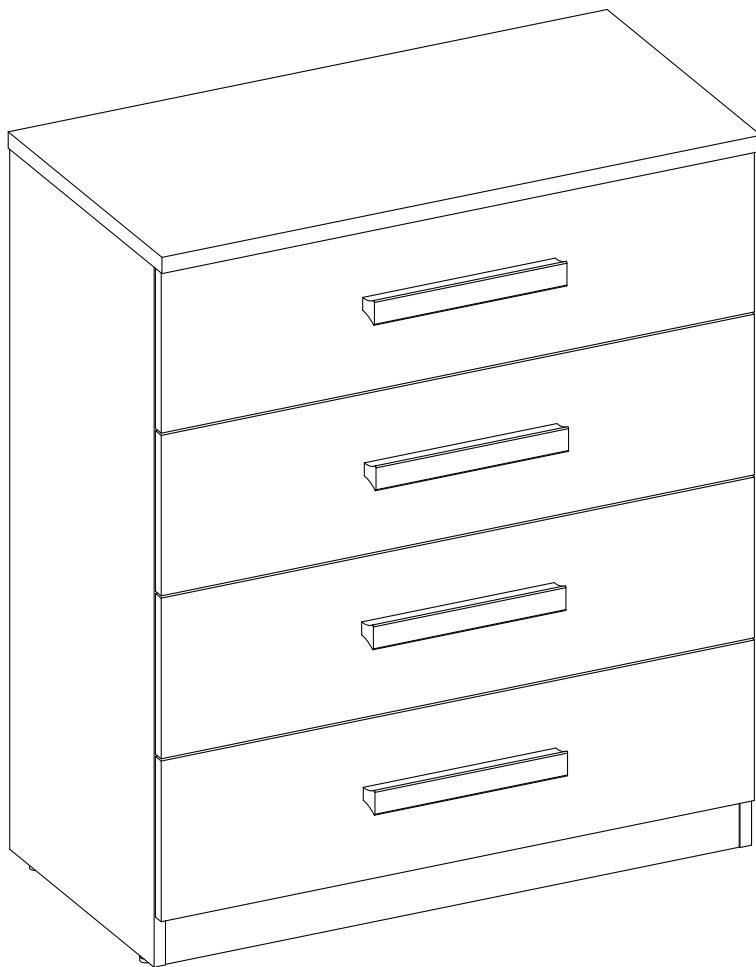

Version A

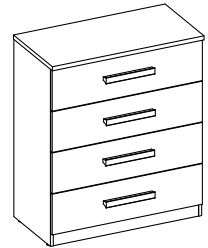

Version B

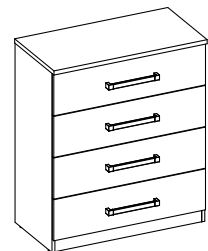

# Hello,

Thank you for choosing this item of furniture. To ensure that you get the most from your furniture here are a few safety tips and helpful hints from the professionals.

## **Safety**

- Keep children and animals away from the assembly area.
- This furniture contains small parts that could cause choking if swallowed.
- Where applicable ensure the unit is fixed to a wall.
- Ensure all packaging is disposed of responsibly.

## **Helpful Hints**

- Take time to read through the Assembly Instructions.
- Clear as much space as possible in the room you intend to use the furniture in. Assemble the furniture in that room, moving built furniture between rooms is hard work.
- Open the fittings bag into a washing-up bowl or other container to stop any small parts being lost.
- Check all fittings and panels against the parts list to ensure that you have everything before you start.
- Check that you have the recommended tools for assembly. The use of power tools is NOT advised.
- Building is NOT a race. Take your time. For larger items take a break after about 60mins then start again refreshed.

## **Care and maintenance**

- To clean wipe with a slightly damp clean cloth.
- Periodically check there are no loose screws or fittings.

# Enjoy your furniture.

PART	SIZE mm	QTY
1	944x400x16	1
2	944x400x16	1
3	830x430x22	1
4	796x399x16	1
5	796x65x16	1
6	822x216x16	4
7	350x120x12	4
8	350x120x12	4
9	764x105x12	4
10	774x357x3	4
11	873x402x3	1
12	873x402x3	1

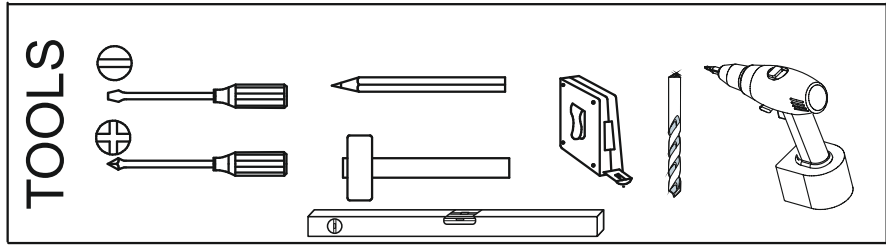



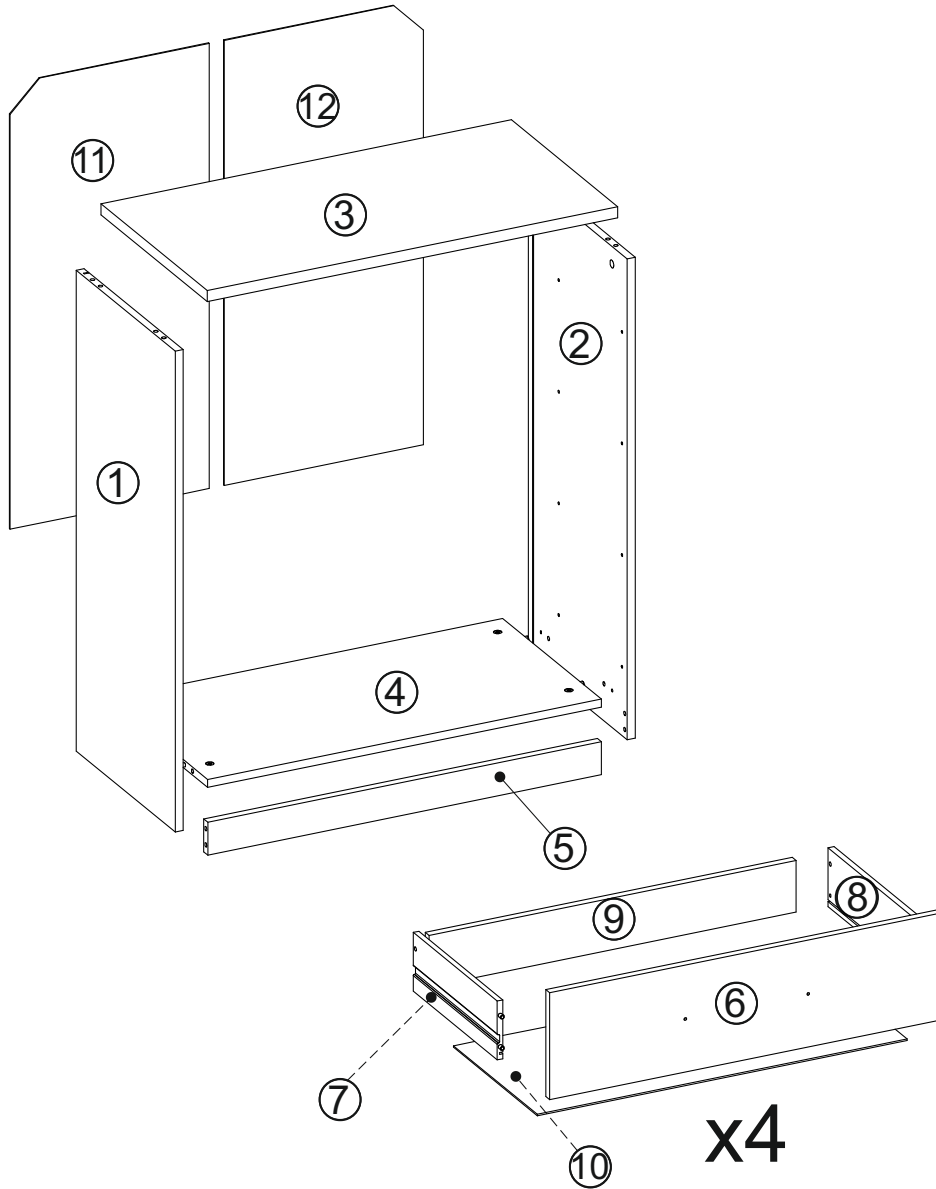

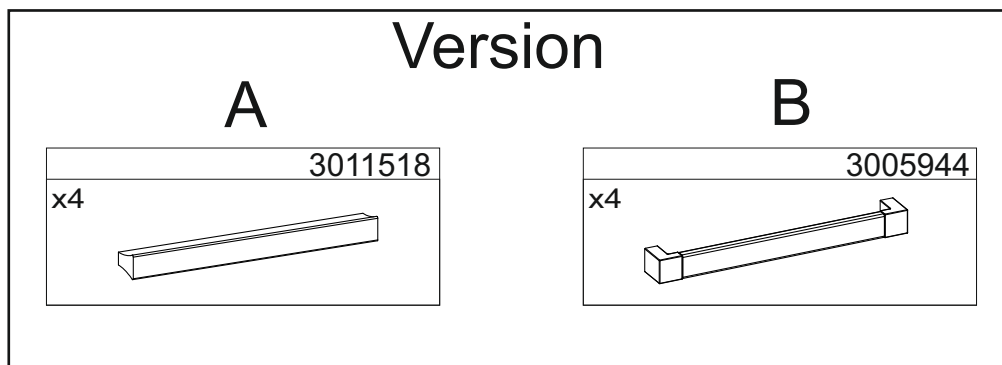
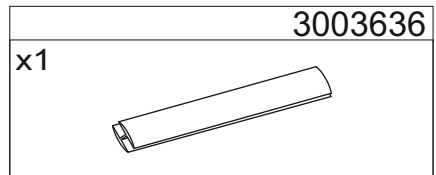
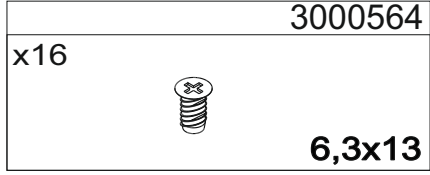
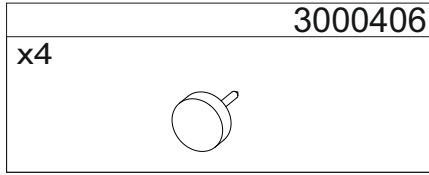
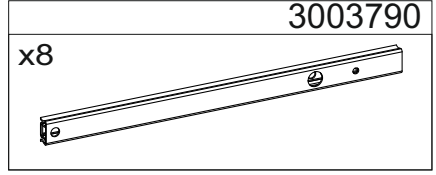
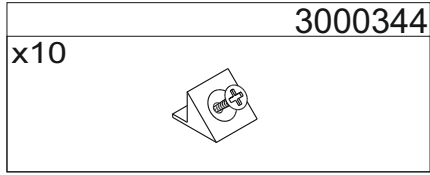
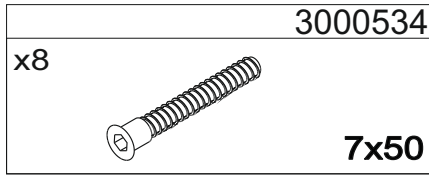
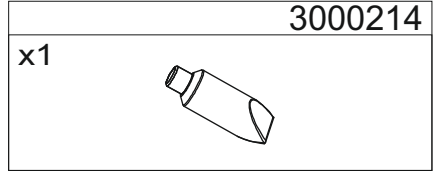
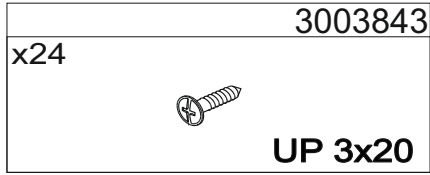
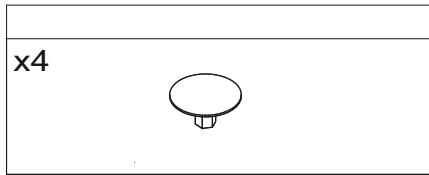
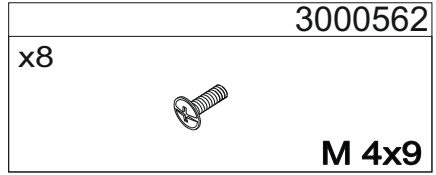
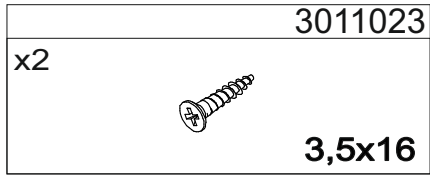
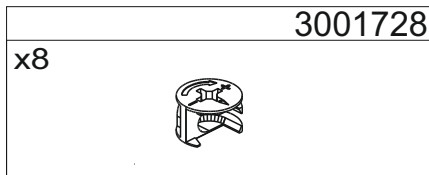
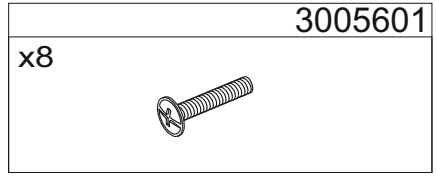
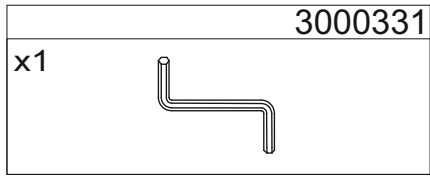
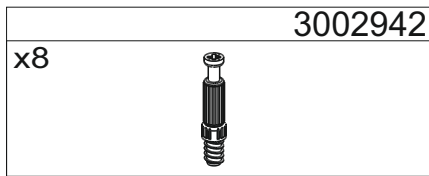
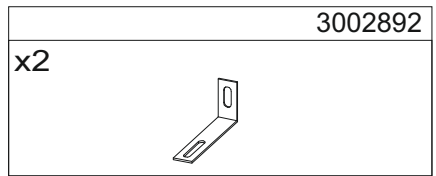
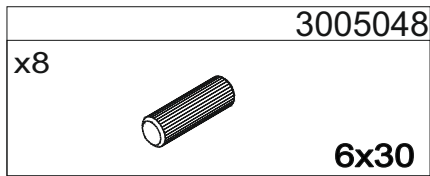
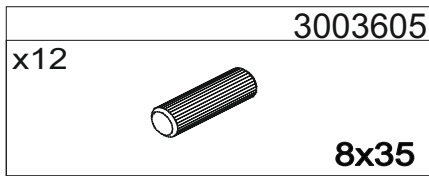

Installation shall be carried out exactly according to the manufacturer's instructions-otherwise a safety risk can occur if incorrectly installed; **WARNING** In order to prevent overturning this product must be used with the wall attachment device provided.





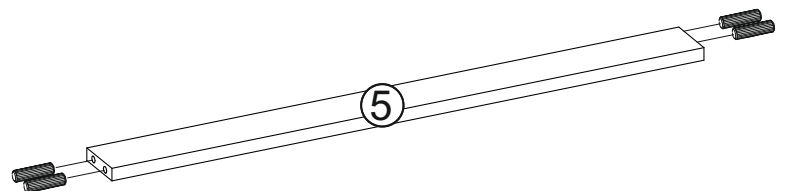
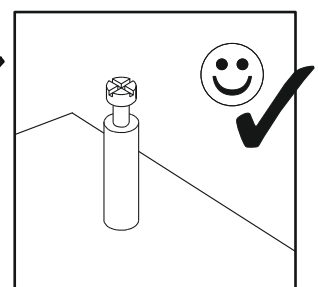
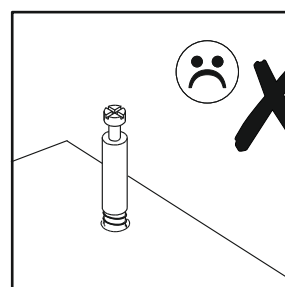
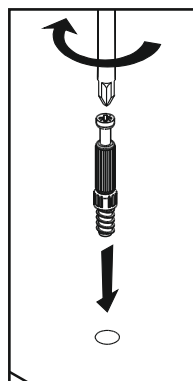
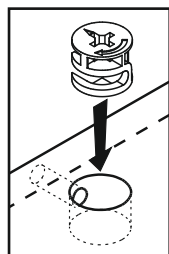
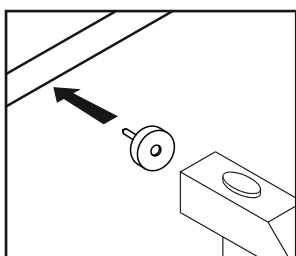
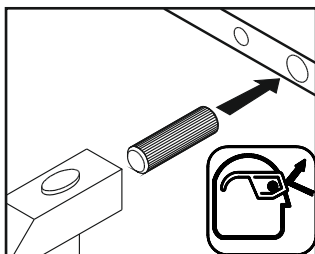
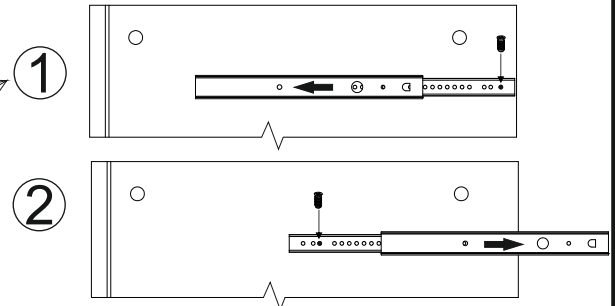
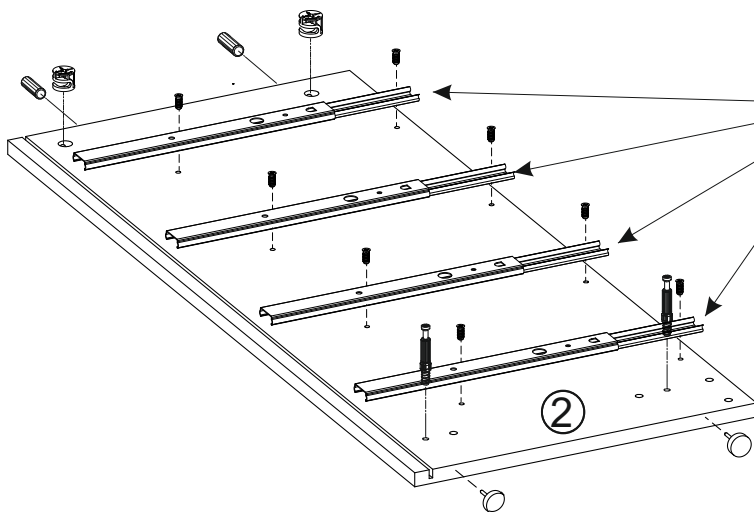
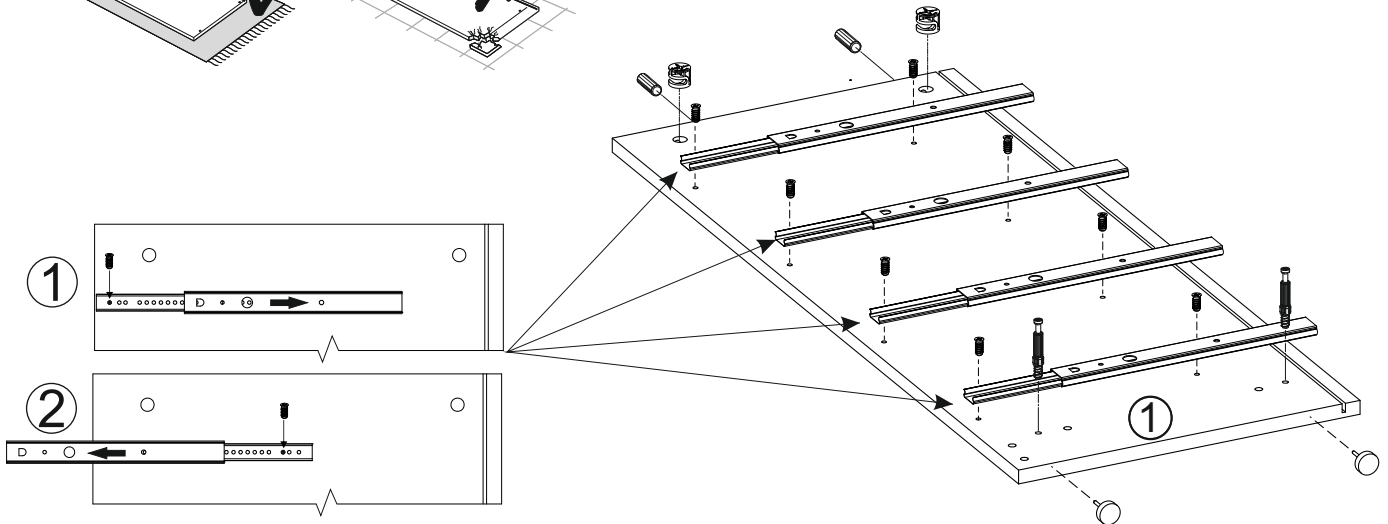
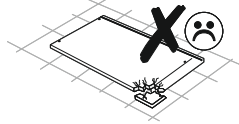
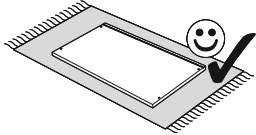
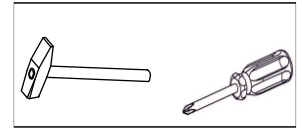

1

3003605 x8  <b>8x35</b>	3002942 x4 	3001728 x4 
3000406 x4 	3000564 x16  <b>6,3x13</b>	3003790 x8 



2

x4	3003605	x4	3002942	x4	3001728
	<b>8x35</b>				

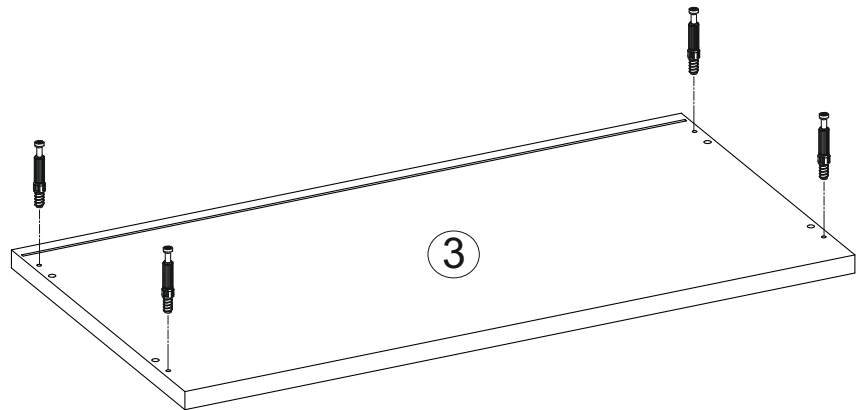
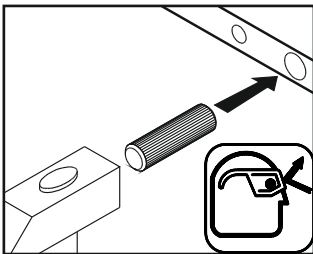
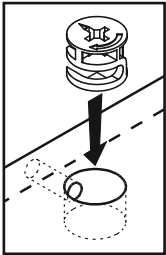
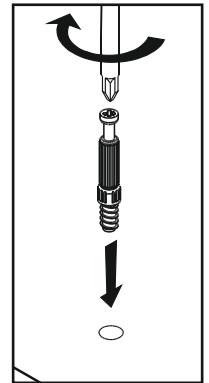
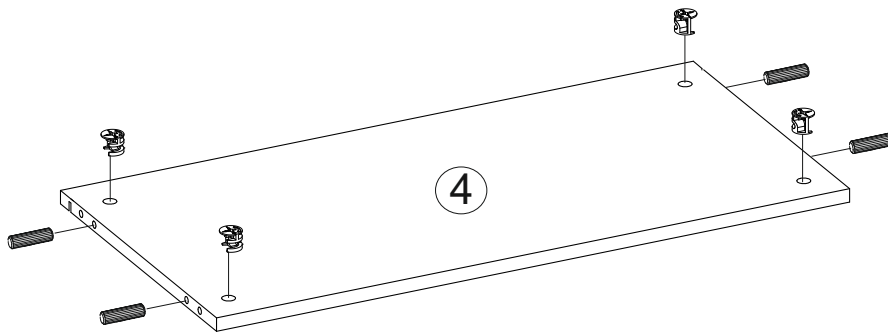
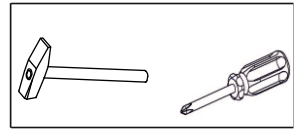

3

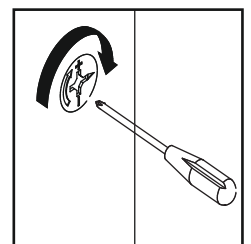
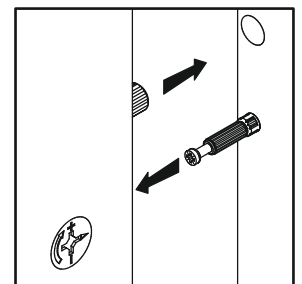
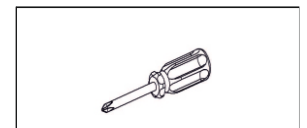
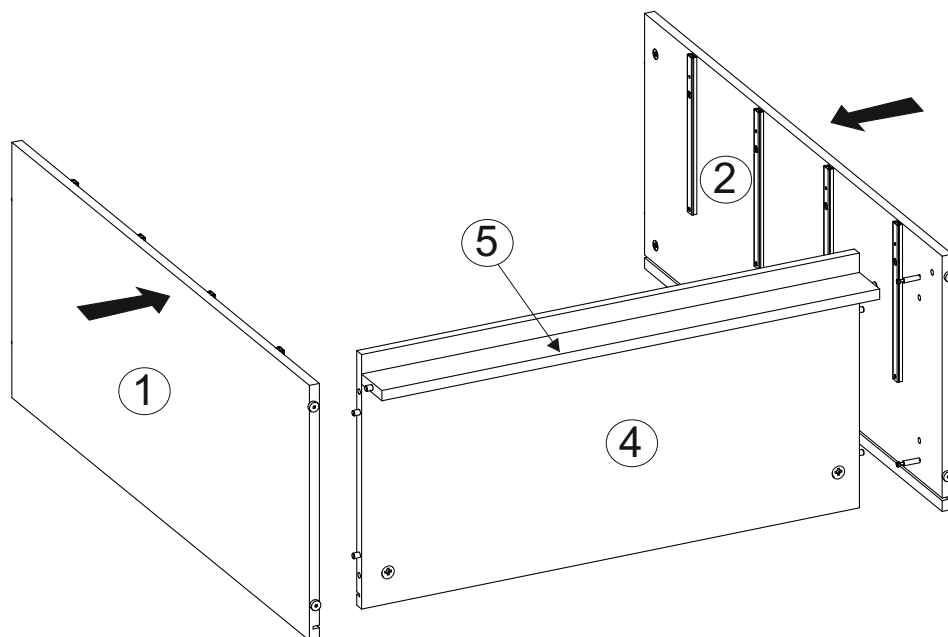

4

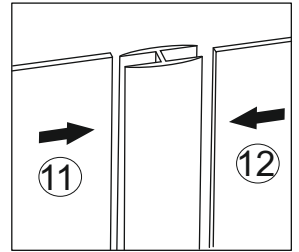
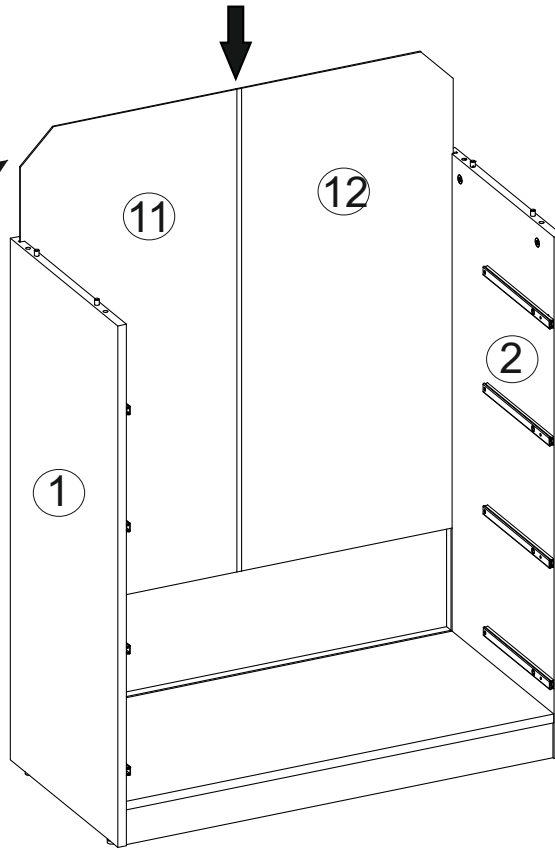
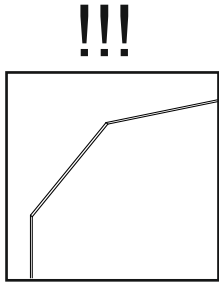
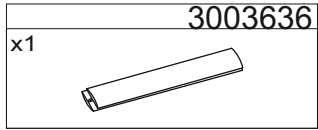

5

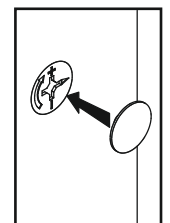
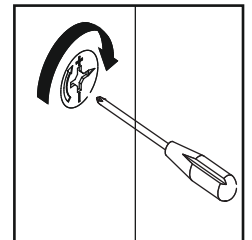
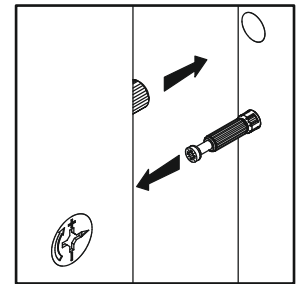
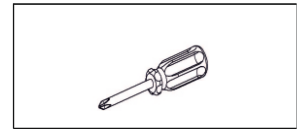
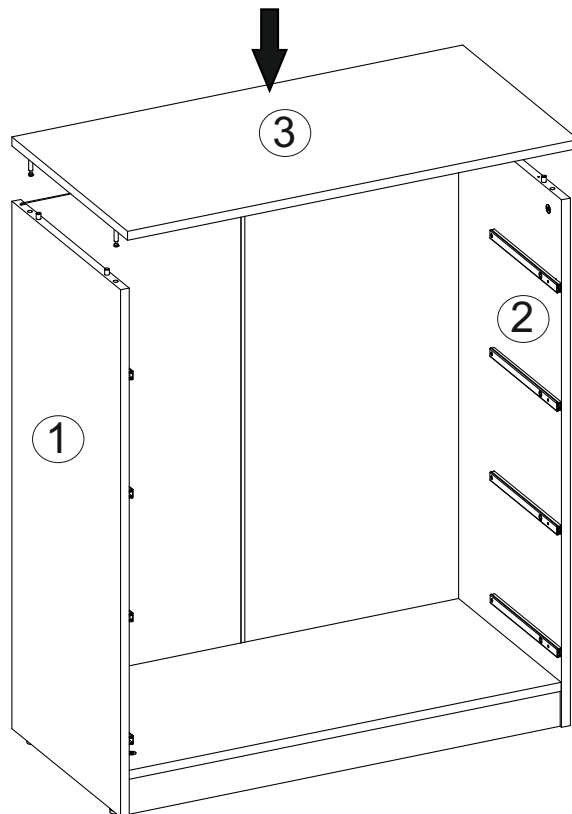
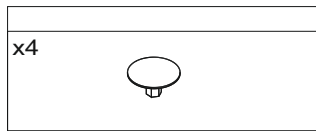

6

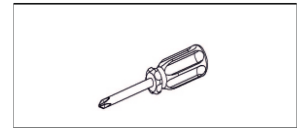
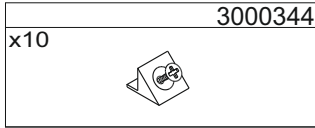

A=B

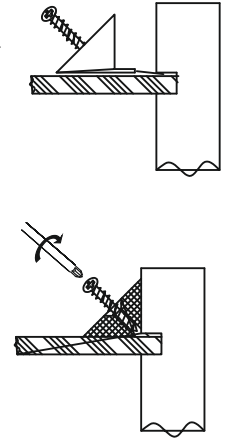
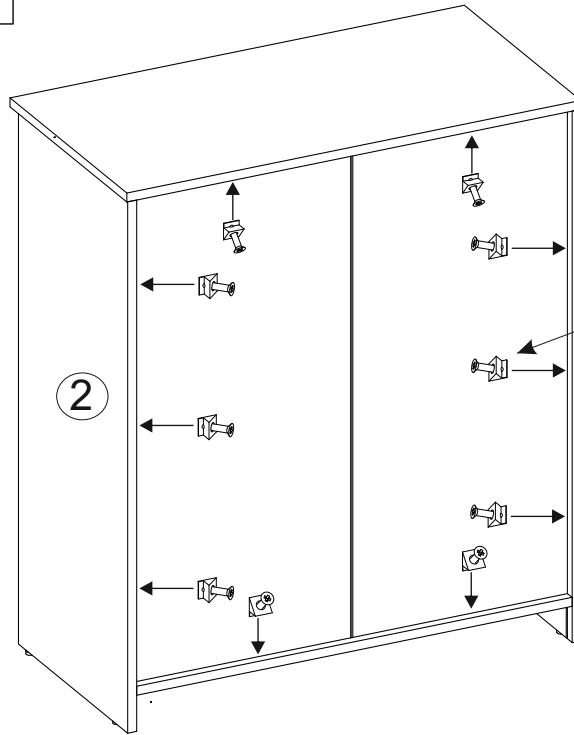
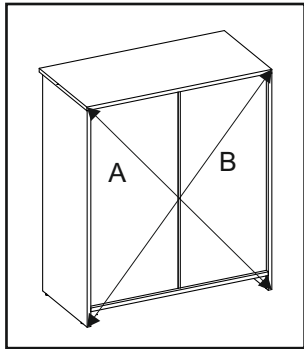

7

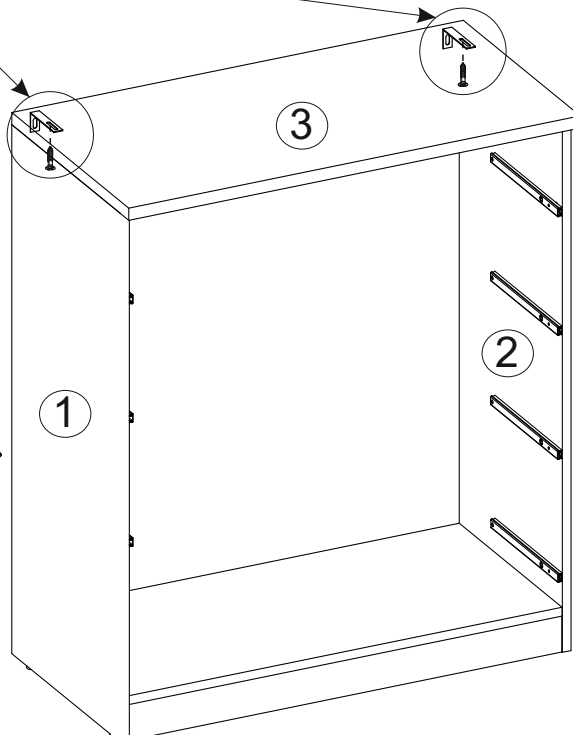
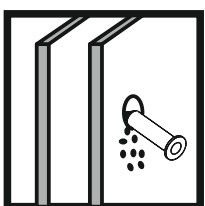
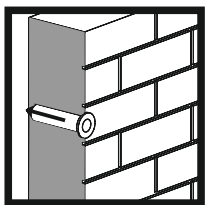
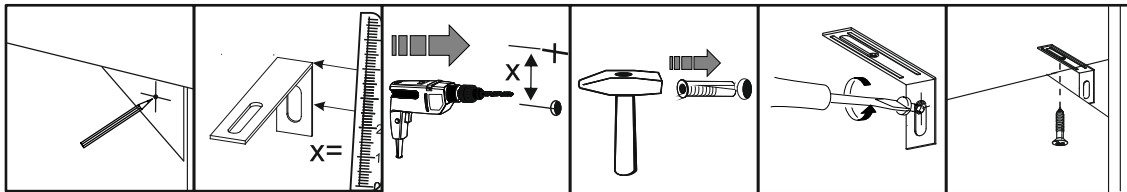
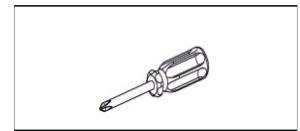
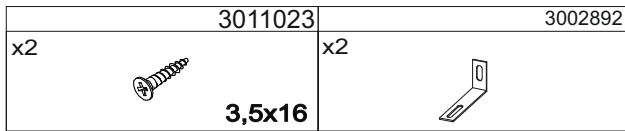

Installation shall be carried out exactly according to the manufacturer's instructions-otherwise a safety risk can occur if incorrectly installed; **WARNING** In order to prevent overturning this product must be used with the wall attachment device provided.



8

x8	3000534	7x50
x1	3000214	

x8	3005048	6x30
----	---------	------

x1	3000331	
----	---------	--

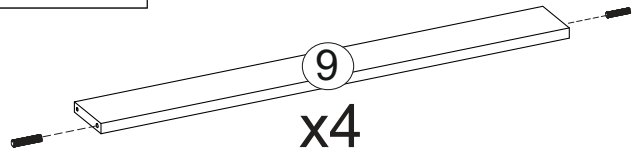
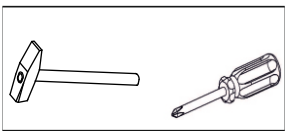

x4

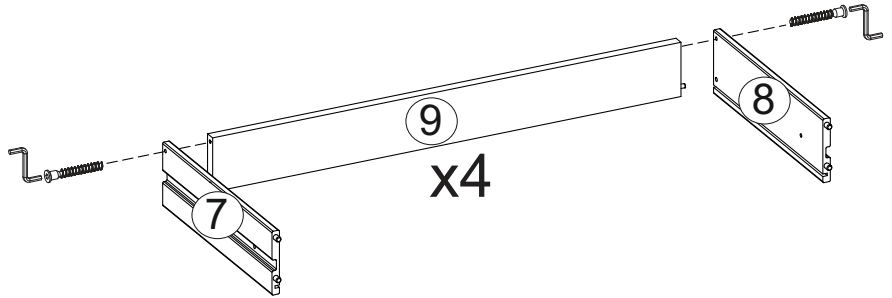
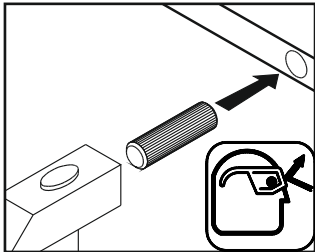

x4

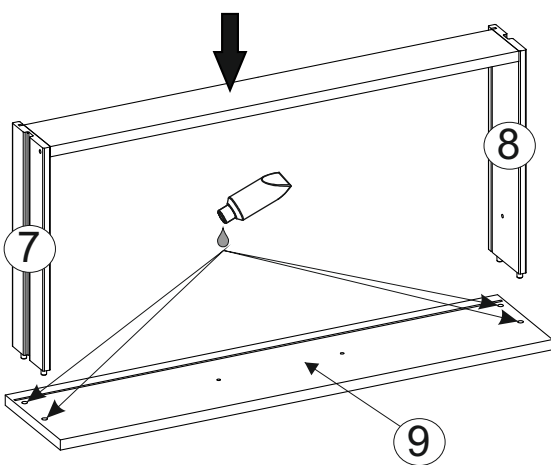

x4

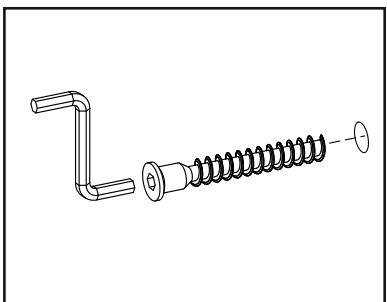
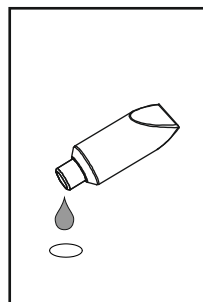

9

x24	3003843	UP 3x20
-----	---------	---------

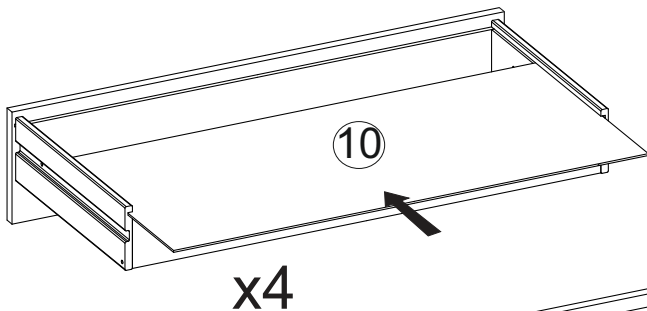

x4

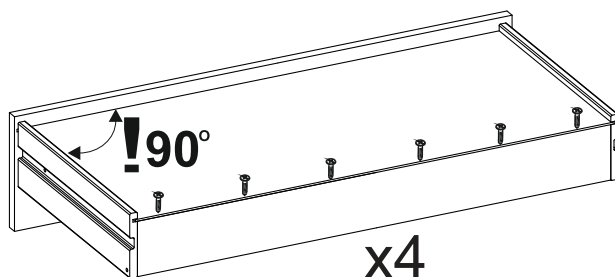

x4

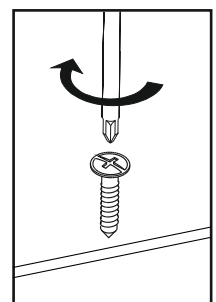

10

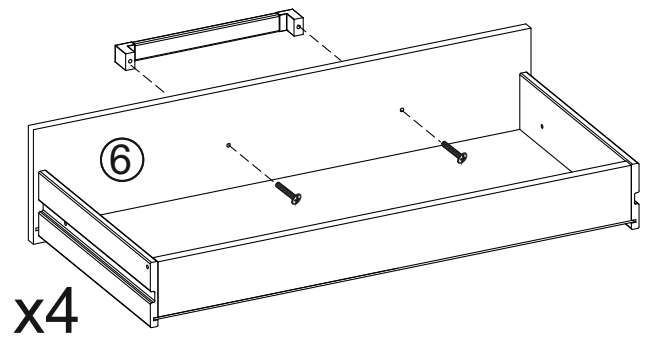
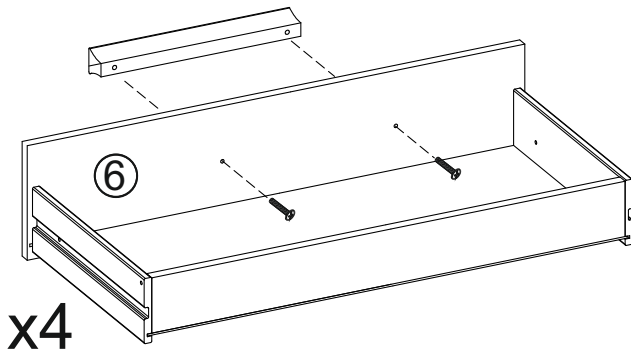
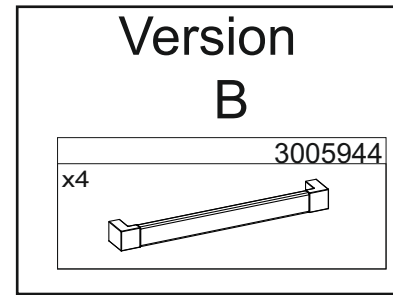
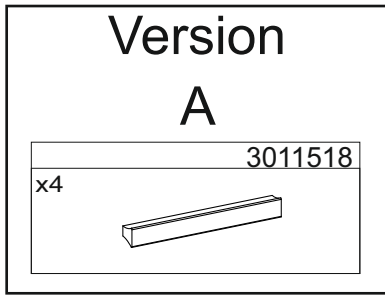
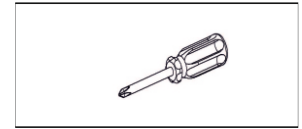
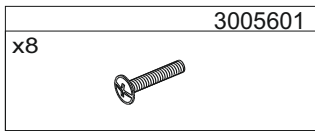

11

