

# Birlea

Suppliers of inspiration

## Assembly Instructions

---

*Thank you* for  
purchasing a  
Birlea product.

For a chance to win a *Love 2 Shop* voucher simply post a picture of your new product on your preferred social channels tagging Birlea Furniture and using the hashtag **#ShareYourStyle** and **#Birlea**. One winner will be selected at random each month.

*To view our full terms and conditions please visit our website. [www.birlea.com](http://www.birlea.com)*

---

### **Are you happy with your purchase?**

**Yes:** That's great, we would love to hear more from you. Please leave us a review on our social media channels or Trustpilot. Your feedback will be greatly appreciated.

**No:** If for any reason there is something missing, indifferent or incorrect with your order, please contact the retailer you purchased the item from. We will work with the retailer to resolve your issue as quickly as possible.



[www.birlea.com](http://www.birlea.com)

## **ASSEMBLY INSTRUCTIONS** **HOUSTON 2 DOOR 1 DRAWER WARDROBE**

**IMPORTANT : READ THESE INSTRUCTIONS CAREFULLY BEFORE ATTEMPTING TO ASSEMBLE OR USE YOUR HOUSTON 2 DOOR 1 DRAWER WARDROBE.**

**PLEASE KEEP THESE INSTRUCTIONS FOR FUTURE REFERENCE.**

### **ASSEMBLY:**

Assembly should be carried out with this item laying flat, not standing upright.

Assemble on a soft, clean surface to prevent damages.

To erase the numbers printed on the pieces, use the rubber inside the accessories pack.

### **HEALTH & SAFETY:**

DO NOT use this product if any parts are missing, damaged or worn.

DO NOT use this product unless all fixings are secured.

Always use on a level, even surface.

### **CARE & MAINTENANCE:**

Periodically check all screws & fixings to ensure they are secure.

DO NOT push this product as this will cause damage.

Always lift this product with two people to repositions.

Keep any sharp objects away from this product.

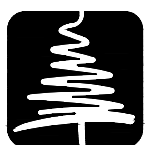
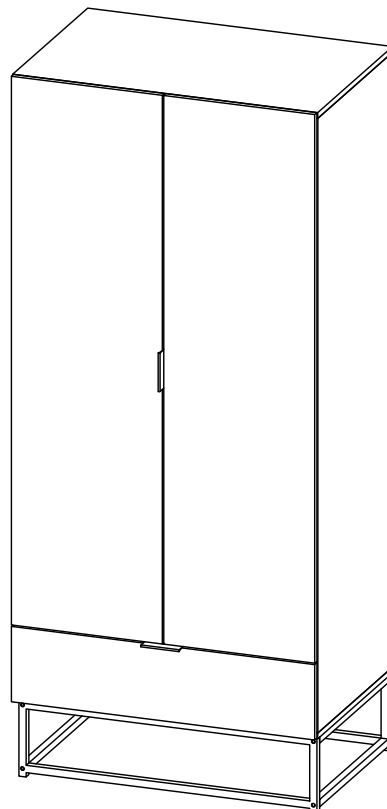

**Birlea**





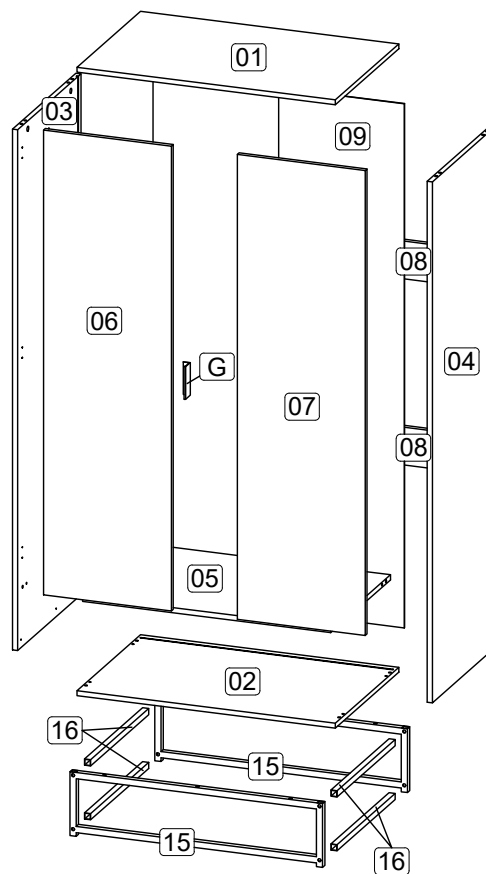
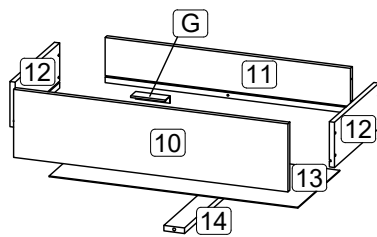









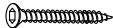



Suppliers of inspiration

[www.birlea.com](http://www.birlea.com)

**Parts List**

Part	Description	Box	Qty
01	Top panel	2	1
02	Bottom panel	2	1
03	Side panel ( Left )	1	1
04	Side panel ( Right )	1	1
05	Middle panel	2	1
06	Door panel ( Left )	1	1
07	Door panel ( Right )	1	1
08	Back bone	1	2
09	Back panel	1	1
10	Drawer front	2	1
11	Drawer back	2	1
12	Drawer side	2	2
13	Drawer bottom	2	1
14	Drawer bone	2	1
15	Metal frame	2	2
16	Metal bone	2	4

**Hardware List ( BOX 2 )**

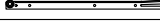
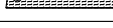
Part	Description	Qty
A1	Cam lock 	18
A2	Minifix screw 	18
A3	Plastic cap 	18
B	M8 x 30mm Wood Dowel 	12
C	M6 x 50mm CSK Cap Wood screw 	4
D	M3.5 x 16mm C.B Screw 	42
E	M3 x 12mm C.B Screw 	4
F	Allen key M4 	1
G	4020 L BAR (100MM) 	2
H	5/8 Hinges 	6
I	JCBC screw M6 x 30mm 	6
J	JCBC screw M6 x 40mm 	8
K1	Stud 192 	8
K2	Stud 192 screw 	8
L	M4 x 38mm C.B Screw 	8
M	433 Oval tube bracket 	2
N	433 Oval paip 	1
O1	14" Drawer slide (Left / Right) 	2
O2	14" Drawer slide (Left / Right) 	2
P	8" x 1" PP tape 	2
Q	Wall plug 	-

**\*\* You will need a small mallet and a screwdriver for assembly.**

**\*\* Some screws and wooden dowel may remain.**

**\*\* Note : To secure the item to the wall, hardware L ( 2 pcs ) and Q ( 2 pcs ) are not provided.**

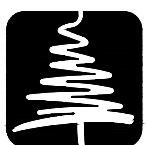

# Birlea

Suppliers of inspiration

Step 1: Prepare these parts for assembly using hardware parts A1, A2, B, D, H, M and O1.  
**DO NOT use any power tools as this may damage the frame and will invalidate any claim.**

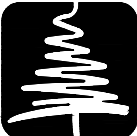
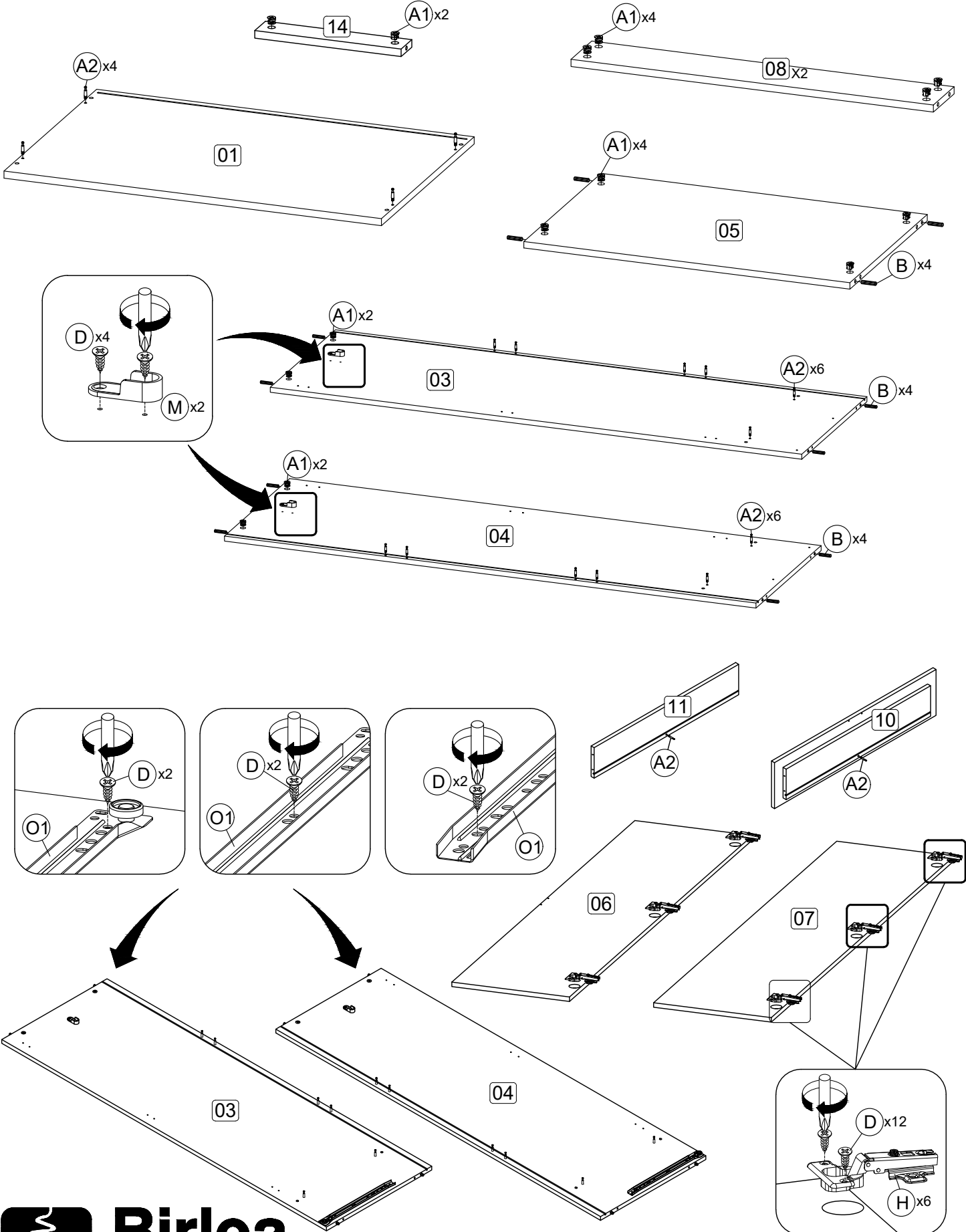

**Step 2:** Attach middle panel (5) and back bone (8) to side panel (3) using hardware A1 and A2 with a screwdriver (not provided).

**DO NOT use any power tools as this may damage the frame and will invalidate any claim.**

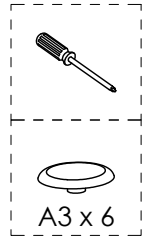
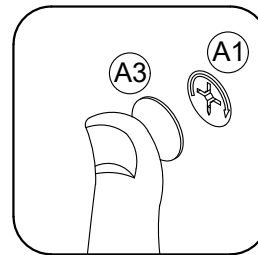
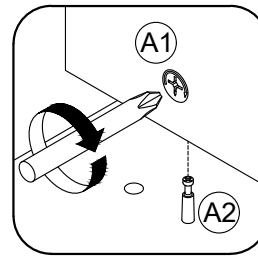
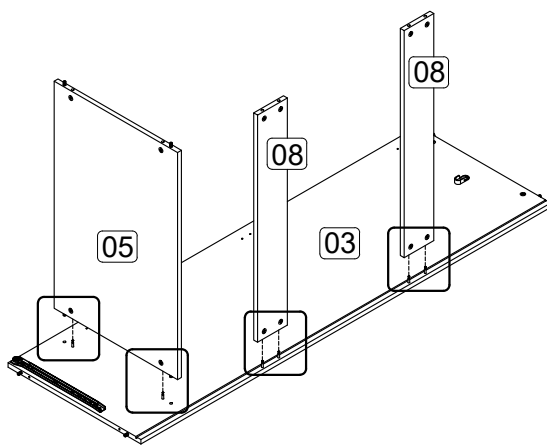

**Step 3:** Insert back panel (9) along the slot.

**DO NOT use any power tools as this may damage the frame and will invalidate any claim.**

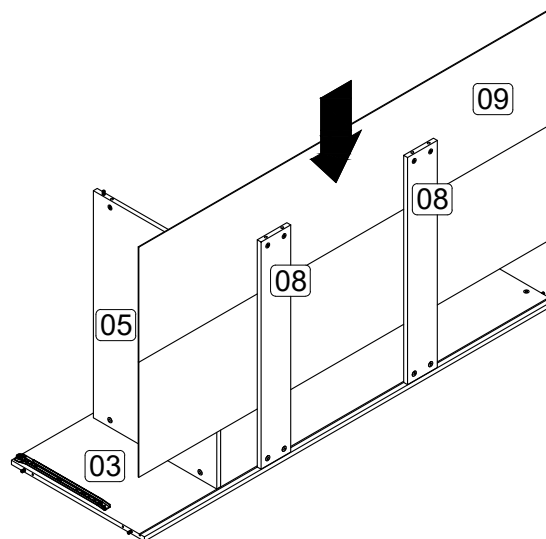

**Step 4:** Attach middle panel (5) and back bone (8) to side panel (4) using hardware A1 and A2 with a screwdriver (not provided).

**DO NOT use any power tools as this may damage the frame and will invalidate any claim.**

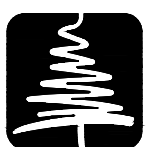
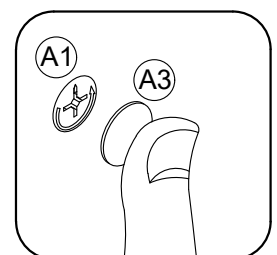
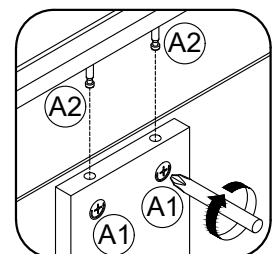
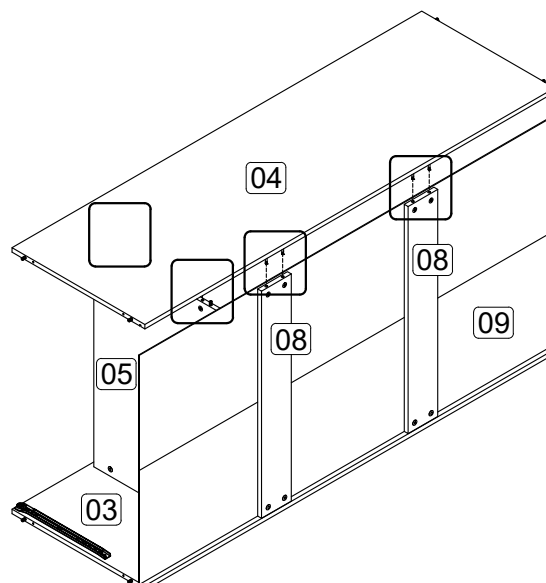
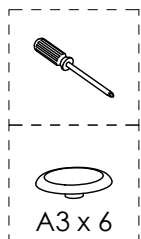

**Birlea**

Suppliers of inspiration

**Step 5:** Attach side panel (3) and (4) to top panel (1) using hardware A1 and A2 with a screwdriver (not provided).

**DO NOT use any power tools as this may damage the frame and will invalidate any claim.**

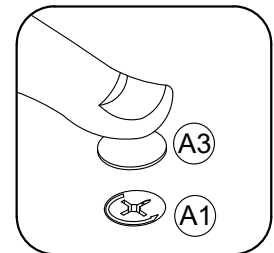
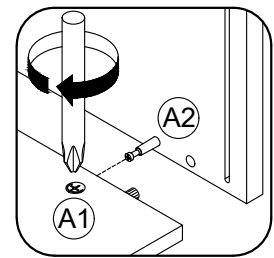
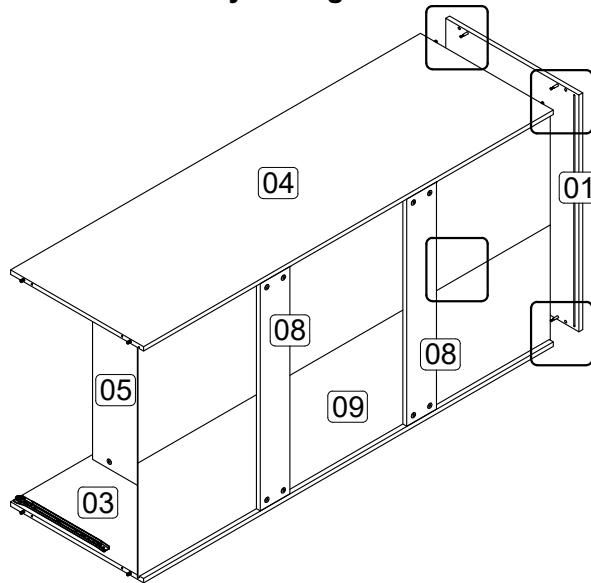
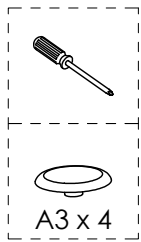

**Step 6:** Attach bottom panel (2) to side panel (3) and (4) using hardware C and F.

**DO NOT use any power tools as this may damage the frame and will invalidate any claim.**

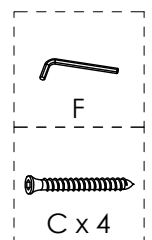
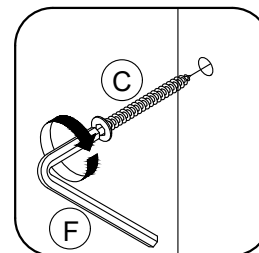
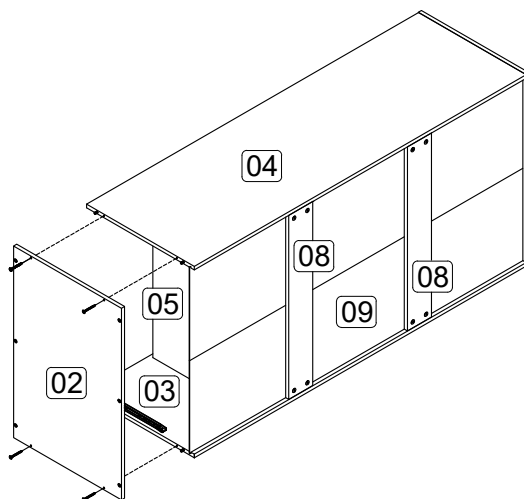

**Step 7:** Attach hardware K1 into top panel (1), bottom panel (2), side panel (3) and (4) using hardware K2 with a screwdriver (not provided).

**DO NOT use any power tools as this may damage the frame and will invalidate any claim.**

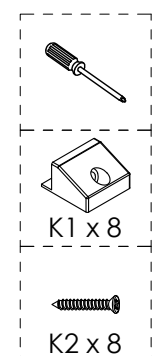
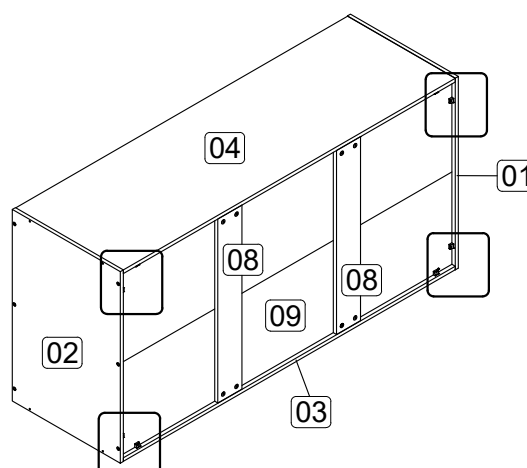
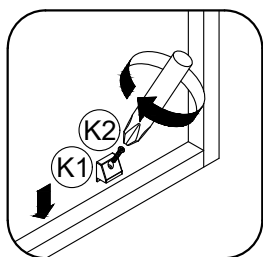

**Birlea**

Suppliers of inspiration

**Step 8:** Attach metal frame (15) to metal bone (16) using hardware F and J.

**DO NOT use any power tools as this may damage the frame and will invalidate any claim.**

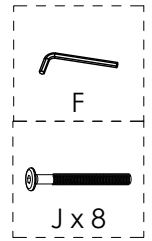
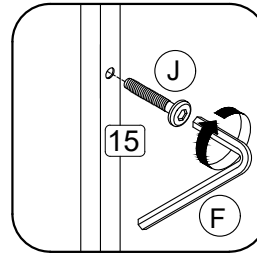
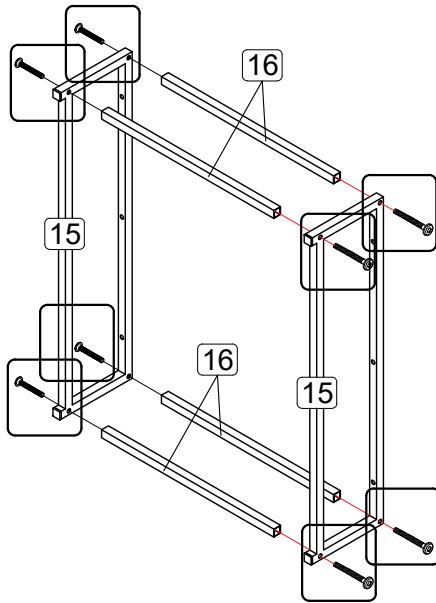

**Step 9:** Attach metal frame (15) to bottom panel (2) using hardware F and I.

**DO NOT use any power tools as this may damage the frame and will invalidate any claim.**

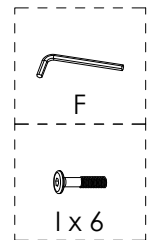
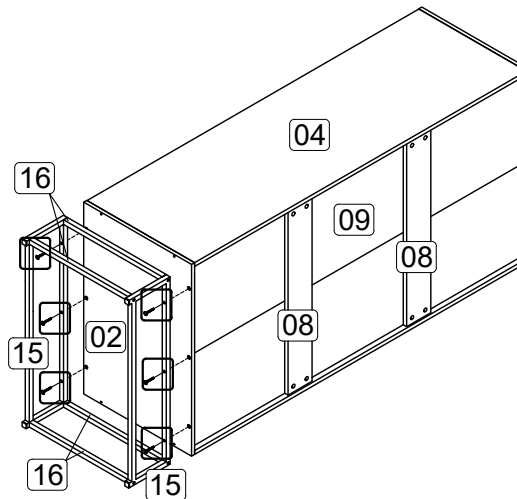
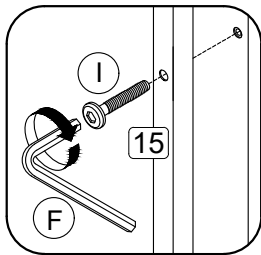

**Step 10:** Attach hardware N into hardware M.

**DO NOT use any power tools as this may damage the frame and will invalidate any claim.**

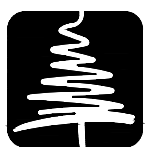
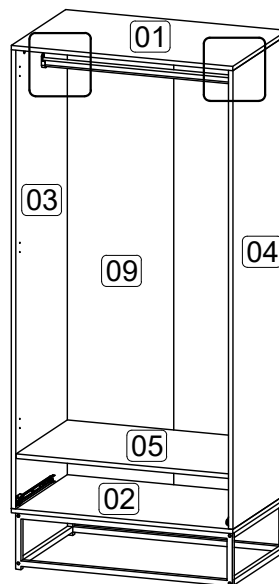
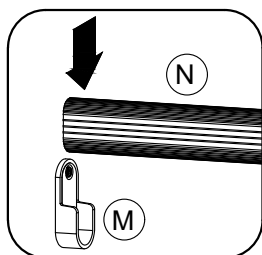

**Birlea**

Suppliers of inspiration

**Step 11:** Fix hardware G onto door panel (6) and drawer front (10) using hardware E with a screwdriver (not provided).

**DO NOT use any power tools as this may damage the frame and will invalidate any claim.**

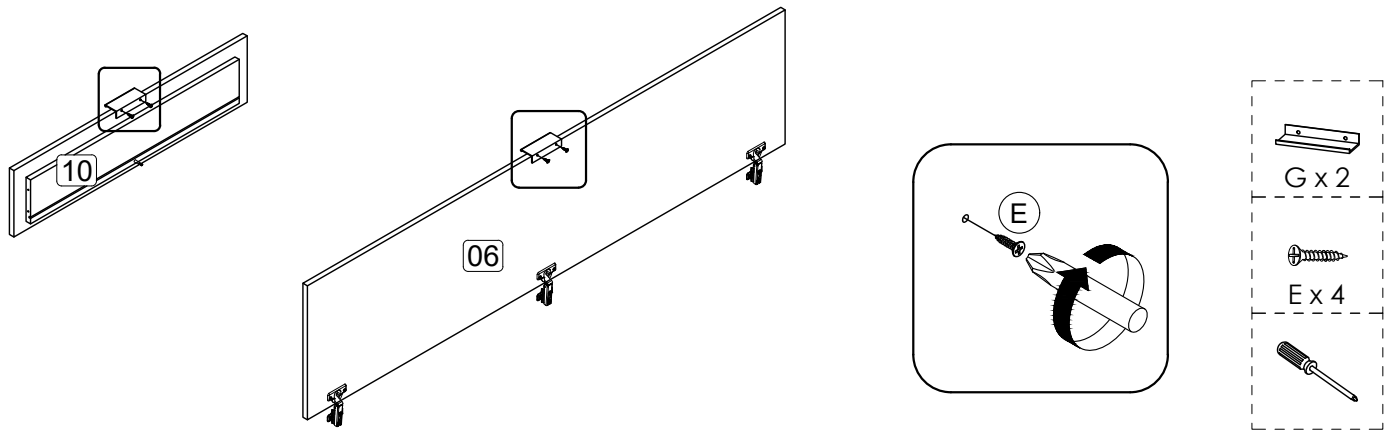

**Step 12:** Attach door panel (6) and (7) to side panel (3) and (4) using hardware D with a screwdriver (not provided).

**DO NOT use any power tools as this may damage the frame and will invalidate any claim.**

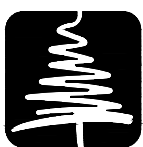
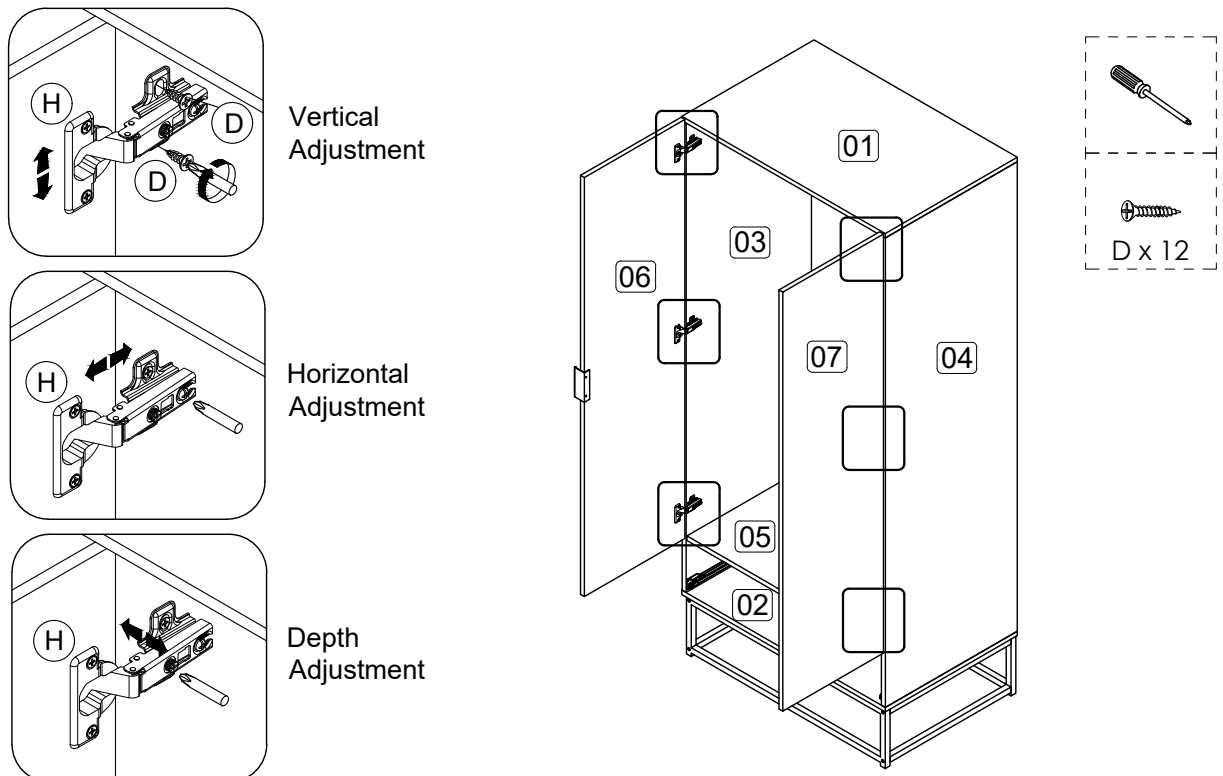

**Birlea**

Suppliers of inspiration



**Step 13:** Attach drawer bone (14) to drawer front (10) and drawer back (11) using hardware A1 and A2 with a screwdriver (not provided).

**DO NOT use any power tools as this may damage the frame and will invalidate any claim.**

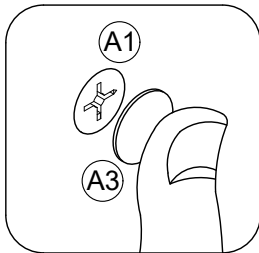
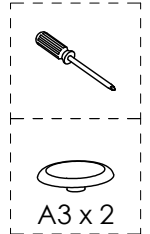
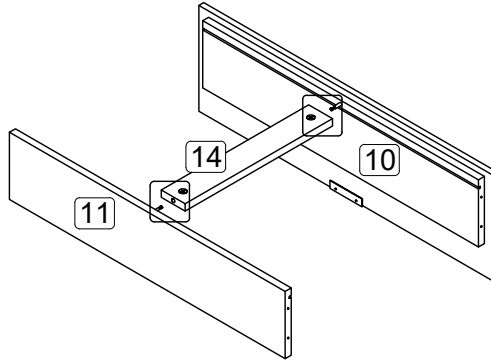
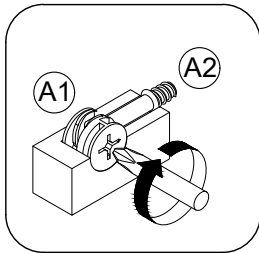

**Step 14:** Attach the 1x Drawer Side (12) to the Drawer Front (10) and Drawer Back (11) using hardware L. Then insert the Drawer Bottom (13) and attach the other 1x Drawer Side (12) to the Drawer Front (10) and Drawer Back (11) using hardware L. Attach the hardware O2 to the Drawer Sides (12) using hardware D.

**DO NOT use any power tools as this may damage the frame and will invalidate any claim.**

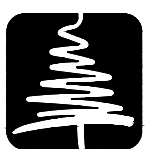
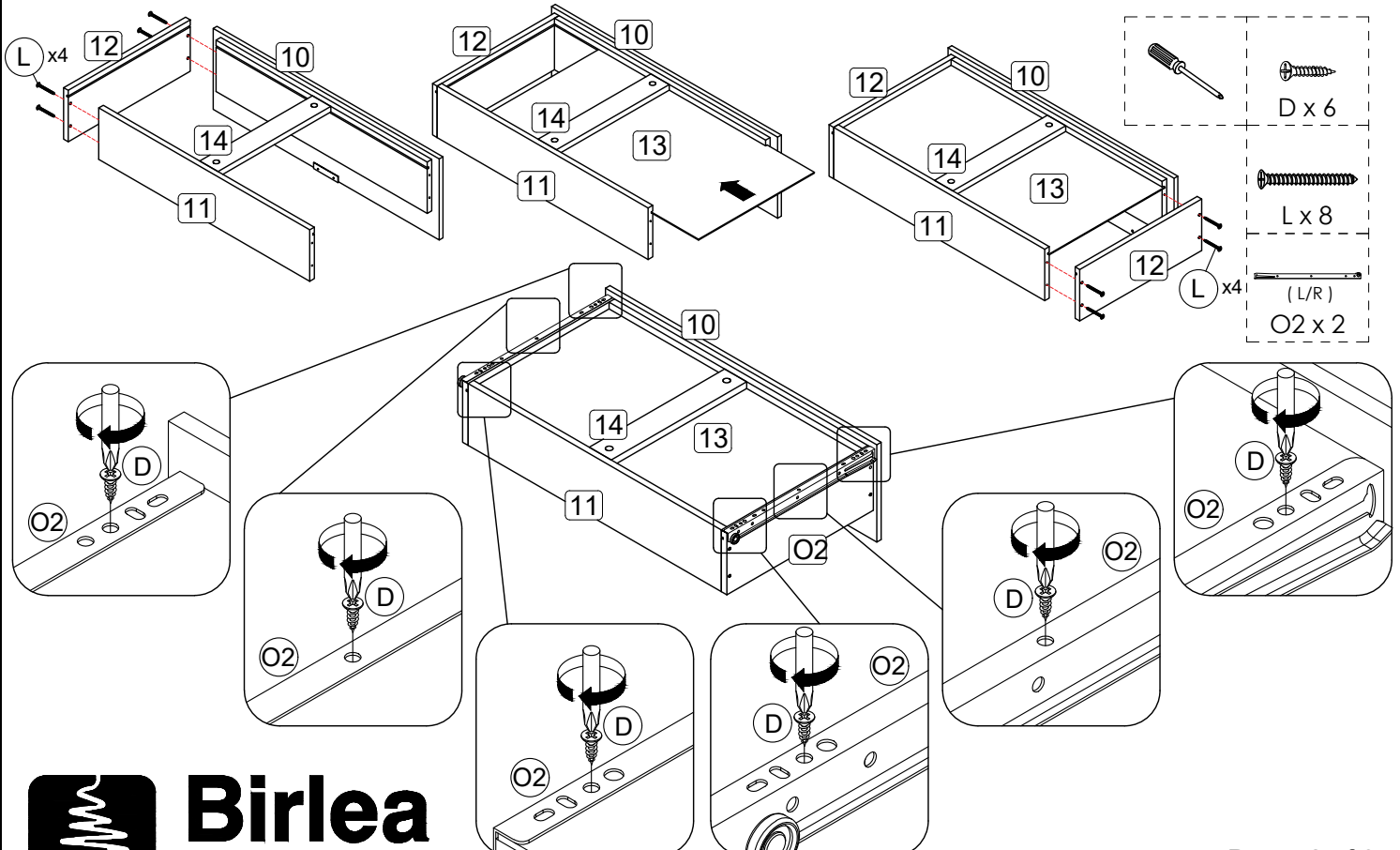

**Birlea**

Suppliers of inspiration

**Step 15:** Assemble the drawer in place along the drawer slides.

**DO NOT use any power tools as this may damage the frame and will invalidate any claim.**

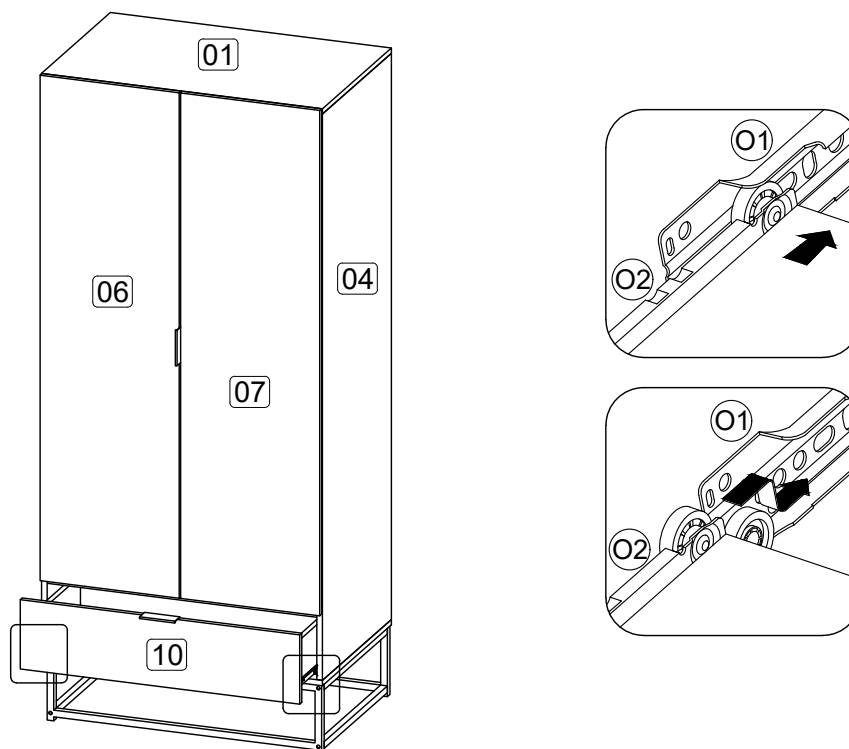

**Step 16:** To secure the item to the wall use hardware L, P and Q using a screwdriver (not provided).

Then attach hardware part P to top panel (1) using hardware D with a screwdriver (not provided).

**DO NOT use any power tools as this may damage the frame and will invalidate any claim.**

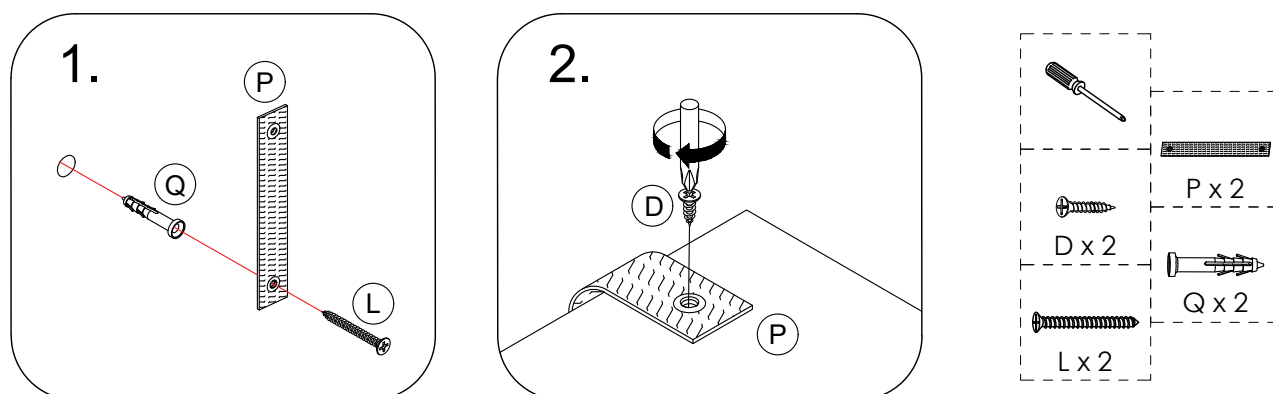

**PLEASE NOTE** that wall fixings are not supplied as different wall materials require different fixing devices. You must use fixings devices suitable for the type of wall you intend to mount product to. Ensure the head of any screw used has a diameter greater than the mounting hole and the fixing is safe and secure before use.

Birlea Furniture advise you use the wall straps provided to further enhance the safety of this product.

### Additional Information:

- For complete product information, images and dimension diagrams please visit the website [www.birlea.com](http://www.birlea.com)
- If you have any issues with your item please contact the retailer directly you purchased it from who will be able to resolve any issues with Birlea.
- Why don't you send us photos of your assembled furniture to [info@birlea.com](mailto:info@birlea.com) to be shared in our #birleahome feature on instagram.

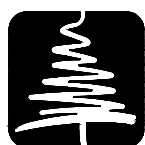

# Birlea

Suppliers of inspiration